



# Venting and Flaring Research Study Report

JANUARY | 2017



## Analysis of Potential Opportunities to Reduce Venting and Flaring on the OCS

Prepared by Argonne Venting and Flaring Research Team

## BSEE Venting and Flaring Research Study

---

### **Disclaimer**

This report was prepared by Argonne National Laboratory (ANL) under contract to the Department of Energy (DOE) through an inter-agency agreement between the Department of the Interior, Bureau of Safety and Environmental Enforcement (BSEE) and the DOE. The opinions, findings, conclusions, and recommendations expressed in the report are those of the authors and they do not necessarily reflect the views or policies of BSEE.

This report was prepared as an account of work sponsored by an agency of the United States Government. Neither the United States Government nor any agency thereof, nor UChicago Argonne, LLC, nor any of their employees or officers, makes any warranty, express or implied, or assumes any legal liability or responsibility for the accuracy, completeness, or usefulness of any information, apparatus, product, or process disclosed, or represents that its use would not infringe privately owned rights. Reference herein to any specific commercial product, process, or service by trade name, trademark, manufacturer, or otherwise, does not necessarily constitute or imply its endorsement, recommendation, or favoring by the United States Government or any agency thereof. The views and opinions of document authors expressed herein do not necessarily state or reflect those of the United States Government or any agency thereof, Argonne National Laboratory, or UChicago Argonne, LLC



## TABLE OF CONTENTS

<b>Table of Contents</b> .....	<b>iv</b>
<b>List of Figures</b> .....	<b>vi</b>
<b>List of Tables</b> .....	<b>vii</b>
<b>Acronyms and Abbreviations</b> .....	<b>viii</b>
<b>Introduction</b> .....	<b>1</b>
<b>Background</b> .....	<b>1</b>
<b>Study Objectives</b> .....	<b>2</b>
<b>Overview of Current Venting and Flaring Regulations</b> .....	<b>3</b>
<b>Issue Background and Regulatory Challenges</b> .....	<b>3</b>
<b>International Regulatory Best Practices</b> .....	<b>4</b>
<b>Current Offshore Regulations and Guidance in the U.S.</b> .....	<b>9</b>
<b>Estimation of Venting and Flaring Volumes</b> .....	<b>12</b>
<b>Primary Data Sources</b> .....	<b>12</b>
<b>Trends in Oil and Gas Production and Associated Venting and Flaring Volumes</b> .....	<b>13</b>
<b>Analysis of Venting and Flaring Volumes by Facility Type</b> .....	<b>20</b>
<b>Comparing Monthly Spikes in Venting and Flaring Volumes with Requests Approved by BSEE</b> .....	<b>24</b>
<b>Forecasted Venting and Flaring Volumes</b> .....	<b>29</b>
<b>Gas Capture Technology</b> .....	<b>36</b>
<b>Technology Options</b> .....	<b>36</b>
<b>Technology Briefing Template</b> .....	<b>39</b>
<b>Cost-Benefit Analysis</b> .....	<b>40</b>
<b>CBA Methodology</b> .....	<b>41</b>
Input Data and Assumptions .....	41
Single-Complex Analysis of Technology Benefits and Costs .....	47
OCS-Wide Analysis of Technology Benefits and Costs .....	50
<b>CBA Results by Complex</b> .....	<b>55</b>
Technology Ranking by NPV for Individual Complex .....	55
Contribution of Gas Revenue and Avoided Emissions to Technology Benefits .....	55
Identifying Cost-Beneficial Applications of Gas Capture Technologies .....	58
Break-Even Social Cost of Carbon .....	59
<b>Aggregated CBA Results for OCS</b> .....	<b>61</b>
OCS-Wide CBA Results for Base Case .....	61
OCS-Wide CBA Results for Alternative Scenarios .....	63
Summary Observations from Technology Analysis .....	66
<b>Conclusions and Recommendations</b> .....	<b>67</b>
<b>Observations</b> .....	<b>67</b>
<b>Recommendations</b> .....	<b>70</b>



**Appendix I: Regulatory Status, Developments, and Trends Regarding Venting and Flaring of Natural Gas in Oil and Gas Production**

**Appendix II: Methane Emission Reduction Technology Briefings**

**Appendix III: Change to OGOR-B Reporting Requirements for Flaring and Venting, Form MMS-4054**

## LIST OF FIGURES

Figure 1: Illustration of Link Between OGOR and TIMS Data Tables to Create Initial AVF-DB.

Figure 2: Natural Gas Production in the Gulf of Mexico.

Figure 3: Oil Production in the Gulf of Mexico.

Figure 4: Top 30 Flaring Countries.

Figure 5: Flaring Intensity of Top 30 Flaring Countries.

Figure 6: Typical Types of Platforms in Use on the OCS (1 of 2).

Figure 7: Typical Types of Platforms in Use on the OCS (2 of 2).

Figure 8: Monthly Flaring Volumes by Facility on the OCS during 2011–2015.

Figure 9: Number of Approved Events to Exceed Flaring Limit.

Figure 10: Volume Flared for Approved Events by Type.

Figure 11: Number of Approved Events to Exceed Venting Limit.

Figure 12: Volume Vented for Approved Events by Type.

Figure 13: Estimated Annual Flaring Volumes for Low E&D Scenario.

Figure 14: Estimated Annual Venting Volumes for Low E&D Scenario.

Figure 15: Estimated Annual Flaring Volumes for Medium E&D Scenario.

Figure 16: Estimated Annual Venting Volumes for Medium E&D Scenario.

Figure 17: Estimated Annual Flaring Volumes for High E&D Scenario.

Figure 18: Estimated Annual Venting Volumes for High E&D Scenario.

Figure 19: Technology Briefing Checklist.

Figure 20: Conceptual Design of Technology CBA Model.

Figure 21: Alternative Natural Gas Price Forecasts.

Figure 22: Alternative Oil Price Forecasts.

Figure 23: Quantification of Technology Benefits for Specific Floating Structure with Base Case Assumptions

Figure 24: NPV Distribution by Complex for Compressor Off - Maintain Pressure Technology.

Figure 25: NPV Distribution by Complex for Static Seals Technology.

Figure 26: CO<sub>2</sub> Equivalent Avoided Emissions as Percent of OCS-Wide Total (Base Case).

Figure 27: CO<sub>2</sub> Equivalent Avoided Emissions (Base Case and Alternative Scenarios).

Figure 28: Total Value of Technologies with Positive NPVs (Base Case and Alternative Scenarios).

## LIST OF TABLES

Table 1: Annual Venting and Flaring Volumes by Disposition as Reported in OGOR-B for OCS.

Table 2: Estimated Venting and Flaring Volumes as a Percent of Gas Production by Structure Type.

Table 3: Flaring Profile for Floating Structures.

Table 4: Gas Capture Technologies Evaluated in Cost-Benefit Analysis.

Table 5: Technical and Economic Characteristics for Evaluated Gas Capture Technologies.

Table 6: Emission Factors for CH<sub>4</sub> and CO<sub>2</sub> Relative to Amount of Gas Captured.

Table 7: Break-Even Social Cost of Carbon by Technology with Base Case Assumptions.

Table 8: Aggregate Technology CBA Results with Base Case Assumptions.

Table 9: Avoided Emissions by Technology for Base Case and Alternative Scenarios.

## ACRONYMS AND ABBREVIATIONS

BID	Bureau Interim Directive
BOEM	Bureau of Ocean Energy Management
BOEMRE	Bureau of Ocean Energy Management
bopd	Barrels of Oil Per Day
BSEE	Bureau of Safety and Environmental Enforcement
CBA	Cost-Benefit Analysis
CFR	Code of Federal Regulations
CH <sub>4</sub>	Methane
CO <sub>2</sub>	Carbon Dioxide
CO <sub>2e</sub>	Carbon Dioxide Equivalent
CT	Compliant Tower
EPA	United States Environmental Protection Agency
ESP	Electric Submersible Pump
E&D	Exploration and Development
FP	Fixed Platform
FPS	Floating Production System
FPSO	Floating Production, Storage and Offloading
GAO	Government Accountability Office
GGFR	Global Gas Flaring Reduction
GOADS	Gulfwide Offshore Activities System
GOM	Gulf of Mexico
GOR	Gas/Oil Ratio
GWP	Global Warming Potential
kg	Kilogram
lb	Pound
Mcf	Thousand cubic feet
Mcfd	Thousand cubic feet per day

---

Mcfh	Thousand cubic feet per hour
MMcf	Million cubic feet
NPV	Net Present Value
O&G	Oil and Gas
OCS	Outer Continental Shelf
OGOR-A	Oil and Gas Operations Reports Part A
OGOR-B	Oil and Gas Operations Reports Part B
OMB	Office of Management and Budget
ONRR	Office of Natural Resources Revenue
RCS	Resource Conservation Section
SC-CO <sub>2</sub>	Social Cost of Carbon
scf	Standard cubic feet. The “s” represents standard, which means at 60deg F and 14.73 psi (1 atmosphere of pressure). The “s” is implied in MCF.
TLP	Tension Leg Platform
TIMS	Technical Information Management System
TMV	Typical Monthly Volume
Ton	Short ton (2000 pounds)
Tonne	Metric ton (1000 kilograms)

THIS REPORT WAS INADVERTENTLY DISSEMINATED IN THE PUBLIC DOMAIN/ONLINE SINCE 07/2021 WITHOUT A DISCLAIMER. DISCLAIMER HAS BEEN ADDED  
– “THIS INFORMATION IS DISTRIBUTED SOLELY FOR THE PURPOSE OF PEER REVIEW UNDER APPLICABLE INFORMATION QUALITY GUIDELINES. IT HAS NOT BEEN FORMALLY DISSEMINATED BY BSEE. IT DOES NOT REPRESENT AND SHOULD NOT BE CONSTRUED TO REPRESENT ANY AGENCY DETERMINATION OR POLICY.”

## INTRODUCTION

During oil and gas production on the federal Outer Continental Shelf (OCS), natural gas is often vented or flared. This imposes costs both to the environment in the adverse effects of pollutant emissions and to society in the energy value of the lost gas.

## BACKGROUND

In October 2010, the United States Government Accountability Office (GAO) issued a report entitled “Opportunities Exist to Capture Vented and Flared Natural Gas, Which Would Increase Royalty Payments and Reduce Greenhouse Gases.” This 2010 GAO report contained the following recommendations for the Bureau of Ocean Energy Management (BOEMRE) to improve data and reduce emissions from oil and gas production facilities on the OCS<sup>1</sup>:

- Recommendation 1—BOEMRE should reconcile differences in reported offshore venting and flaring volumes between the Oil and Gas Operations Report (OGOR) and the Gulfwide Offshore Activities Data System (GOADS) data systems. BOEMRE should make adjustments to ensure the accuracy of these systems.
- Recommendation 2—BOEMRE should consider extending its requirement that gas be captured where economical to "lease-use" sources of gas.
- Recommendation 3—BOEMRE should assess the potential uses of venting and flaring reduction technologies for minimizing the waste of natural gas, in advance of production where applicable and not solely for purposes of air quality.
- Recommendation 4—BOEMRE should consider expanding its use of infrared cameras, where economical, to improve the reporting of emission sources and to identify opportunities to minimize lost gas.
- Recommendation 5—BOEMRE should consider collecting information on the extent to which larger operators use venting and flaring reduction technology. BOEMRE should periodically review this information to identify opportunities for oil and gas operators to reduce their emissions and should use existing information in the GOADS data system for this same purpose.

On October 1, 2011, BOEMRE reorganized into two new bureaus, the Bureau of Safety and Environmental Enforcement (BSEE) and the Bureau of Ocean Energy Management (BOEM). At this time, recommendations 2–5 were assigned to BSEE and recommendation 1 to BOEM. All five recommendations have since been implemented.

---

<sup>1</sup> GAO, *Federal Oil and Gas Leases, Opportunities Exist to Capture Vented and Flared Natural Gas, Which Would Increase Royalty Payments and Reduce Greenhouse Gases*, GAO-11-34, October 2010, page 33.



In addressing the recommendations assigned by the GAO, BSEE solicited the assistance of BOEM’s Economics Division. This division helped evaluate opportunities for reducing methane emissions resulting from oil and gas (O&G) production in the Gulf of Mexico (GOM). Reported findings from the study’s preliminary cost-benefit analyses suggest that flaring currently vented methane and replacing high-bleed pneumatic controllers with zero- or low-bleed pneumatic controllers would likely provide the greatest opportunities for meaningful and cost-effective emission reductions. Given the current data limitations described in the report, no new regulatory emission reduction actions were proposed by BSEE or BOEM. Nevertheless, this remains an ongoing area of interest for the two bureaus.

## STUDY OBJECTIVES

BSEE is committed to searching for and adopting new and progressive methods for further enhancing safety, environmental protection, and the conservation of resources on the OCS. It is therefore incumbent upon the Bureau to explore possibilities that may exist for the increased capture of gas that would otherwise be vented and flared in offshore operations.

To support efforts for increasing the capture of intentionally vented and flared natural gas, BSEE enlisted the assistance of Argonne National Laboratory (“Argonne”) to research, analyze, and report on how much gas is released, how much could be captured and marketed (or used), and under what situations it would be cost-beneficial to society for offshore operations to apply available technology and capture gas. This activity is intended to support the advancement of knowledge about venting and flaring practices in offshore operations and foster improvements in the oversight and regulation of venting and flaring activities.

Argonne’s venting and flaring research for BSEE has yielded this report, which is organized in the following five parts:

1. Overview of current venting and flaring regulations in the U.S. and abroad;
2. Estimation of total volumes of intentionally vented and flared gas associated with oil and gas production on the OCS;
3. Description of current technologies to capture gas that would otherwise be intentionally vented or flared;
4. Results of a cost-benefit analysis of prospective venting and flaring regulations; and
5. Summary conclusions and recommendations.

The report’s appendices provide additional information that contrasts BSEE’s current venting and flaring regulations with those of other regulatory bodies and characterizes evaluated gas capture technologies.

# OVERVIEW OF CURRENT VENTING AND FLARING REGULATIONS

## ISSUE BACKGROUND AND REGULATORY CHALLENGES

During the production of oil and gas at an offshore facility (also referred to as a “complex” or “platform”), production from a well is sent to a separator, where it is divided into its base components of oil, gas, and water. The oil is processed to remove impurities and exported via a crude oil pipeline or a shuttle tanker to a refinery. The extracted gas is typically processed, compressed, and transported via pipeline for sale; or used on the production facility to generate electricity and power production equipment such as compressors. Though not a common practice in the Gulf of Mexico, in some cases, natural gas can be reinjected into the well to maintain reservoir pressure.<sup>2</sup>

In addition to the sale, use, or reinjection of natural gas, a portion of the gas is regularly lost through direct releases into the atmosphere. The release of this gas, via venting and flaring, is often necessary for a variety of operational reasons. For the purpose of this report, *flaring* refers to the controlled combustion of natural gas on a production facility, and *venting* is the controlled release of natural gas into the atmosphere without combustion.

The processes of venting and flaring can be sorted into two categories of activity: continuous and intermittent. The latter category of intermittent venting and flaring can be further divided into unplanned situations (for example, emergency situations and equipment failures) and planned situations (for example, platform startups, maintenance, and tests).<sup>3</sup> Intermittent venting and flaring may also take place when operators purge the water or hydrocarbon liquids collected in wellbores (well uploading) to maintain proper well function.<sup>4</sup> Production equipment may also emit gas to maintain proper internal pressure; and in some cases, the release of pressurized gas itself serves as a power source for a piece of equipment (particularly in remote areas or areas that are not linked to an electrical grid).<sup>5</sup> This “operational” venting may involve the continuous release of gas from pneumatic devices, such as valves that control gas flows, levels, temperatures, and pressures and that rely on pressurized gas for operation.<sup>6</sup>

---

<sup>2</sup> BSEE and BOEM Response to GAO Report GAO-11-34, *Reducing Methane Emissions from the Offshore Oil and Gas Industry in the Gulf of Mexico Outer Continental Shelf*, February 2015 (“BSEE/BOEM Reducing Methane Emissions”), page 6.

<sup>3</sup> World Bank, Global Gas Flaring Reduction Partnership (GGFR), *Guidance on Upstream Flaring and Venting Policy and Regulation*, March 2009 (“GGFR Guidance”), page 9.

<sup>4</sup> GAO, *Federal Oil and Gas Leases, Opportunities Exist to Capture Vented and Flared Natural Gas Which Would Increase Royalty Payments and Reduce Greenhouse Gases*, GAO-11-34, October 2010, page 5.

<sup>5</sup> GAO-11-34, page 5.

<sup>6</sup> GAO-11-34, page 5.

Though gas losses from venting and flaring were at one time thought to be *de minimis* in comparison to the overall volumes of natural gas recovered and processed, advances in data collection (i.e., new reporting regulations) and the use of new technologies (e.g., infrared cameras) have revealed losses much greater than originally thought.<sup>7</sup> As a result, since 2004, the GAO has been examining how to improve regulations and address instances of venting and flaring during natural gas production. GAO reports show the progression of U.S. regulations and form the backdrop for the actions of the BSEE and BLM in recent years.

The goals for regulating intentional instances of venting and flaring vary depending on when and how the activity takes place. The overall goal with respect to continuous events is to avoid venting and flaring through the capture and sale (or use) of this gas. The capture and sale of gas depends on the availability of sufficient gas production, the costs, and the existing infrastructure. In other words, if cost-effective to do so, operators of production platforms would be expected to invest in capturing gas rather than flaring or venting. In contrast, intermittent events are typically addressed through improved operational practices that minimize the numbers and durations of events resulting in venting and flaring volumes.<sup>8</sup>

Initially, GAO recommended regulatory changes that called for improved reporting and oversight, as well as exploration of the costs and benefits of requiring producers to flare rather than vent during standard operational procedures.<sup>9</sup> GAO also recommended the use of meters to measure the amounts of gas flared and vented and promoted programs that would help industry leaders identify and implement best practices for controlling natural gas emissions (in particular, the U.S. Environmental Protection Agency (EPA) Natural Gas STAR program).<sup>10</sup> The GAO further recommended examining market barriers that affect gas produced outside the United States, including any regulatory barriers to economically feasible infrastructure development.<sup>11</sup>

## INTERNATIONAL REGULATORY BEST PRACTICES

Among the leading international authorities on best practices for regulating venting and flaring are the World Bank and its Global Gas Flaring Reduction (GGFR) Partnership. In 2004, the GGFR conducted a survey of existing practices for regulating venting and flaring. While the survey yielded no international best practice or generally accepted theory about who should regulate flaring and venting, most surveyed countries used either prescriptive or performance-based regulation.<sup>12</sup> A prescriptive regulatory system uses specific and detailed regulations that give clear directions on regulatory processes and procedures, set expectations of operators, and

---

<sup>7</sup> GAO-11-34, pages 5-6.

<sup>8</sup> GGFR Guidance, page 9.

<sup>9</sup> GAO-04-809, page 7.

<sup>10</sup> GAO-04-809, page 20.

<sup>11</sup> *Id.*

<sup>12</sup> GGFR Global Overview, page 8.

provide incentives for compliance through strict enforcement.<sup>13</sup> In theory, this approach makes it relatively easy for regulators to set targets and determine whether operators are meeting requirements.<sup>14</sup> In practice, however, imposing detailed technical regulations is a challenging and complicated undertaking. In addition, monitoring compliance on each site could be impractical and costly.<sup>15</sup>

Consequently, most countries surveyed by GGFR opted for a more performance-based approach to flaring and venting reductions.<sup>16</sup> While this approach still requires strict enforcement, it places greater emphasis on consensus and cooperation between the industry and the regulator in setting objectives and targets for gas flaring and venting.<sup>17</sup> It is then the responsibility of the operator to define strategies for achieving these targets and provide evidence demonstrating compliance with the agreement.<sup>18</sup>

Irrespective of the approach adopted, GGFR recommended that regulators focus on two key areas: operational processes and regulatory procedures.<sup>19</sup>

**Operational Processes:** Since flaring and venting are important safety measures, the GGFR examined whether specific operational standards that ensured environmental health and safety were being met when operators flared and vented associated gas. While these practices were subject to a variety of conditions, issues addressed by operational standards and guidelines included:

- How gas is “burned,” “burn technologies and practices,” and where equipment and operating processes may be specified to ensure burning of “clean” gas and efficient combustion; and
- Timing of instances, where the maximum duration of continuous venting and flaring may be limited.<sup>20</sup>

**Regulatory Procedures:** In general, regulatory procedures focus on the approval of applications to flare and vent. They also focus on measuring and reporting events where gas is flared and vented.<sup>21</sup> Regulatory procedures encompass the following areas:

---

<sup>13</sup> Id.

<sup>14</sup> Id.

<sup>15</sup> Id.

<sup>16</sup> Id.

<sup>17</sup> Id.

<sup>18</sup> Id.

<sup>19</sup> GGFR Global Overview, page 9.

<sup>20</sup> GGFR Global Overview, pages 9-10.

<sup>21</sup> GGFR Global Overview, page 11 (noting the value of having regulatory procedures made public to achieve openness and transparency goals).

- Approval of Venting and Flaring: Since many countries allowed flaring and venting for safety or unavoidable technical reasons (or during emergencies), the GGFR concluded that permissible grounds for venting and flaring were often vague. Only a few countries had clearly defined circumstances and events that would allow permissible flaring and venting without prior approval.<sup>22</sup> The GGFR recommended that these circumstances be clearly defined in regulation.<sup>23</sup>

Where preapproval was sought, the GGFR observed that application and approval procedures could take place in a number of different ways (as part of an overall field development approval or as a separate permit per vent or flare event). Before approving venting and flaring volumes, regulatory agencies often required operators to provide evidence about the likely impact flaring and venting would have on the environment. This evidence was acquired through an environmental impact assessment (EIA) that had to be submitted as part of the vent or flare permit or field development application process.<sup>24</sup>

As part of the approval procedure, the GGFR noted that regulators, before issuing authorizations, increased their examination of the economics involved, which required operators to prove it was uneconomical for them to avoid venting or flaring.<sup>25</sup> Some jurisdictions made it mandatory that operators prove they had investigated all reasonable alternatives to flaring and venting, including the use and sale of captured gas in downstream energy markets.<sup>26</sup> One trend was that regulators were adopting an “incremental” approach, in which they were allowing operators to flare or vent only if they could prove the incremental benefits of not venting or flaring were lower than the incremental costs.<sup>27</sup> Under this approach, flaring and venting of gas was considered a negative externality (unwanted consequence) of oil production, and the costs of that externality had to be fully included in assessing the net benefit of oil production in a field.<sup>28</sup>

- Measuring and Reporting: The GGFR stressed the importance of collecting accurate information on venting and flaring volumes. Many regulators surveyed required operators to report venting and flaring volumes accurately and allowed operators to decide whether to install meters or provide estimates based on approved engineering calculations and procedures. Some regulators required meter installations if established volume thresholds

---

<sup>22</sup> GGFR Global Overview, pages 11-12 (noting the decision was often left to the discretion of operators with reference to good oil field engineering practices and utilization principles).

<sup>23</sup> *Id.*

<sup>24</sup> GGFR Global Overview, pages 12-13.

<sup>25</sup> GGFR Global Overview, page 13.

<sup>26</sup> *Id.*

<sup>27</sup> *Id.*

<sup>28</sup> GGFR Global Overview, page 14.

were exceeded.<sup>29</sup> In many countries, operators were required to maintain flaring and venting registers that were subject to audit and to report data to the regulatory authority on a regular basis.<sup>30</sup>

According to the GGFR’s survey, most regulators acknowledged the ineffectiveness of operating processes and regulatory procedures without adequate monitoring and enforcement powers in cases of noncompliance.<sup>31</sup> Because technical and financial restrictions limit the monitoring of all flaring and venting sites, the GGFR noted that site inspections form an integral part of more advanced—and more aggressive—regulatory systems.<sup>32</sup> The GGFR considered the potential costs and requirements of qualified personnel to carry out such site visits. They noted that monitoring has been applied mostly in industrial-country jurisdictions, where regulators have developed methods and criteria that preselect installation sites most likely to require close regulatory scrutiny.<sup>33</sup> Where violations were found, many regulators imposed sanctions (enforcement actions) on operators. These took the forms of penalties, fines, or withdrawal of a production or operation license.<sup>34</sup>

In response to its survey of existing practices, the GGFR expressed that government commitment to reducing venting and flaring, through a strong regulatory system, was critical.<sup>35</sup> Industry consultation was also seen as important for ensuring that flaring and venting targets were feasible and for encouraging operators to utilize gas economically.<sup>36</sup> The GGFR also stated that accurate measurement and reporting of flared volumes was necessary if enforcement was to be effective and that access to reliable and consistent data was critical for identifying intervention needs, trends, and increases.<sup>37</sup>

In order to support these recommendations, the GGFR advised that successful systems should have the following characteristics:

- Legislation should be clear, comprehensive, and unambiguous in its treatment of gas.<sup>38</sup>
- Incentives and penalties should create a situation where the economically preferred method of handling gas production is through utilization.<sup>39</sup> Penalties could be assessed

---

<sup>29</sup> *Id.*

<sup>30</sup> *Id.*

<sup>31</sup> GGFR Global Overview, page 17.

<sup>32</sup> *Id.*

<sup>33</sup> *Id.*

<sup>34</sup> GGFR Global Overview, page 18.

<sup>35</sup> GGFR, *International Practices in Policy and Regulation of Flaring and Venting in Upstream Operations – Lessons from International Experience*, GGFR SCM Workshop, Dec. 2011 (“GGFR SCM Workshop”).

<sup>36</sup> *Id.*

<sup>37</sup> *Id.* (noting data could be made public as well if appropriate).

<sup>38</sup> GGFR Guidance, page 1.



for gas that could have been utilized or was flared or vented without approval. These penalties should be high enough to make investment attractive, but not so high as to force the closing of operations.<sup>40</sup>

- Effective monitoring and enforcement should encourage operators to consider every option for gas utilization and sale.<sup>41</sup>
- A strong measurement and reporting system can enable effective monitoring of operators’ compliance with approved venting and flaring levels. This system can identify underperforming production platforms (e.g., by comparing the performance of similar platform types), identify cases warranting a site inspection, and monitor progress in venting and flaring reduction within a jurisdiction. Reports on all events should be required, regardless of the size of the event, and should distinguish between continuous and intermittent events. Daily logs can be maintained, reported at least on a monthly basis, and retained for “a few” years.<sup>42</sup> Ad-hoc site inspections can then be used to make sure records are being kept, ensure appropriate gas measuring equipment is installed, and check on methodologies used to estimate venting and flaring volumes.<sup>43</sup>
- Through stakeholder consultations, comprehensive and methodical approaches can be developed to address venting and flaring. This can be done by creating an environment that encourages gas utilization investments, establishing a realistic schedule of required action for flare and vent reductions, coordinating operators’ investment programs, and closely monitoring programs to ensure they are implemented on time.<sup>44</sup>
- Any approach that requires prior approval to flare or vent for each installation may be practical when there is a small number of installations, but may be impractical when the number is much larger. Where large numbers of installations are present, operators should be required to invest in gas utilization projects where the net present value of the project is above an industry-wide threshold established by the regulator. Where there are a manageable number of installations, the regulator may request the operator seek approval for venting or flaring activity if the duration of an event exceeds a certain threshold.
- Regulatory systems using an economic framework can be regularly reviewed and updated (for example, every 12 months), and the framework should specify baselines for each economic criterion, including rules for the net present value (NPV) calculation, discount rates, operating costs, standard rates to be used for estimating capital expenditures, price

---

<sup>39</sup> *Id.*

<sup>40</sup> GGFR Guidance, page 7.

<sup>41</sup> *Id.*

<sup>42</sup> If the emission of greenhouse gases is a concern, this reporting system should be integrated into whatever existing reporting system for the upstream hydrocarbon sector is used. GGFR Guidance, page 13.

<sup>43</sup> *Id.* (noting onsite inspections can be challenging since vented gas is not visible to the naked eye).

<sup>44</sup> GGFR Guidance, pages 1-2.



forecasts for commodities which can be produced from associated gas, inflation assumptions, and the gas processing and pipeline tariffs.

- Finally, the GGFR recommends that the annual reporting of flaring and venting volumes should provide a clear measure of progress in flaring and venting reduction and should encourage and incentivize continuous improvement.

## CURRENT OFFSHORE REGULATIONS AND GUIDANCE IN THE U.S.<sup>45</sup>

According to current regulations and guidance governing venting and flaring on the U.S. Continental Shelf, an operator must request and receive approval from the BSEE Regional Supervisor to flare or vent natural gas, except in specific situations which are outlined in the Code of Federal Regulations (CFR) and in BSEE directives. These situations include operational testing, emergencies, and equipment failures. They also allow venting and flaring where the gas is lease-use gas or is necessary to burn additional waste products.<sup>46</sup> In these situations, duration and volumes are managed and limited by regulation and by the filing of operations plans. Even with these allowances, however, shorter time limits or additional volume restrictions may be imposed to prevent air quality degradation or the loss of reserves.<sup>47</sup>

Facilities processing more than an average of 2,000 barrels of oil per day (bopd) must install flare or vent meters, which must measure within 5% accuracy and be used and maintained for the life of the facility.<sup>48</sup> Operators are required to report amounts of gas vented or flared and maintain records onsite detailing incidents of flaring and venting, including their amounts and durations.<sup>49</sup> If meters are not required at a facility, operators may report gas flared or vented on a lease or unit basis.<sup>50</sup> As of now, requests to flare or vent gas are denied unless absolutely necessary. Reasons qualifying as “absolutely necessary” include national interest, safety, and maximizing oil recovery. Violations could result in civil or criminal penalties.<sup>51</sup>

BSEE has stated that its regulatory approach rests on balancing the need to reduce emissions with the need to allow venting and flaring when required for safety and to prevent danger to life and property. In 2012, BSEE issued additional guidance on flaring and venting metering and the processing of requests for approval to flare or vent. Notice to Lessees (NTL) No. 2012 N-03 addressed meter installations and accuracy, and NTL 2012-N04 provided guidance for requesting approval to flare or vent natural gas and for the discretionary authority of BSEE to approve such

---

<sup>45</sup> The complete text of the regulations and expanded summaries of BSEE guidance is included as a separate appendix.

<sup>46</sup> 30 CFR §250.1160. Lease-use gas is produced national gas which is used on or for the benefit of lease operations such as gas used to operate production facilities.

<sup>47</sup> 30 CFR §250.1160, 1161.

<sup>48</sup> 30 CFR §250.1163.

<sup>49</sup> *Id.*

<sup>50</sup> *Id.*

<sup>51</sup> 30 CFR §250.1160.

requests. In particular, NTL 2012-N04 represented a stricter policy and improved BSEE’s conservation enforcement. No flaring or venting without permission would be allowed except in limited circumstances permitted on a case-by-case basis at BSEE’s discretion. These limited circumstances include:

- When the BSEE Director determines flaring or venting is in the national interest, such as when a major hurricane causes widespread and catastrophic gas infrastructure damage, leading to significant declines in national oil production and rapidly escalating oil prices;
- When the operator demonstrates to the Regional Supervisor’s satisfaction that production from the well completion would likely be permanently lost if the well shut in; or
- When the operator demonstrates to the Regional Supervisor’s satisfaction that short-term flaring or venting would likely yield a smaller volume of lost natural gas than if the facility were shut in and restarted later (with flaring and venting necessary to restart the facility).

When considering requests to approve flaring or venting, BSEE does not consider the avoidance of lost revenue to be a justifiable reason. Any requests for venting and flaring based on the need to avoid the installation of gas transportation or conditioning equipment will not be approved unless the cost of installing the equipment makes the entire project, including oil produced from the facility, uneconomical.<sup>52</sup>

In 2015, BSEE issued further guidance to govern procedures for use by Resource Conservation Section (RCS) personnel in processing flaring and venting requests; namely, the Bureau Interim Directive (BID)-2015-G070, *Standard Operating Procedures for Processing and Issuing Decisions Regarding Flaring, Venting, and Burning Requests; Requests to Produce Within 500-ft of Lease/Unit Boundary; Gas Cap Production Requests; and Downhole Commingling Requests*. The BID notes that requests to flare or vent beyond allowed thresholds should be denied unless an exception outlined in NTL No. 2012-N04 applies. The BID also clarified the situations in which those NTL exceptions would be granted. For exception #1 to apply—national interest—direction must be given from top BSEE management. For exception #2 to apply—permanent loss of production—RCS personnel will 1) examine the well-completion history to determine if there is “solid evidence” of increased problems bringing the completion back online after a shut in; 2) evaluate the most recent well test data if the operator is claiming flow assurance concerns; 3) discuss historical flow assurance strategies (in particular, looking at the last three times the wells were shut in); and 4) determine if a minimum flow rate exists at which the well completion can be produced. For exception #3 (less lost natural gas) to apply, RCS personnel will evaluate the historical data (again focusing on the last three instances) and the well-test data to confirm that the operator’s requested rates are reasonable and to confirm that high-gas/oil-ratio (GOR) wells (wells with a GOR greater than 1500 scf/barrel) are not being produced.

---

<sup>52</sup> BSEE, Conservation Enforcement of Oil and Gas Resources on the Outer Continental Shelf, Bureau of Safety and Environmental Enforcement, Sept. 28, 2012 (“BSEE Conservation Enforcement”).

The guidance notes that initial flaring and venting approvals should not exceed the time estimated to reach the first milestone. Before an extension to the flaring and venting approval can be granted, a recapitulation report listing progress since the last flaring and venting approval or extension should be supplied by the operator. If significant progress has not been made, additional flaring and venting usually will not be approved. Extensions should not be made if volumes or conditions change such that the total cumulative volume flared or vented would exceed the restart flare or vent volume.

BSEE notes that approval of requests has decreased in number in recent years, due in part to the sizeable flaring and venting volumes that can occur when pieces of equipment on deep-water facilities break down.

BSEE also conducted an internal review of regulations following the Deepwater Horizon catastrophe in April 2010, *An Internal Review of BSEE Regulations Thirty Months After Macondo, Oct. 2012* (“BSEE Internal Review”), which noted significant areas for improvement in regulatory oversight with regard to flaring and venting.

In 2015, BSEE also issued additional guidance on inspection procedures and guidance pertaining to the flaring or venting of low-volume flash gas from storage or other low-pressure production vessels. This guidance also provides associated inspection procedures.<sup>53</sup> Inspection procedures were detailed to verify compliance with CFR Part 250, Sections 1160 and 1163, and directed inspectors to verify operator calculations of flared and vented gas volumes, proper recording of volumes, and maintenance of records. If inspectors observed that gas volumes exceeded 50 Mcf/D without verified approval, or if there appeared to be “suspect” operator records, inspectors were required to issue a report.<sup>54</sup> ONRR was then notified if operators flared or vented “avoidably lost” gas.<sup>55</sup> BSEE required Office of Production and Development (OPD) personnel to witness 10% of all oil sales meter provings<sup>56</sup> and 5% of gas meter provings and to conduct site security inspections for regulatory compliance and protection of federal production.<sup>57</sup> BSEE also noted that gas flaring inspections would be conducted by inspection personnel to ensure operator adherence to gas flaring regulations and any conditions of flaring approval.<sup>58</sup> Finally, BSEE provided standard operating procedures for measurement inspections.<sup>59</sup>

---

<sup>53</sup> BID-2015-G069, *Guidance and Inspection Procedures RE Documentation Requirements for Flaring or Venting of Low-Volume Flash Gas*, Sept. 1, 2015.

<sup>54</sup> *Id.*

<sup>55</sup> *Id.*

<sup>56</sup> Meter “provings” test meters for accuracy.

<sup>57</sup> BID-2015-P015, *Procedures Regarding Production Management, Site Security, and Gas Flaring Inspections*, Sept. 8, 2015.

<sup>58</sup> *Id.*

<sup>59</sup> BID2015-G096, *Standard Operating Procedures for Performing Measurement Inspections, MIU, MAES*, Sept. 15, 2015.

The following section provides an overview of offshore oil and gas projection trends in the U.S. and a forecast of venting and flaring volumes.

## ESTIMATION OF VENTING AND FLARING VOLUMES

### PRIMARY DATA SOURCES

In order to evaluate the costs and benefits of potential increases in the capture of vented and flared gas, it is important to acquire data on both the current situation and estimated future volumes under a range of plausible scenarios. As a first step, the research team estimated as accurately as possible the total volumes of gas being vented and flared by production facilities on the OCS and provided a breakdown of how much gas is vented and flared under different situations.

The following data sources were considered in estimating historical venting and flaring volumes associated with oil and gas production on the OCS:

- Technical Information Management System (TIMS);
- Gulfwide Offshore Activity Database System (GOADS); and
- Oil and Gas Operations Reports Part A (OGOR-A) and Part B (OGOR-B).

The TIMS and GOADS databases are maintained by BOEM, while the Office of Natural Resources Revenue (ONRR) is responsible for compiling the OGOR databases. The following factors were considered when deciding which databases would be used in this venting and flaring research study:

- For each oil and gas production facility on the OCS, TIMS contains specific information about the complex (e.g., structure type, location, water depth, associated wells) and installed production equipment (e.g., compressor, flare boom).<sup>60</sup>
- For each OCS oil and gas production facility in the Gulf of Mexico, GOADS contains monthly activity data and estimated volumes of criteria pollutant and greenhouse gas emissions.<sup>61</sup> At the time of this study, GOADS-2011 is the most recent version of the database.
- All federal leaseholders are required to submit monthly OGOR reports to the ONRR financial accounting system. OGOR-A specifies oil and gas production volumes for each well on a lease agreement.<sup>62</sup> OGOR-B accounts for the total disposition of lease-agreement production for each product (oil and gas) produced on OGOR-A.<sup>63</sup> These

---

<sup>60</sup> TIMS data is publicly available on BOEM’s website:  
[https://www.data.boem.gov/homepg/data\\_center/platform/platform.asp](https://www.data.boem.gov/homepg/data_center/platform/platform.asp).

<sup>61</sup> BOEM, *Year 2011 Gulfwide Emission Inventory Study*, November 2014, page 13.

<sup>62</sup> Agreements may be established to pool federal oil and gas leases which cannot be independently developed.

<sup>63</sup> ONRR, *Minerals Production Reporter Handbook*, ONRR Release 2.0, September 2014.

monthly dispositions include the amounts of gas used, sold, vented, or flared.<sup>64</sup> OGOR data for calendar year 2015 was available in the summer of 2016 for use in this study.

- As noted in the 2015 BSEE/BOEM methane study report, “GOADS emissions data give more detailed coverage of non-marketed natural gas volumes, but for production data by facility, OGOR is needed. Also, the GOADS inventory is less useful for trend analysis since it is only updated once every three years. OGOR data, in contrast, captures all production by disposition category on a monthly basis. The OGOR flaring and venting data reveal valuable trends in venting and flaring volumes over time.”<sup>65</sup>

Considering the accuracy, timeliness, and suitability of available data, Argonne decide on the following approach for preparing an inventory of historical venting and flaring volumes associated with oil and gas production on the OCS:

1. Utilize OGOR-A and OGOR-B datasets containing reported monthly production and venting and flaring volumes by lease agreement from January 2011 through December 2015;
2. Utilize TIMS for information on all production facilities;
3. Create the Argonne Vent and Flare database (AVF-DB) that links OGOR with TIMS to produce an inventory of monthly production, vent, and flare volumes by facility; and
4. Validate the accuracy of information in the AVF-DB.

Through the linking of datasets, as illustrated in Figure 1, oil and gas production volumes from OGOR-A and venting and flaring volumes from OGOR-B were linked according to respective production complexes to create an initial AVF-DB.<sup>66</sup>

## TRENDS IN OIL AND GAS PRODUCTION AND ASSOCIATED VENTING AND FLARING VOLUMES

An analysis of historical OGOR data shows that, while offshore natural gas production in the GOM is in stark decline (Figure 2), offshore oil production is increasing with an upsurge in deep-water production (Figure 3).

---

<sup>64</sup> OGOR data is publicly available on BOEM’s website:

[https://www.data.boem.gov/homepg/data\\_center/production/production.asp](https://www.data.boem.gov/homepg/data_center/production/production.asp).

<sup>65</sup> BSEE/BOEM Reducing Methane Emissions, page 14.

<sup>66</sup> A review of the resulting database identified that 0.01% of the total OGOR-B reported flare volume for 2015 was not assigned to a complex. To reconcile this difference, a new record, with Complex\_ID\_Num of 99999, was added to the AVF-DB.

## BSEE Venting and Flaring Research Study

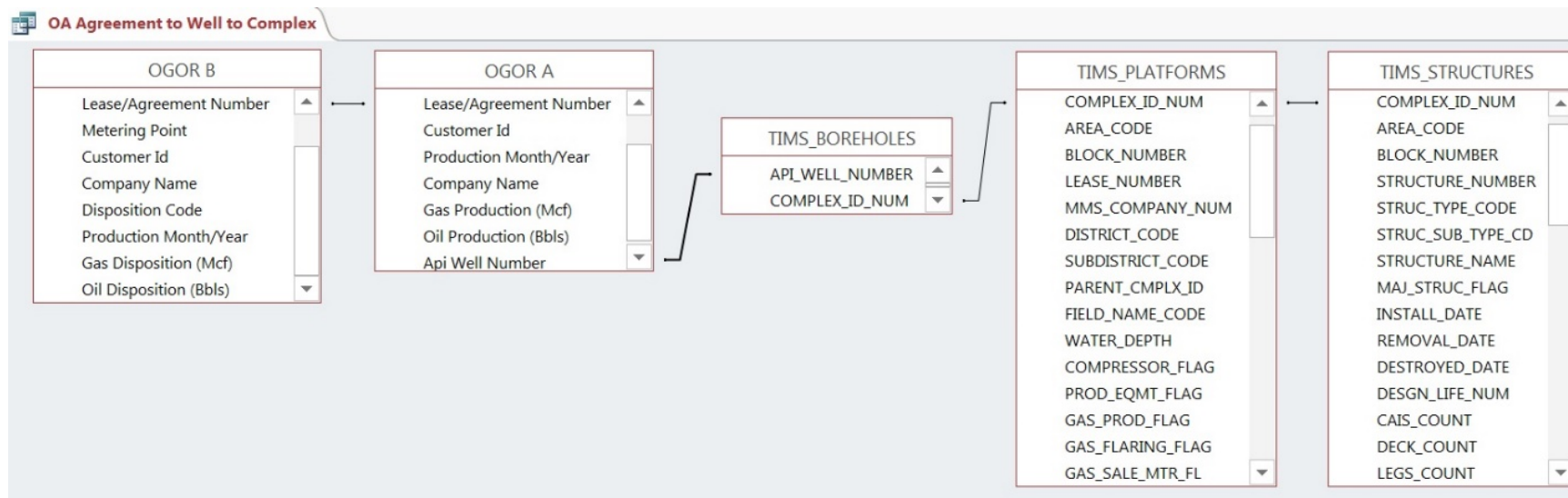

Figure 1: Illustration of Link Between OGOR and TIMS Data Tables to Create Initial AVF-DB.

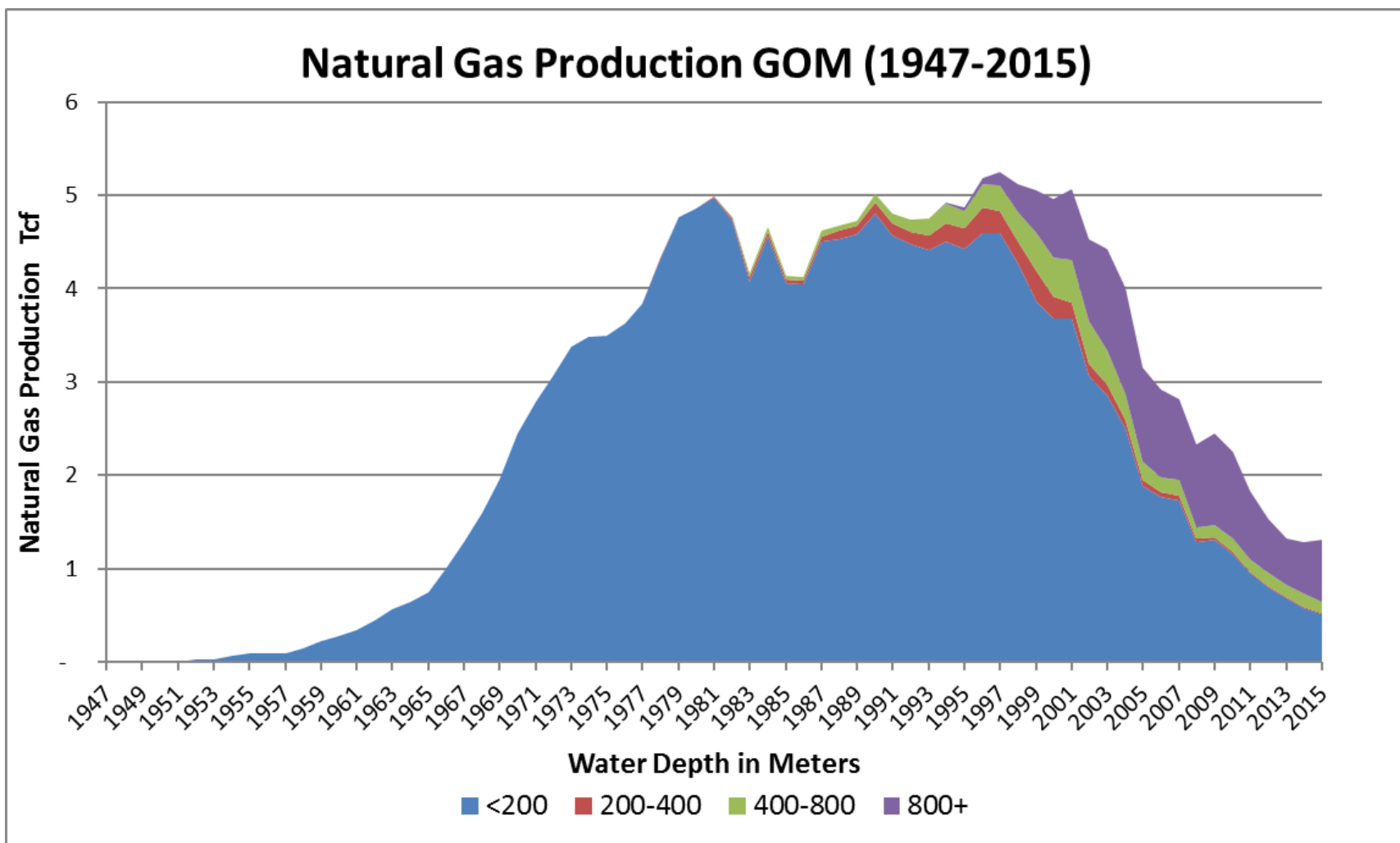

Figure 2: Natural Gas Production in the Gulf of Mexico.



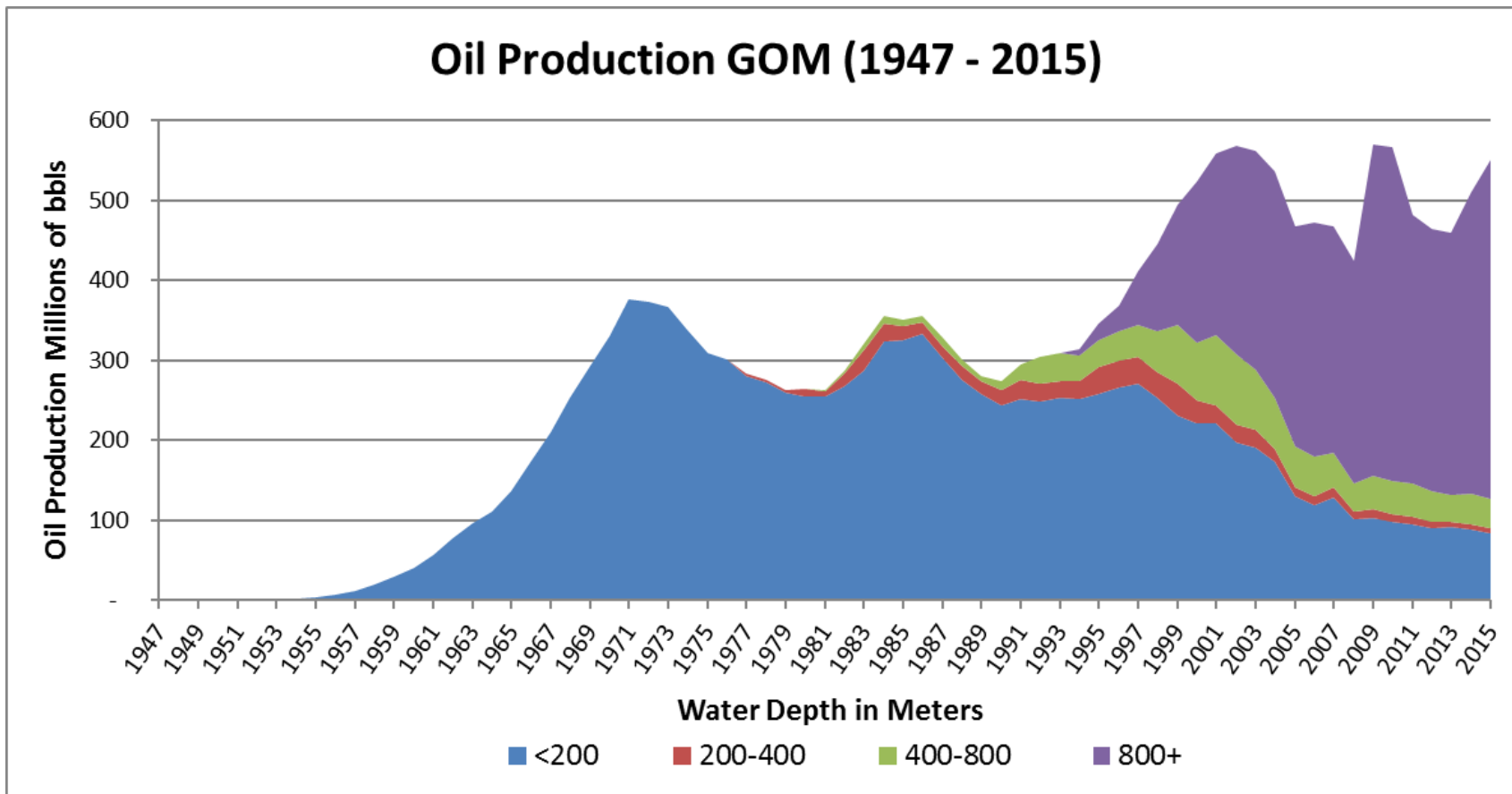

Figure 3: Oil Production in the Gulf of Mexico.

Since September 15, 2010, lease holders have been required to specify venting and flaring volumes separately in OGOR-B reports with disposition code 21 for flared oil-well gas, 22 for flared gas-well gas, 61 for vented oil-well gas, and 62 for vented gas-well gas. Natural gas production is typically reported in thousands of cubic feet (Mcf). Annual venting and flaring volumes associated with oil and gas production on the OCS are reported in Table 1.

**Table 1: Annual Venting and Flaring Volumes by Disposition as Reported in OGOR-B for OCS.**

Disposition			Gas (MMcf)				
Volume	Code	Source	2011	2012	2013	2014	2015
Flared	21	Oil-Well	5,801	8,203	5,724	5,939	6,663
	22	Gas-Well	1,393	1,074	710	881	593
	Total		7,194	9,277	6,434	6,821	7,256
Vented	21	Oil-Well	2,252	1,964	2,394	2,857	2,484
	22	Gas-Well	1,967	1,651	1,907	1,811	1,337
	Total		4,219	3,615	4,301	4,667	3,820

The 2015 BSEE/BOEM study on reducing methane emissions observed that “while natural gas production has declined, ...vented and flared gas volumes *as a percentage of produced natural gas* are increasing” and noted that additional investigation is needed to determine why.<sup>67</sup>

The World Bank GGFR reports that, while the U.S. is one of the top flaring countries (Figure 4), the national flaring intensity, defined as cubic meters of gas flared per barrel of oil produced, is comparatively low (Figure 5).<sup>68</sup>

<sup>67</sup> BSEE/BOEM Reducing Methane Emissions, page 15.

<sup>68</sup> <http://www.worldbank.org/en/programs/gasflaringreduction#7>

## BSEE Venting and Flaring Research Study

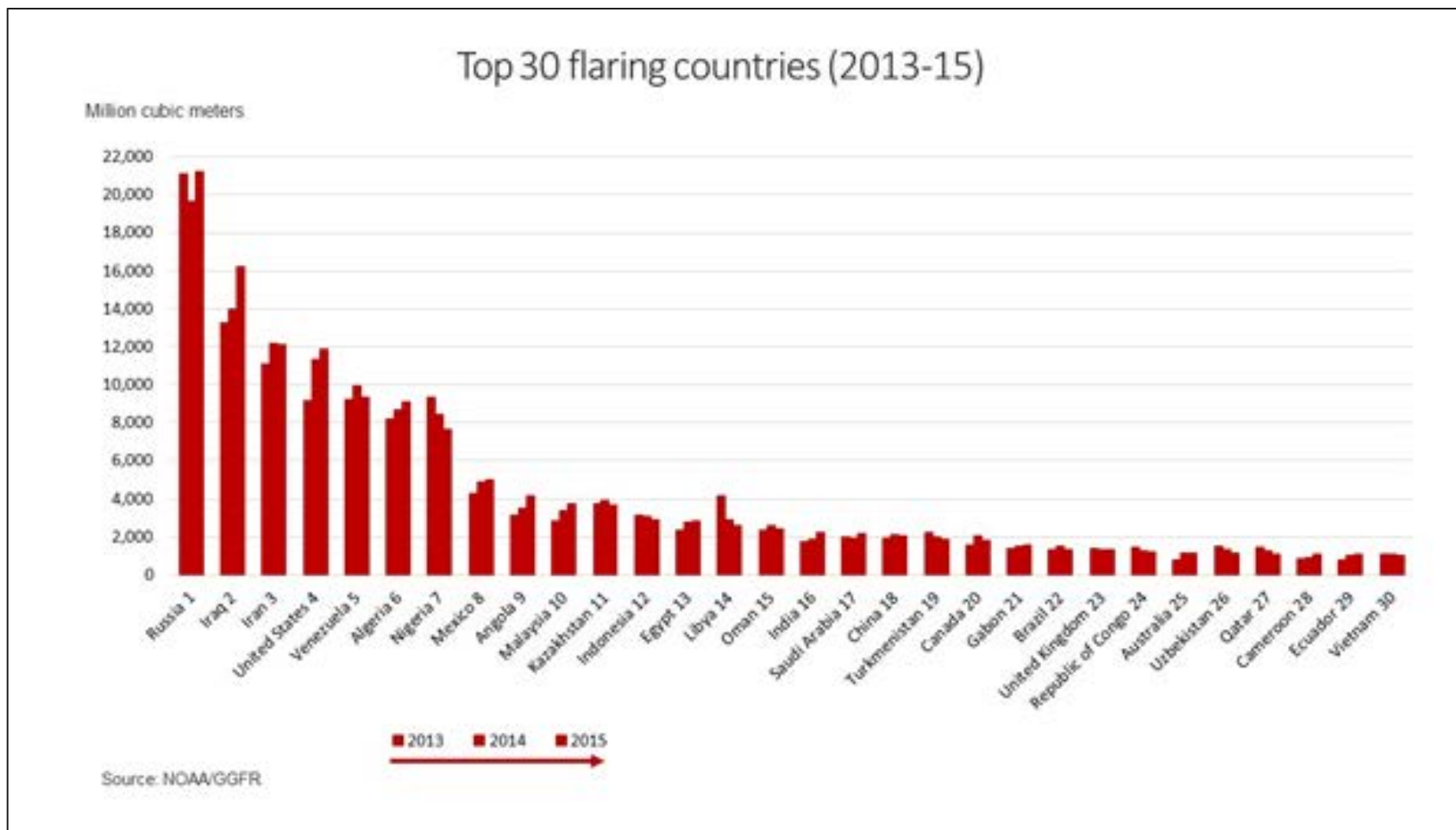

Figure 4: Top 30 Flaring Countries.

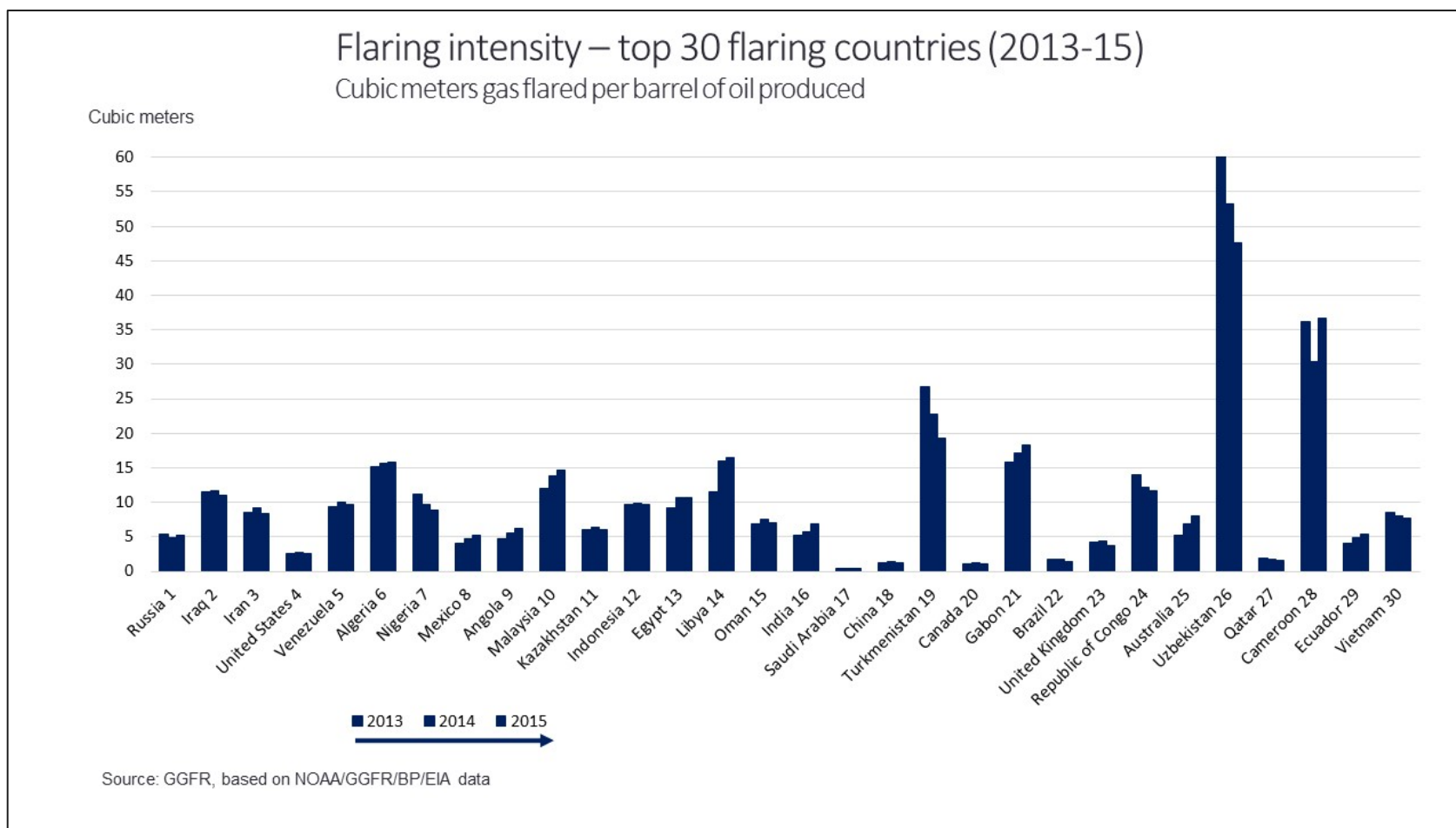

Figure 5: Flaring Intensity of Top 30 Flaring Countries.

## ANALYSIS OF VENTING AND FLARING VOLUMES BY FACILITY TYPE

Platforms in use on the OCS today range from a simple vertical caisson supporting a single well in shallow water (a “Single Well” structure) to a variety of floating structures that typically support production from numerous wells in very deep waters. Common types of platforms in use on the OCS are illustrated in Figure 6 and Figure 7. In this report, “Fixed Leg” structures include fixed platforms and compliant towers, while the other structures identified in Figure 6 and Figure 7 are referred to as “Floating” structures.

AVF-DB data for calendar years 2011 through 2015 was used to compute the values displayed in Table 2 for flaring and venting volumes, by structure type, as a percentage of gas production. These values point to floating structures being a primary contributor to flaring, while single-well and fixed-leg structures are primary contributors to venting.

**Table 2: Estimated Venting and Flaring Volumes as a Percent of Gas Production by Structure Type.**

Structure Type	Volume as % of Gas Production		
	Flare	Vent	Total Gas Lost
Single Well	0.03%	0.44%	0.47%
Fixed Leg	0.11%	0.34%	0.44%
Floating	1.18%	0.08%	1.26%

Another observation is that a substantial share of annual venting and flaring volume is attributed to monthly spikes. From 2011 through 2015, approximately 50% of total flaring volumes and 40% of vent volumes are from monthly spikes of twice the median value; while roughly 30% of flare and 20% of vent volumes are from spikes of four times the median.<sup>69</sup>

To identify instances of monthly spikes for further investigation, a worksheet was prepared containing a list of all operating production facilities during the 60-month period from January 2011 through December 2015, along with the associated monthly flaring volumes. A similar list with vent volumes was also prepared. These lists were ordered with higher-emitting facilities at the top. To draw attention to monthly spikes, cells containing monthly values greater than or equal to 1% of the total OCS-wide annual flared volume in 2015 are highlighted in red. Similarly, cells containing monthly values greater than 0.5% of the 2015 OCS-wide annual total are highlighted in yellow, and values greater than 0.1% in green.

Figure 7 provides a heat-map representation of flare volumes by facility. When viewing this figure note that red cells indicate instances where 1% of the annual total flaring volume for the OCS was produced in a single month by a single facility. Yellow cells indicate 0.5% of the annual total flaring volume for the OCS was produced in a single month by a single facility, and green cells 0.1% of the total. The arrows on Figure 8 point to cases of high monthly flaring volumes during periods of facility startup.

<sup>69</sup> Monthly venting and flaring volumes reported by lease in OGOR-B were linked to specific complexes in TIMS using the common API well number field (Figure 1). The median monthly flaring volume for a complex was then computed by sorting the list of associated monthly flaring volumes from January 2011 through December 2015 and selecting the middle number of the sorted list. For the sake of this report, the term “monthly spike” for flaring refers to cases where a complex has a monthly flaring volume that is at least twice its median flaring value.

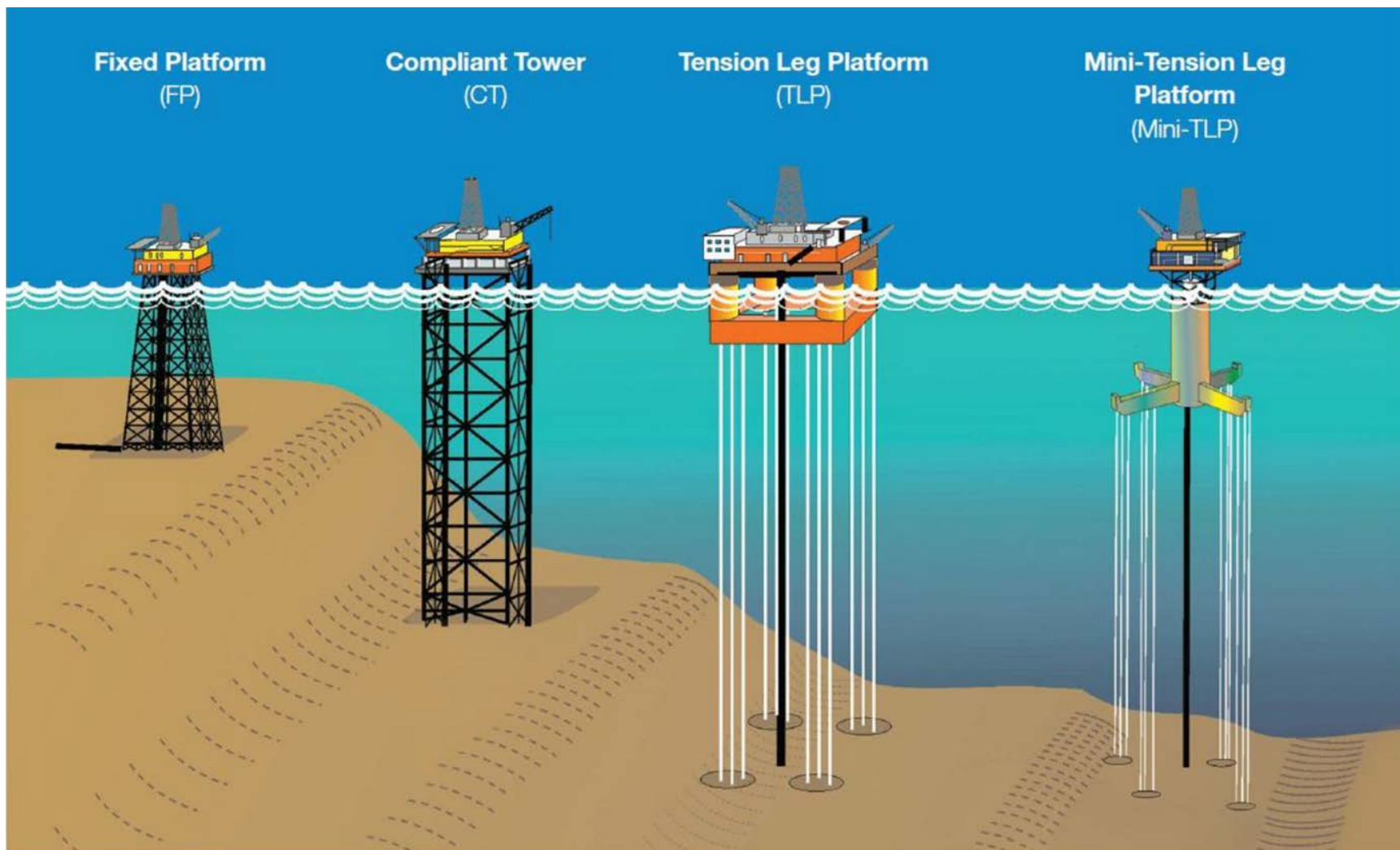

Image courtesy of The Bureau of Ocean Energy Management (BOEM)

Figure 6: Typical Types of Platforms in Use on the OCS (1 of 2).



BSEE Venting and Flaring Research Study

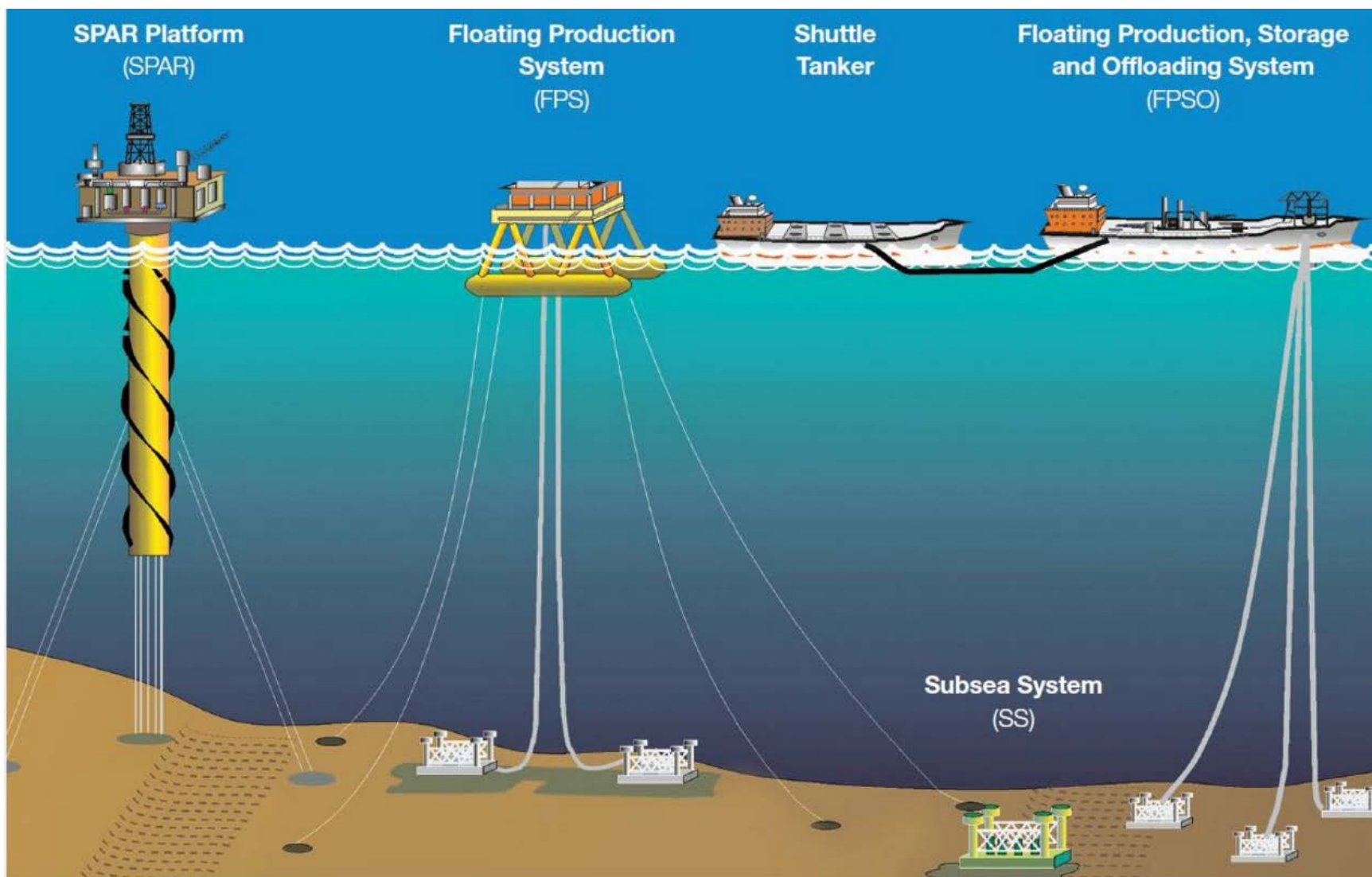

Image courtesy of The Bureau of Ocean Energy Management (BOEM)

Figure 7: Typical Types of Platforms in Use on the OCS (2 of 2).





Figure 8: Monthly Flaring Volumes by Facility on the OCS during 2011–2015.

## COMPARING MONTHLY SPIKES IN VENTING AND FLARING VOLUMES WITH REQUESTS APPROVED BY BSEE

As noted in CFR 240.1160, when equipment fails to work properly (for example, during equipment maintenance and repair or when system pressures must be relieved), facility operators must request and receive Regional Supervisor approval to vent or flare in excess of 48 continuous hours for oil-well gas, 2 continuous hours for gas-well gas, or 144 cumulative hours during a calendar month.

Given that 144 cumulative hours is 20% of a 30-day calendar month, Argonne evaluated whether any facilities reported monthly venting or flaring volumes that exceeded 20% of their maximum monthly gas production in 2015. **Forty-three (43) facilities had at least one month of reported vent volume greater than or equal to 20% of the individual facility’s maximum monthly gas production in 2015. The 234 months in which these facilities reported vent volumes that appear to be in exceedance regulatory limits accounted for 14.4% of the total annual venting volume from oil and gas production on the OCS.**

Argonne contacted the BSEE-GOM Regional Supervisor to share information on the identified monthly spikes in venting and flaring volumes and inquire whether operators requested approval to exceed in these months. The office of the Regional Supervisor shared information on past authorizations and provided helpful insights into the process for reviewing requests.

The numbers and volumes of authorized events for exceeding flaring limits in the GOM are provided in Figure 9 and Figure 10. There has been a substantial reduction in the number of authorized flaring events since 2012. The large increase in the amount of authorized flaring volumes is attributed to platform startups for deep-water floating structures (for which fixes to upset conditions can take longer than the allowed flare times).

The numbers and volumes of authorized events for exceeding venting limits in the GOM are provided in Figure 11 and Figure 12. There has been a large reduction in the number of authorized venting events, and the volume of authorized venting is low. The office of the BSEE-GOM Regional Supervisor noted that the larger vented volumes identified in Argonne’s analysis likely come from older facilities operating in shallow water, many of which do not have flares.

Argonne estimates, **in 2015, platform startups for deep-water floating structures accounted for roughly 15% of the total annual flaring volume on the OCS and an additional 20% of the annual total resulted from monthly spikes associated with compressor outage, pipeline maintenance, and well-unloading.**

Currently, there is no regular BSEE review of monthly venting and flaring volumes. BSEE inspectors see the daily venting and flaring reports on their facility visits, but do not request that operators forward a copy of their daily venting and flaring records for review at BSEE headquarters or the regional office. **Moving forward, BSEE is encouraged to review monthly venting and flaring volumes in OGOR-B reports to identify irregularities requiring further investigation, correction of data entry errors, or enforcement.**

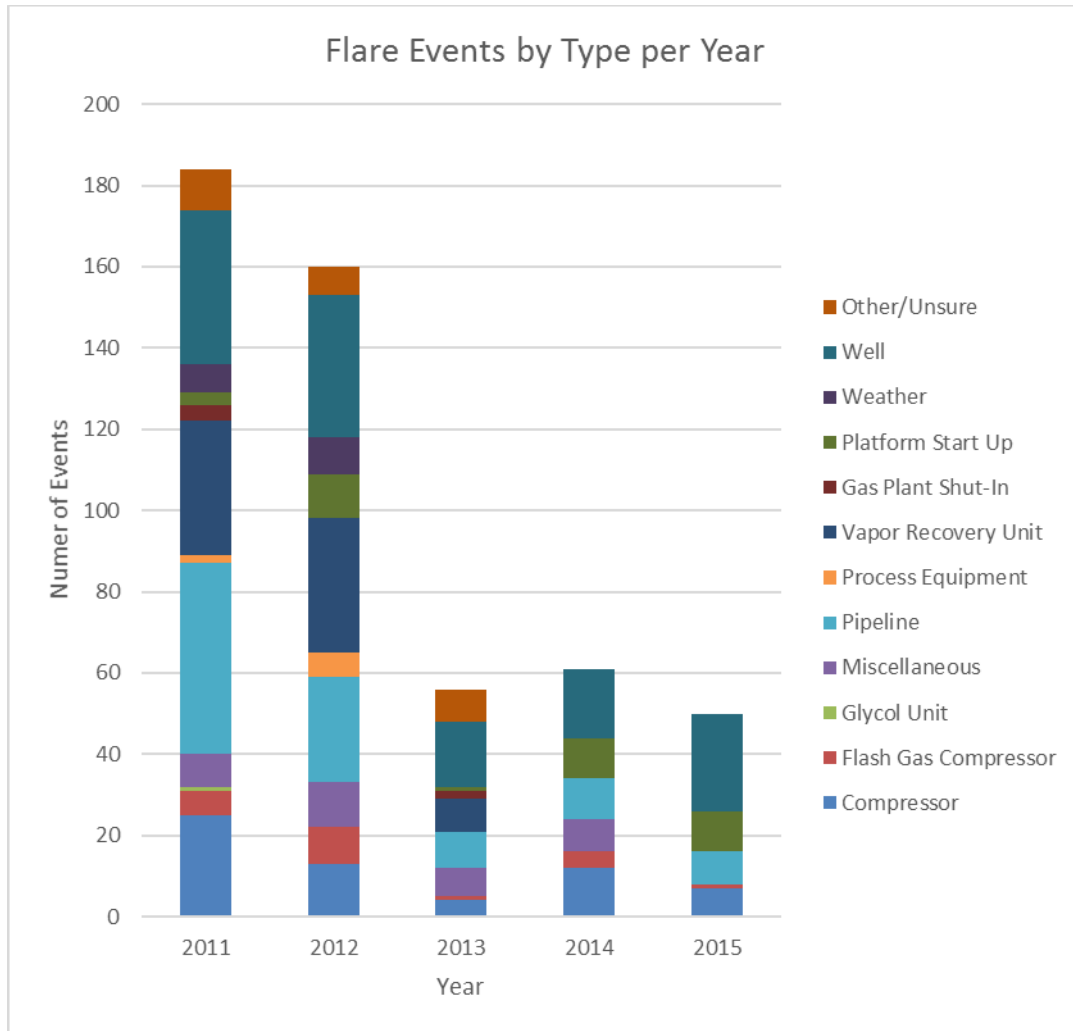

Figure 9: Number of Approved Events to Exceed Flaring Limit.

## BSEE Venting and Flaring Research Study

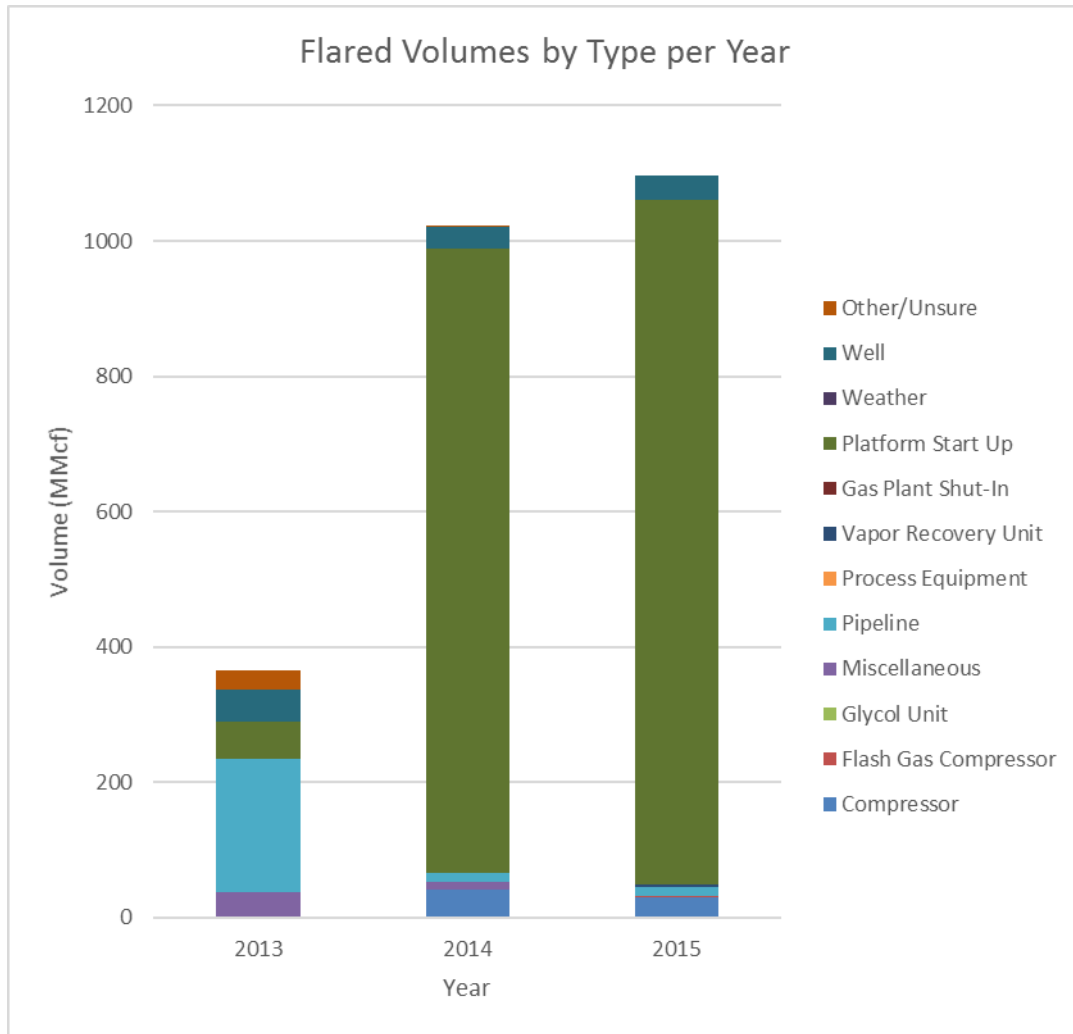

Figure 10: Volume Flared for Approved Events by Type.

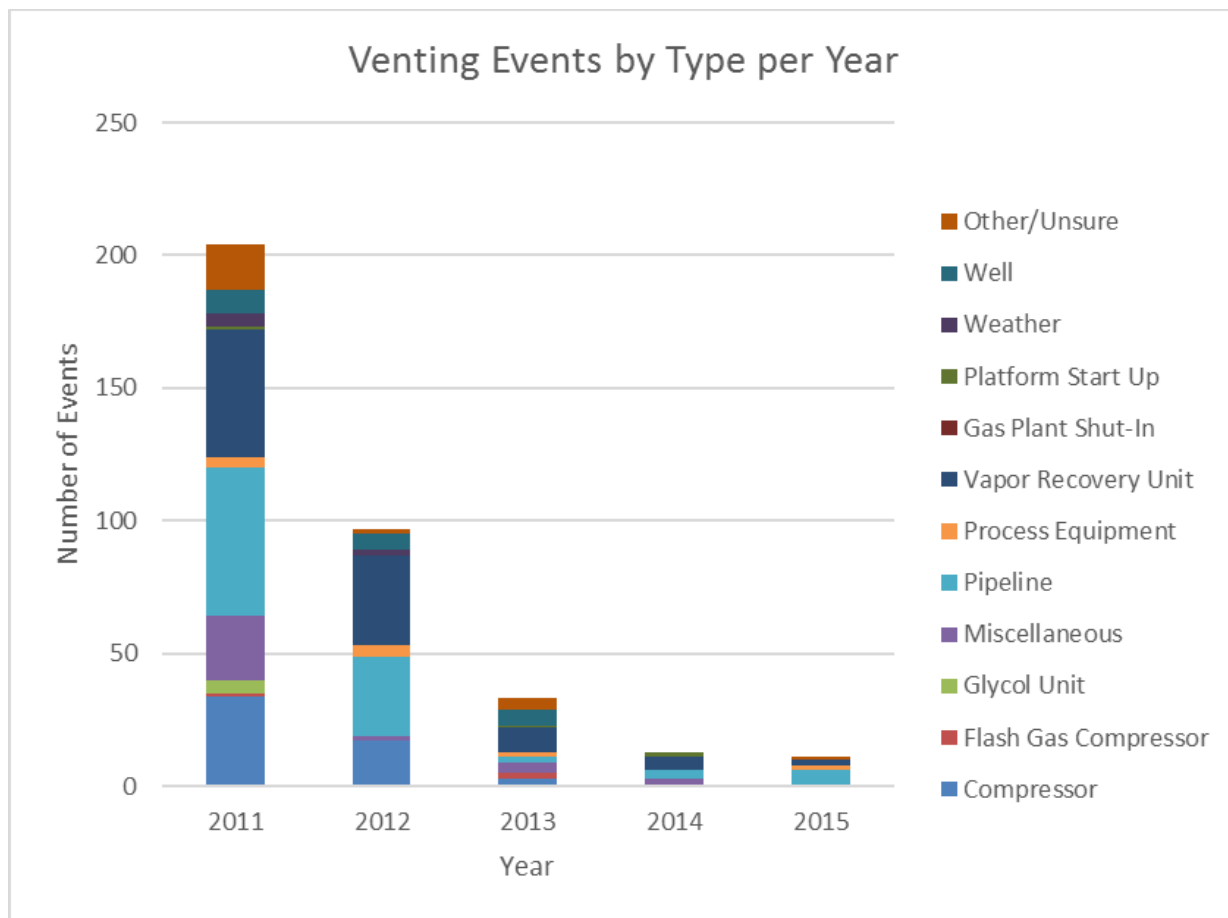

Figure 11: Number of Approved Events to Exceed Venting Limit.

## BSEE Venting and Flaring Research Study

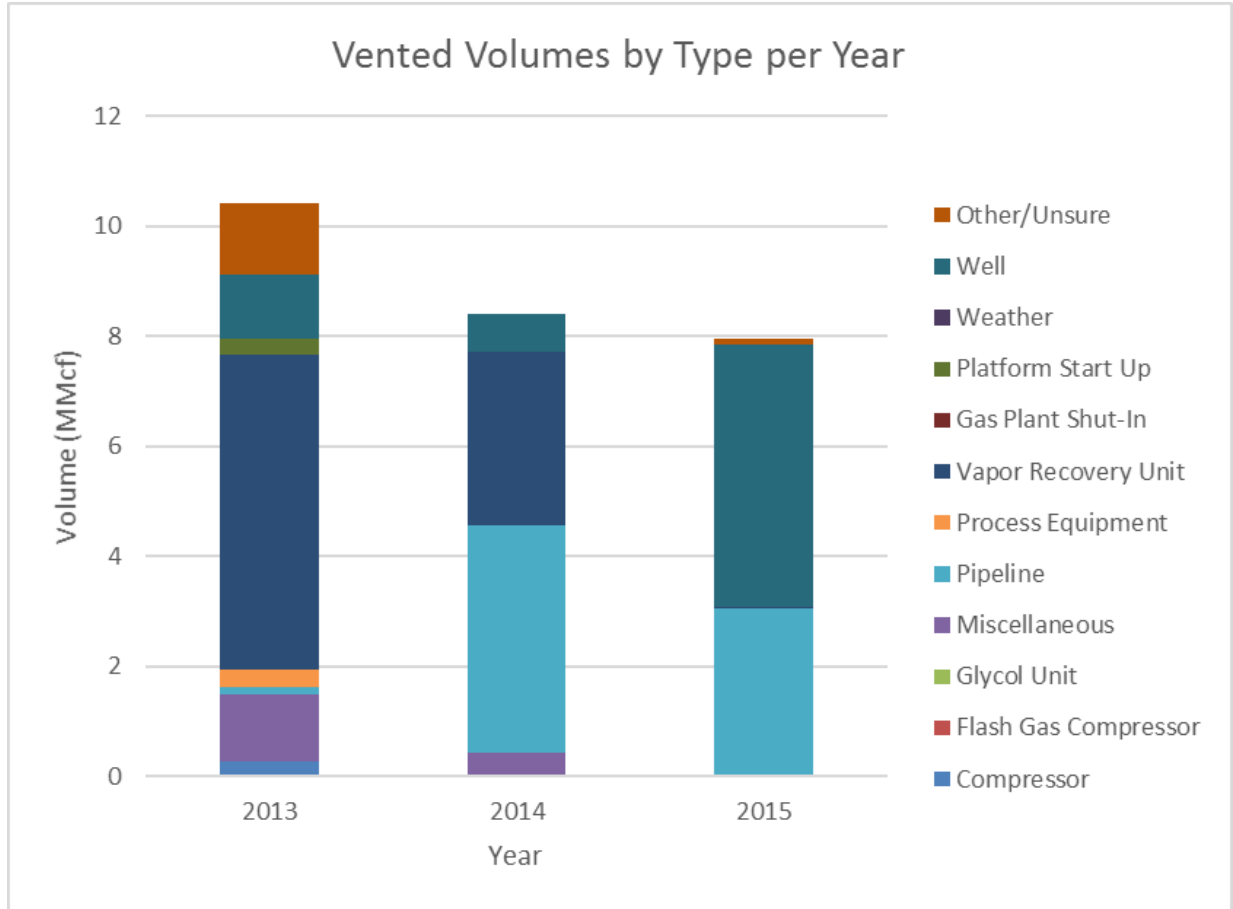

Figure 12: Volume Vented for Approved Events by Type.

## FORECASTED VENTING AND FLARING VOLUMES

Argonne analyzed historical information in the AVF-DB and developed correlation factors for estimating future venting and flaring volumes based on the type of structure and amount of natural gas produced. The flaring profile developed for floating structures is displayed in Table 3. The information presented indicates that the typical monthly volume (TMV) flared by a floating structure is equal to 0.7% of the amount of gas produced. During the first four (4) months of startup, a floating structure is estimated to flare 4.8 times its TMV flared. Ninety percent of floating structures are anticipated to have an estimated flare volume of 3.2 times the TMV flared in one month each year. In addition, 10% of floating structures have an estimated monthly spike of seven (7) times the TMV. A similar approach was applied to prepare venting and flaring profiles for single-well and fixed-leg structures.

**Table 3: Flaring Profile for Floating Structures.**

Structure Type	Typical Monthly Volume (TMV) as % of monthly gas production	Startup		Monthly Spike 1		Monthly Spike 2	
		Multiple of TMV	Duration (months)	Multiple of TMV	Percentage of Complexes	Multiple of TMV	Percentage of Complexes
Floating	0.7%	4.8	4	3.2	90%	7	10%

This study uses the low, medium, and high Exploration and Development (E&D) scenarios prepared by BOEM to estimate the annual amount of oil and gas produced each year and the number of operating complexes by structure type through 2045.

The AVF-DB was enhanced to include a forecast of monthly oil and gas production by facility from 2016 through 2045. For operating facilities in 2015, monthly oil and gas production was forecasted taking into account historical production levels and remaining reserves. New facilities were assigned an average monthly production level computed by structure type.

Lastly, the venting and flaring profiles described above were applied to monthly gas production values to estimate monthly venting and flaring volumes by facility. Aggregated annual venting and flaring volumes are displayed in the following figures.

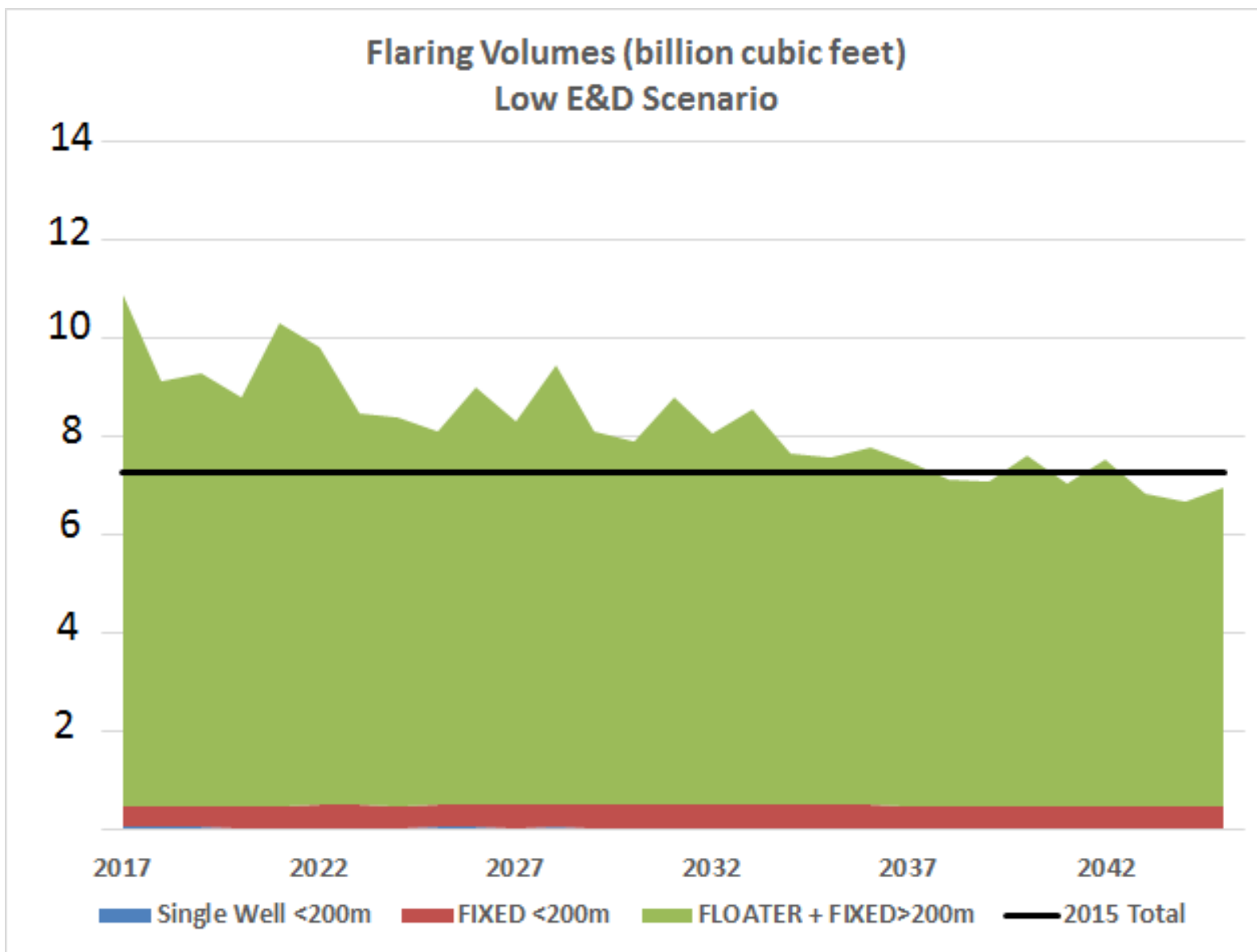

Figure 13: Estimated Annual Flaring Volumes for Low E&D Scenario.



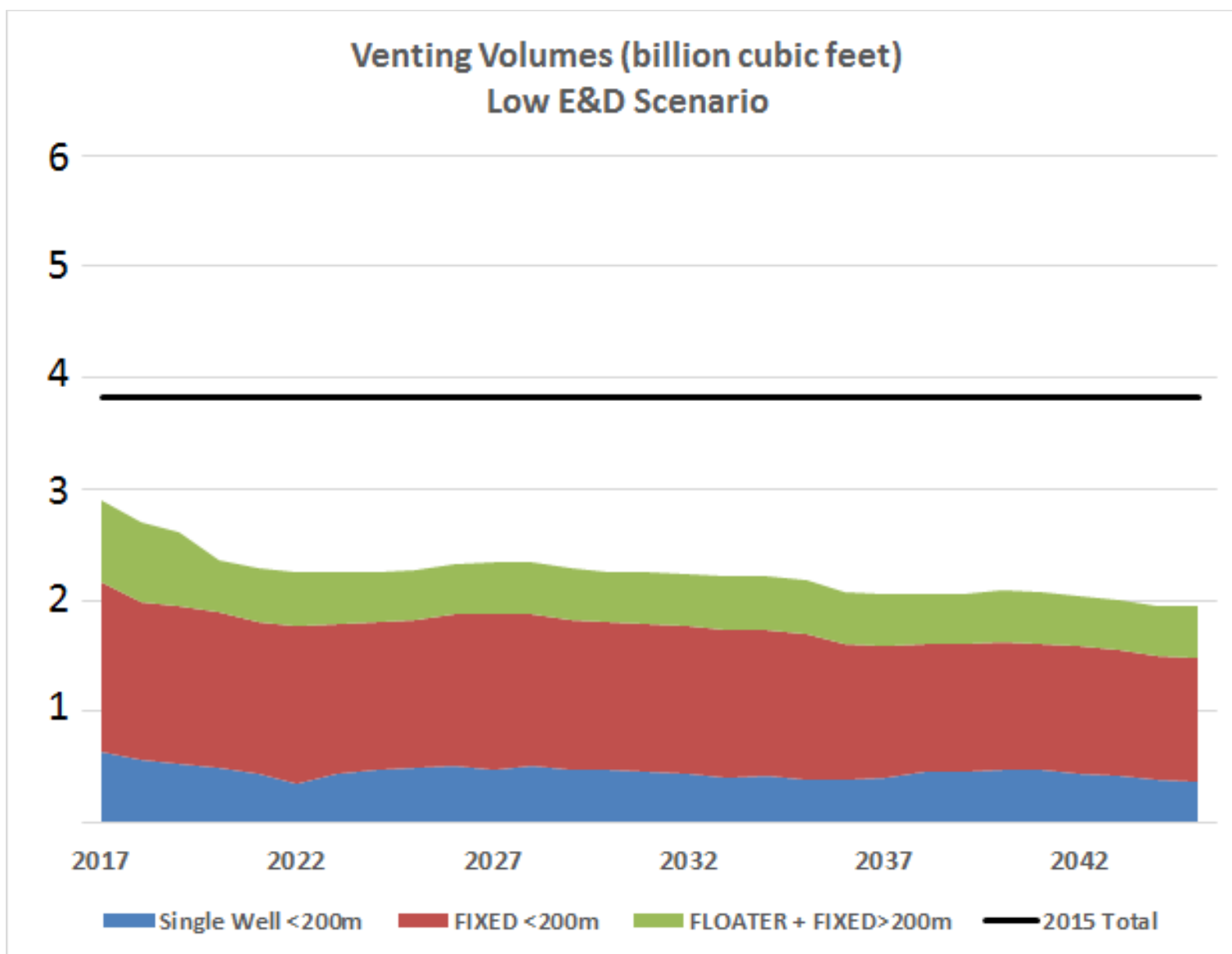

Figure 14: Estimated Annual Venting Volumes for Low E&D Scenario.

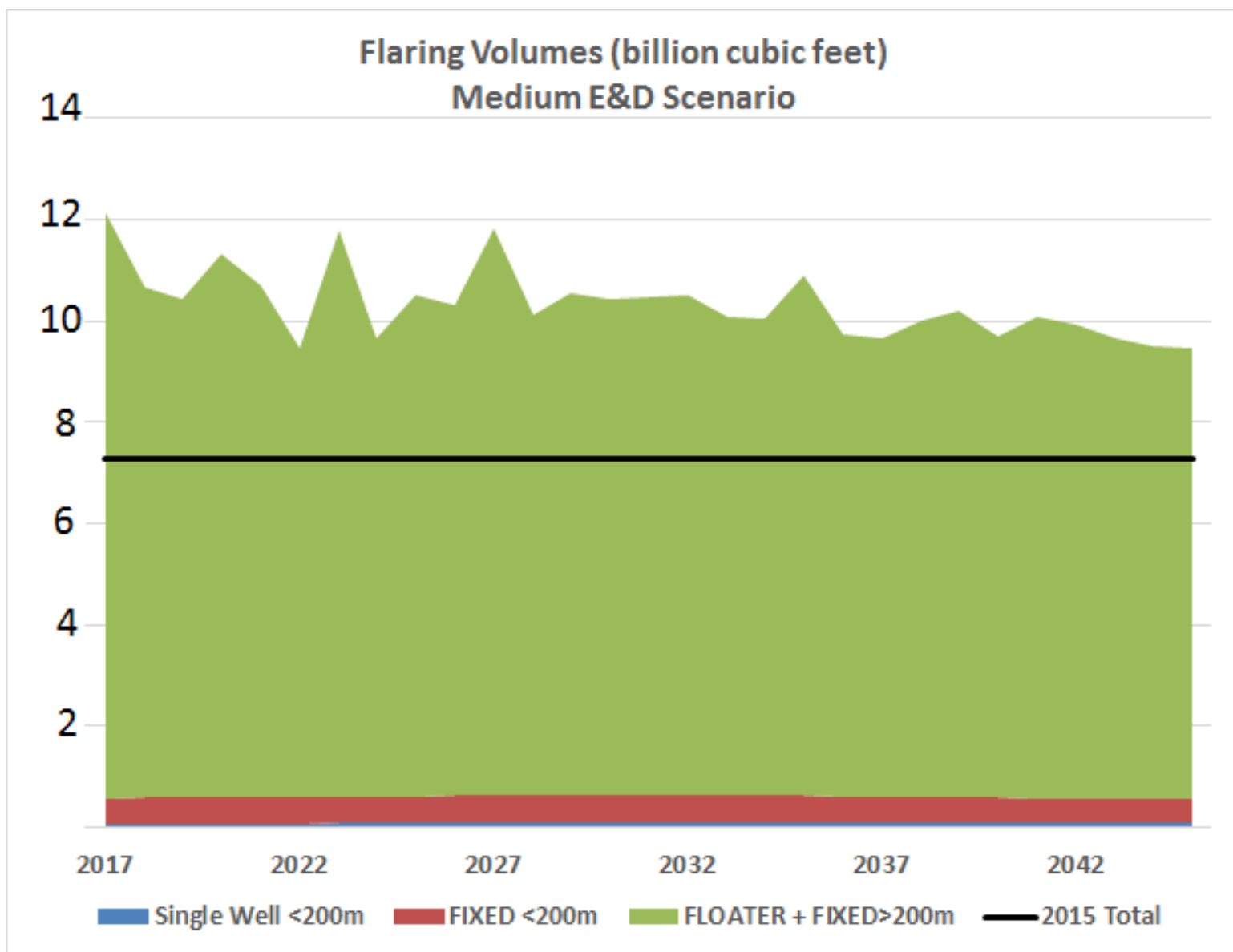

Figure 15: Estimated Annual Flaring Volumes for Medium E&D Scenario.

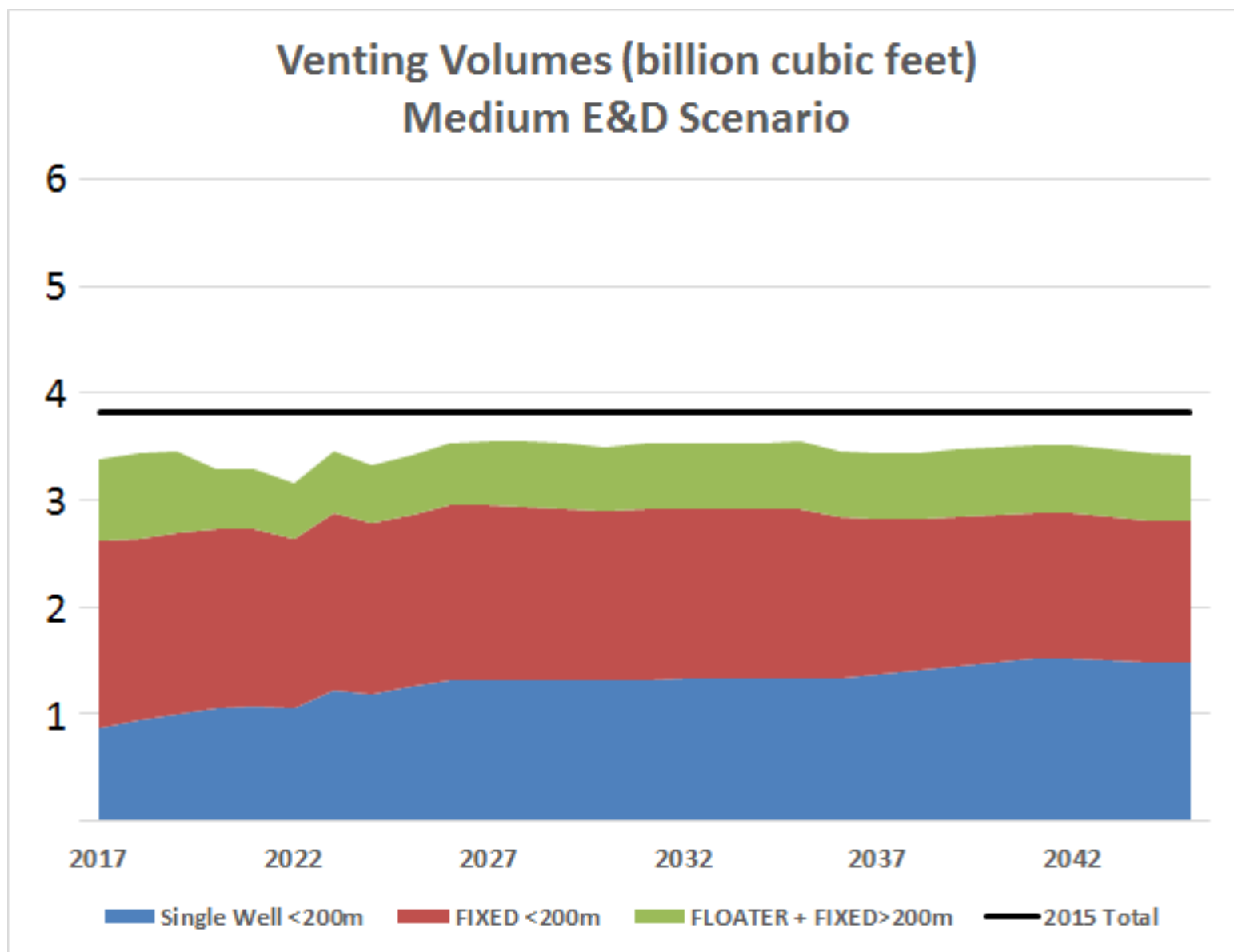

Figure 16: Estimated Annual Venting Volumes for Medium E&D Scenario.

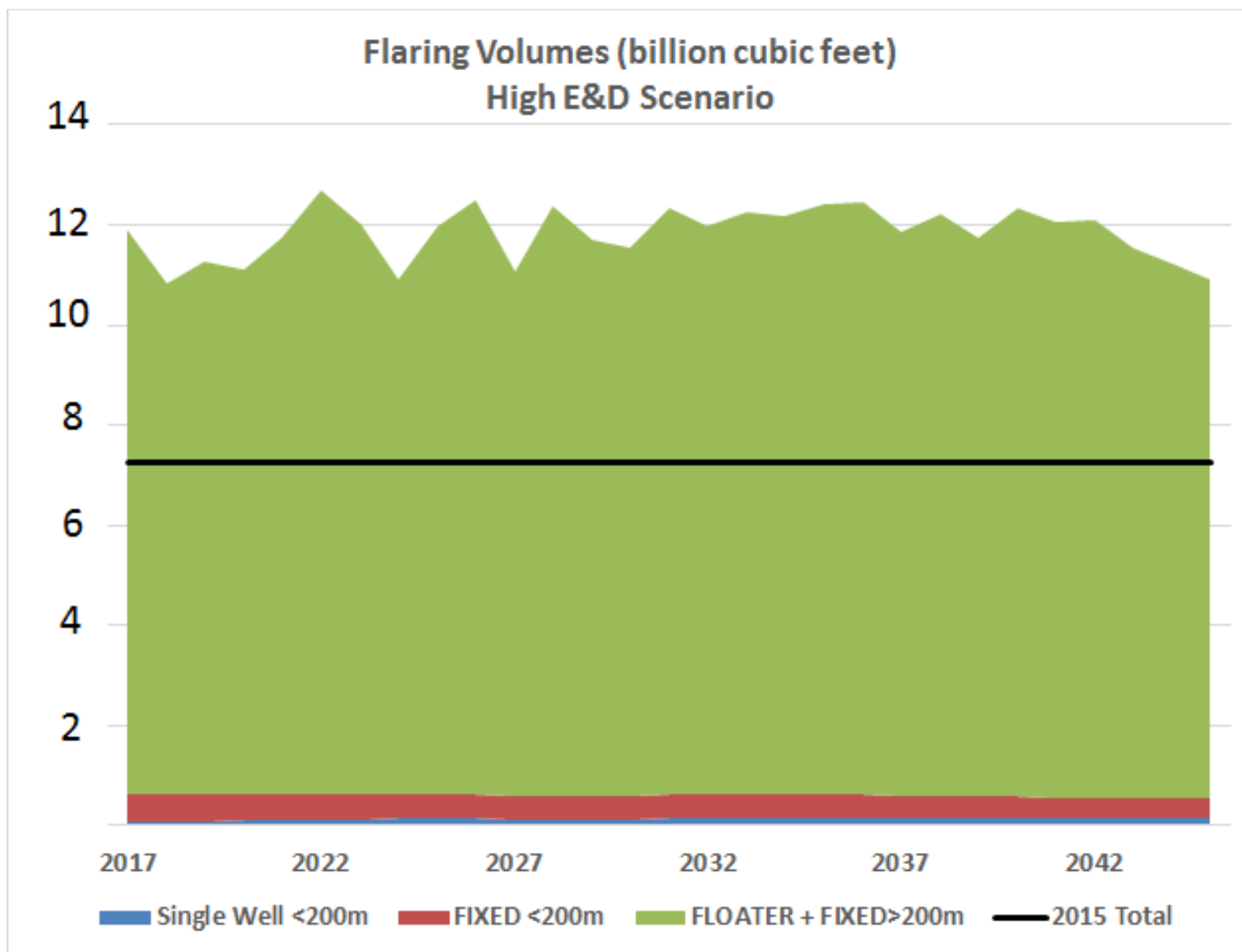

Figure 17: Estimated Annual Flaring Volumes for High E&D Scenario.

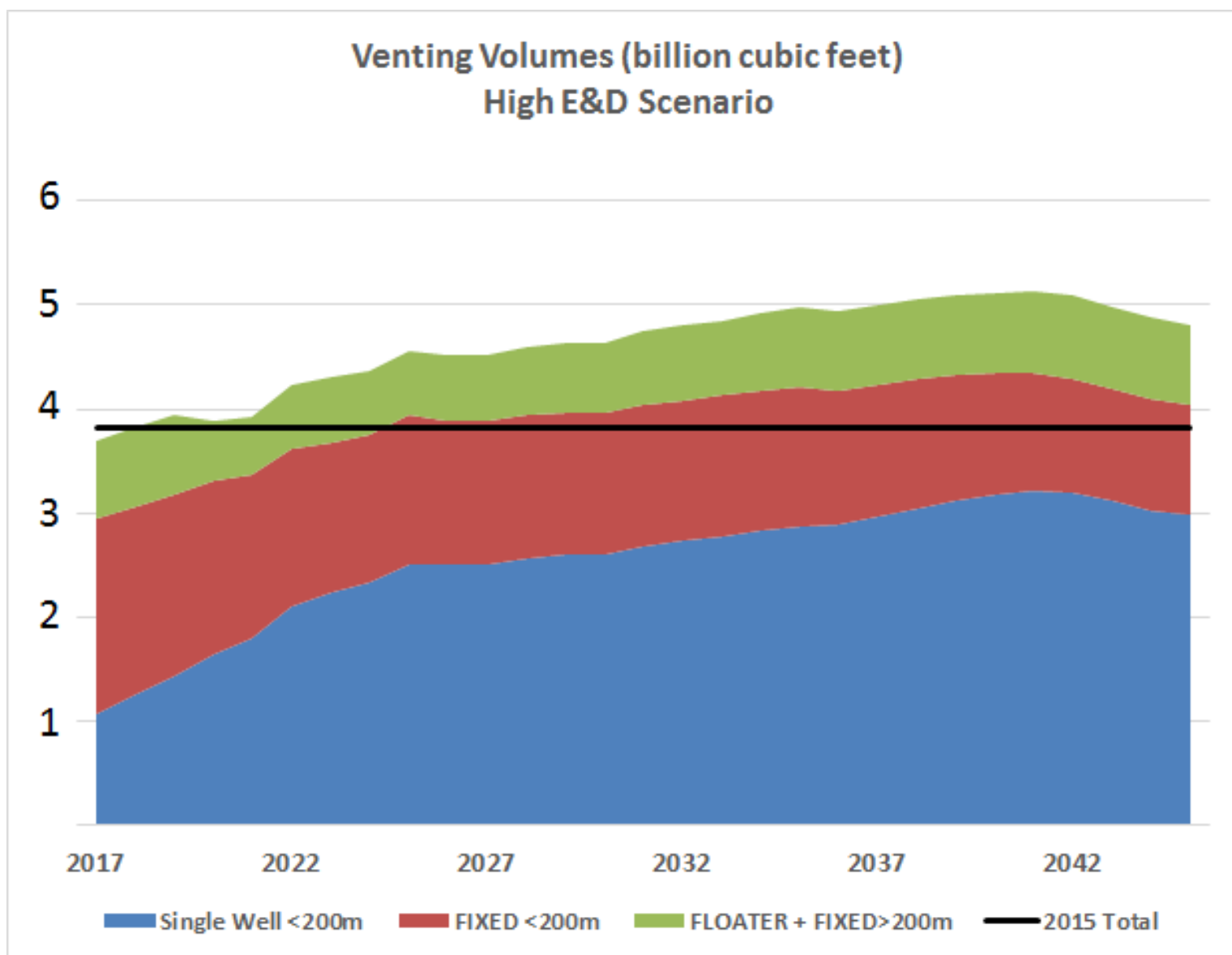

Figure 18: Estimated Annual Venting Volumes for High E&D Scenario.

## GAS CAPTURE TECHNOLOGY

### TECHNOLOGY OPTIONS

With a sound estimate of future venting and flaring volumes and improved insights into major sources, Argonne’s researchers focused on identifying viable technology options for capturing gas that would otherwise be vented or flared. This is not a speculative research and development initiative. Rather, this research focuses on technologies in operation at facilities on the OCS and new technologies being developed for use within the next few years.

In this study, the term “gas capture technology” encompasses a range of options (e.g., equipment, operating procedures, and cooperative actions) that can be applied on operating oil and gas production facilities to reduce the associated venting and flaring emissions. Potential gas capture technologies were identified based on Argonne Vent and Flare Research Team members’ research and engineering judgment, consultations with O&G industry professionals and regulators, and Environmental Protection Agency (EPA) Natural Gas STAR Program reports.

An initial set of 76 technologies (including 61 from the EPA Natural Gas STAR Program) were identified for review. Of these, 25 technologies were considered applicable to reducing vent and/or flare volumes from offshore production. An initial screening identified practical limitations associated with 8 of the 25, and the remaining 17 technologies were deemed viable options for capturing gas that would otherwise be vented or flared during offshore production. The gas capture technologies listed in Table 4 were selected for further evaluation in the cost-benefit analysis.

**Table 4: Gas Capture Technologies Evaluated in Cost-Benefit Analysis.<sup>70</sup>**

Technology Option		Description
1	Recover Gas from Pigging	Gases rich in recoverable hydrocarbons tend to condense liquids in offshore gas export pipelines. These systems are frequently pigged with spherical, disc, or bullet-shaped pigs to remove accumulated liquids. This improves gas flow and pipeline efficiency. The gas flow in the pipeline transports the pig; however, inserting and removing the pig (to or from a launcher or receiver) is a manual exercise. Opening the trap requires depressurizing the pig trap from normal export pressure to atmospheric pressure, usually to the flare. The majority of intermittently flared gas could be recovered and sold if it were depressurized to a low-pressure compressor prior to the final depressurizing to atmospheric conditions.
2	Maintain Pressure in Standby Compressors	While a compressor must be blown down before it can be restarted, the blowdown can occur either after initial shutdown or just before restart. Keeping systems fully or partially pressurized during an extended compressor shutdown can reduce venting and flaring emissions by preventing leaks through the unit isolation valves.

<sup>70</sup> See Appendix II for detailed technology briefings and a list of associated references.

3	Compressor Blowdown to Fuel Gas System	Compressors must periodically be taken offline for maintenance, operational standby, or emergency shutdown testing; and as a result, methane may be released to the atmosphere. When compressor units are shut down, the high-pressure gas remaining within the compressors and associated piping between isolation valves is typically released (in a “blowdown”) to a flare or to the atmospheric vent. Routing blowdown gas to the fuel gas system or to a lower-pressure gas line reduces fuel costs and avoids blowdown emissions.
4	Static Seals	In the offshore production industry, compressors recover flash gas (natural gas) from production wells and export it to pipelines. Normal practice is to depressurize (blow down) the compressor when it is shut down. However, when redundant compressors are installed and are available to run, one compressor may remain in a pressurized, standby mode. As a result, natural gas may be released to the atmosphere through rod packing seals. These fugitive emissions are not normally measured. Static seals installed on compression rods can eliminate the gas leaking back through the rod packing while a compressor is shut down under pressure.
5	Ejector	Periodically, compressors must be taken offline for maintenance, operational standby, or emergency shut-down testing, and as a result, methane may be released to the atmosphere. When compressor units are shut down, the high-pressure gas remaining within the compressors and associated piping between isolation valves is “blown down” to the flare or to the atmosphere. Changes in operating practices and in the design of blowdown systems can reduce methane emissions by keeping systems fully or partially pressurized during an extended compressor shutdown.
6	Capture Gas when Depressurizing Pipeline	Operators of natural gas pipeline systems routinely reduce line pressure and discharge gas from pipeline sections to ensure safe working conditions during maintenance and repair activities. The gas is typically discharged to a flare, but in some cases, it may be vented. If the work can be planned in advance, it may be possible to capture most of the gas rather than flare it.
7	Purge with Inert Gas	When pipeline segments are taken out of service for maintenance or repairs, it is common practice to depressurize the pipeline and vent the natural gas to the atmosphere. To prevent these emissions, a pig is inserted into the isolated section of the pipeline, and inert gas (nitrogen) is then pumped in behind the pig. The nitrogen pushes natural gas through to the product line. At the appropriate shutoff point, the pig is caught in a pig trap and the pipeline blocked off. Once the pipeline is “gas free,” the inert gas is vented to the atmosphere.
8	Reduced Completions	Reduced emissions completion—also known as reduced flaring completion or green completion—is a term used to describe a practice, mostly used onshore, that captures gas produced during well completions and well workovers following hydraulic fracturing. Portable equipment is brought onsite to separate the gas from the solids and liquids produced during the high-rate flowback and to produce gas that can be delivered into the sales pipeline if one can be easily accessed.
9	Foaming Agents	Foaming agents or surfactants (also called “soap”) can help lift accumulated liquids and temporarily restore production from the well without venting or flaring.

BSEE Venting and Flaring Research Study

10	Velocity Tubing	Another option to overcome liquid loading is to install smaller-diameter production tubing or “velocity tubing.” A velocity string reduces the cross-sectional area of flow and increases the flow velocity, achieving liquid removal without venting or flaring gas. The diameter of the velocity string is selected to lower the velocity required to lift the liquid, without significantly increasing the back pressure against the reservoir that would be caused by increased friction.
11	Flares	Remote and unmanned production sites may vent low-pressure natural gas and vapors from storage tanks and other onsite equipment to the atmosphere. These emissions can be reduced by installing flares to combust these gases instead of venting them to the atmosphere.
12	Gas Lift System	Many wells do not have sufficient pressure to allow oil or gas to rise to the surface naturally. A common approach to temporarily restore flow is to flow the well to atmospheric pressure (flare or vent to “unload” the liquids), which produces substantial emissions. In situations like these, artificial lift methods can be employed to enable well fluids to flow to the surface. Gas lift systems are commonly used for offshore well unloading. Compressed gas is injected down the annulus (space between the tubing and casing strings), through a valve or orifice at the bottom of the tubing and into the liquid that has built up in the tubing. The injected gas supplements the formation gas to form bubbles within the oil and water, which reduces viscosity and density. By lightening the liquid column with gas bubbles, the reservoir pressure is then able to lift the liquid column to the surface.
13	Microturbines	Microturbines provide an option for powering offshore operations using unprocessed wellhead gas.
14	Electric Submersible Pump	When a gas lift system has proven ineffective at a particular well, other options are available for artificial lift methods, including an electric submersible pump (ESP) system. ESP systems are well suited for high-rate, low-pressure wells, can provide as much as 15,000 feet of lift, and can be designed for temperatures up 500 degrees Fahrenheit.
15	Jet Pump	While well fluids typically need to be routed to a low-pressure system (e.g., flare or vent) in order to get the restarted well to flow, implementing a jet pump system allows the well to be restarted at normal system pressures. This significantly reduces the amount of vented and flared emissions.
16	Monitor Valves	After some time, pressure control valve(s) may begin to leak and release gas to the flare or vent system continuously. To avoid these additional emissions, increasing the monitoring of the flare and vent control valves will allow better detection of leaks and decreased flare and vent emissions upon repair of a leaking valve.
17	Redundant Compressor	Compressors are used throughout the offshore production industry to recover gas from production wells and to export it through pipelines. To avoid flaring, compressors must run any time the wells are flowing. Compressor downtime often results in high flare volumes and platform shut-ins, which can be remedied by the installation of redundant compressors.



## TECHNOLOGY BRIEFING TEMPLATE

Identified gas capture technologies and procedural changes were analyzed extensively to determine the associated operating and implementation requirements, applicability, emission reduction potential, and economic factors.

When designing a facility, operators must consider a multitude of factors related to the operating conditions, nature and type of reservoir, regulatory requirements, facility design limitations, operating practices, safety, and economics. Argonne prepared a standardized technology briefing template to provide additional information on each of the technologies identified in Table 4. This information (Appendix II) can help operators evaluate whether implementing any of the identified gas capture techniques is advantageous for their current or future facility configurations.

The technology briefing templates also present a checklist with the Argonne Venting and Flaring Research Team’s assessment of typical applications for the described technology or procedural change. An example checklist is displayed at right (Figure 19). Checklists are broken down into four separate sections:

1. Applicable Application(s);
2. Applicable Modification(s);
3. Applicable Structure(s); and
4. Applicable Equipment Type(s).

<b>Applicable Application(s)</b>	
<input checked="" type="checkbox"/>	New Construction
<input checked="" type="checkbox"/>	Retrofit
<b>Applicable Modification(s)</b>	
<input checked="" type="checkbox"/>	Hardware/Equipment
<input type="checkbox"/>	Process
<b>Applicable Structure(s)</b>	
<input type="checkbox"/>	Well-Only Platforms
<input checked="" type="checkbox"/>	Fixed Platforms
<input checked="" type="checkbox"/>	Floating Platforms (SPAR/TLP/CT/Semi-Sub)
<b>Applicable Equipment Type(s)</b>	
<input checked="" type="checkbox"/>	Flare
<input checked="" type="checkbox"/>	Cold Vent

Figure 19: Technology Briefing Checklist.

The Applicable Application(s) section indicates whether a recommended technology/procedural change can be implemented only on platforms being newly constructed (indicated by a check mark next to ‘new construction’), whether the recommended change will only work when retrofitting an existing facility (indicated by a check mark next to ‘retrofit’), or if a recommended change can apply in both situations. If applicable in both cases, both check boxes will be marked.

The Applicable Modification(s) section indicates the primary type of change that is involved for each template. This will either be a change that involves implementing new equipment or hardware onto the facility (indicated by a check mark next to ‘hardware/equipment’) or implementing a change to a procedural aspect (indicated by a check mark next to ‘process’). If both boxes in this section are marked, this indicates a change will involve both equipment and procedural modifications.

The Applicable Structure(s) section indicates exactly what type of facility a new technological/procedural change will apply towards. A check mark next to each different type of facility indicates whether it is applicable towards that structure. One recommended change may apply towards more than one type of facility, which will be indicated by multiple boxes being marked in this section.

The final section of the technology briefing template includes the Applicable Equipment Type(s) associated with a recommended technology change. This will either involve a direct impact on flaring volumes (indicated by a check mark next to ‘flare’), a direct impact on venting volumes (indicated by a check mark next to ‘cold vent’), or both flaring and venting if there is a check mark next to both subjects in this section.

## COST-BENEFIT ANALYSIS

### INTRODUCTION

With a sound forecast of monthly venting and flaring volumes for over 1,300 existing complexes on the OCS, established scenarios of future development, and an identified set of gas capture technology best practices, Argonne’s research focused on the use of quantitative methods to develop a structured analytical framework for estimating monetized values of the costs and benefits associated with implementing each gas capture technology on suitable complexes.

A technology cost-benefit analysis (CBA) model was developed to quantify the costs and benefits of reducing venting and flaring in offshore operations. This evaluation of the benefits and costs of different technology options accounts for costs to the environment, opportunity costs to society, revenue, and estimated capital and operating costs. The 17 technology options listed in Table 4 were analyzed to determine when available natural gas capture technologies would be cost beneficial from a societal perspective. The value of capture technologies is presented in terms of net present value (NPV), the amount of reduced emissions, the percent of reduced emissions relative to a no-action case, and the break-even social cost of carbon.

The question addressed in the CBA is not only whether a particular capture technology is cost beneficial as a single strategy, but also under what situations a range of potential capture technology is cost beneficial. In evaluating the results of the CBA, a number of factors affect the analysis of gas capture technologies. These factors include the price of natural gas, the social value of reducing emissions, the efficiency of technologies in capturing gas, capital and operating cost of technologies, the status of existing technology at the facility, the remaining lifetime of facility operations, the E&D production forecast, and other factors. Because the costs and benefits are affected by a variety of different assumptions, the final cost-benefit analysis is presented as a series of different scenarios rather than a single point estimate.<sup>71</sup>

---

<sup>71</sup> Some of the technologies have benefits beyond emission reductions (e.g., gas lift and foaming agents may improve overall reserves recovery). This study did not include those benefits.

This section is divided into three major parts. The first part describes the methodology, data, and assumptions used to measure benefits and costs of alternative technologies and regulatory restriction options. The process of measuring benefits and costs is described with mathematical equations as well as documentation of the cost-benefit model.

The next part summarizes technology benefits and costs for particular offshore production complexes. This part explains the most important drivers of the analysis and reasons why some technologies are more cost beneficial than others.

The final part of this section presents aggregated OCS-wide results of evaluated scenarios. This section accounts for the fact that technology options would not apply to every complex because some of the complexes already have installed various forms of gas capture technology and some technology options are not suitable for all types of structures.

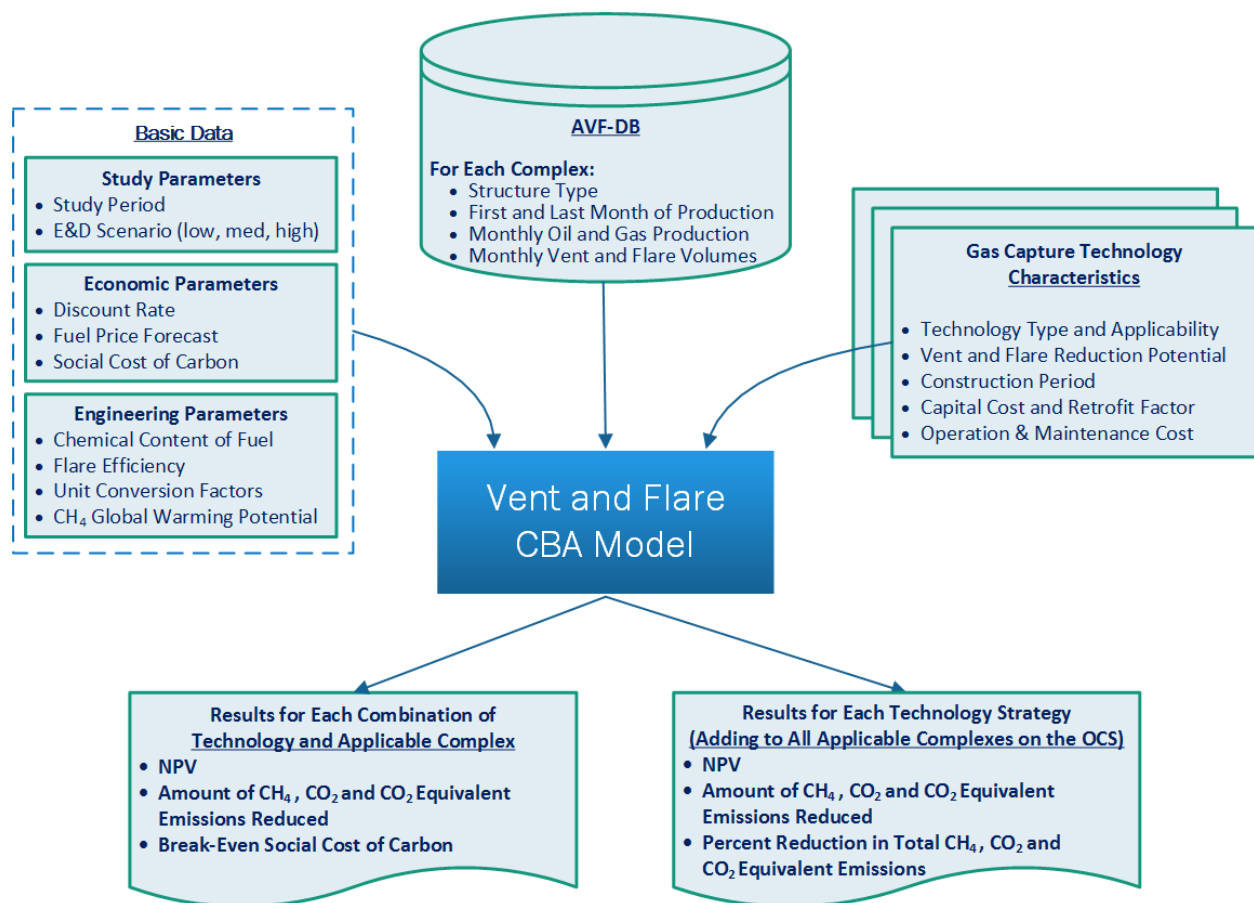

Figure 20: Conceptual Design of Technology CBA Model.

## CBA METHODOLOGY

### Input Data and Assumptions

The conceptual design of the Technology CBA Model developed for measuring benefits and costs described in this report is illustrated in Figure 20. The flowchart demonstrates that three primary data sources are used in the analysis: (1) basic data on natural gas and oil price, discount

rates, and emission conversion factors; (2) the AVF-DB, which contains monthly oil production, gas production, venting quantities in a no-action alternative, and flaring quantities in a no-action alternative for each offshore production complex; and (3) a dataset that includes characteristics of alternative gas capture technologies. The following parameters are used in measuring benefits and costs of implementing technology options on each applicable complex.

**Study Period:** The period of analysis for the CBA spans from January 2016 through December 2045.

**Discount Rate:** In measuring NPV, the CBA is performed in constant dollars and applies a real discount rate of 3%. No income taxes or royalty taxes are included in the net present value analysis, as these amounts are transfers that do not affect the inherent benefits or costs to society overall.

**Social cost of carbon (SC-CO<sub>2</sub>):** Executive Order 12866 requires federal agencies “to assess both the costs and the benefits of the intended regulation and, recognizing that some costs and benefits are difficult to quantify, propose or adopt a regulation only upon a reasoned determination that the benefits of the intended regulation justify its costs.”

Since 2010, an Interagency Working Group (IWG) on the Social Cost of Greenhouse Gases (formerly the Interagency Working Group on the Social Cost of Carbon) has estimated values of monetized damages associated with an incremental increase in carbon emissions, called the social cost of carbon, for use by federal agencies when analyzing the costs and benefits of regulatory actions. A technical support document with updated guidance, issued in August 2016, notes that:

*Current guidance contained in OMB Circular A-4 indicates that analysis of economically significant proposed and final regulations from the domestic perspective is required, while analysis from the international perspective is optional. However, the IWG (including OMB) determined that a modified approach is more appropriate in this case because the climate change problem is highly unusual in a number of respects. First, it involves a global externality: emissions of most greenhouse gases contribute to damages around the world even when they are emitted in the United States—and conversely, greenhouse gases emitted elsewhere contribute to damages in the United States. Consequently, to address the global nature of the problem, the SC-CO<sub>2</sub> must incorporate the full (global) damages caused by GHG emissions.<sup>72</sup>*

For completeness, Argonne researchers computed the cost-effectiveness of emissions control technologies using both the domestic and global SC-CO<sub>2</sub>, and also computed break-even SC-CO<sub>2</sub> values associated with the application of each emission control technology to each applicable facility on the OCS.

---

<sup>72</sup> Technical Support Document: Technical Update of the Social Cost of Carbon for Regulatory Impact Analysis Under Executive Order 12866, August 2016, page 13 (“TSD: SCC Update 2016”).

The standard global SC-CO<sub>2</sub> assumption<sup>73</sup> to use the 3% discount rate value of 42 dollars per metric ton of CO<sub>2</sub> for the year 2020 (in 2007 dollars) was adjusted for inflation to 2016 dollars (inflation of 16%), which is \$48.62, rounded to \$49 per metric ton CO<sub>2</sub>. To compute the U.S. domestic value, the global SC-CO<sub>2</sub> is multiplied by 23%, reflecting the amount of GDP the U.S. contributes to the global economy. The resulting value of 11.27 is used in this study as the base value of domestic SC-CO<sub>2</sub> in 2016 Dollars per metric ton CO<sub>2</sub>.<sup>74</sup>

The IWG asserts that “future emissions are expected to produce larger incremental damages as physical and economic systems become more stressed in response to greater climatic change, and because GDP is growing over time and many damage categories are modeled as proportional to gross GDP.” This study uses the established average annual growth rate for the standard SC-CO<sub>2</sub> of 3.2% for 2017-2020, 2.1% for 2021-2030, 1.9% for 2031-2040, and 1.6% for 2041-2045.<sup>75</sup>

**Methane (CH<sub>4</sub>) Global Warming Potential (GWP):** This study uses a value of 25 for the GWP of CH<sub>4</sub>,<sup>76</sup> which indicates that methane emissions are multiplied by 25 times to convert to CO<sub>2e</sub> volumes.

**Fuel Price Forecast:** The future price of natural gas is an important item in deriving costs and benefits of different gas capture technology alternatives. Rather than attempting to predict gas and oil prices, this study relied on price forecasts from published sources, including the Energy Information Agency (EIA), the NYMEX exchange, and the World Bank. Namely the following four sources for oil and gas prices have been applied:

- (1) The EIA long-term forecast published in May 2016;
- (2) The EIA short-term forecast published in October 2016;
- (3) The World Bank forecast published in April 2016; and
- (4) The NYMEX futures on October 28, 2016.

In applying the forecasts to the CBAs, certain adjustments were required. First, the forecasts are for different time periods. Second, some of the forecasts are in nominal dollars, and others are in real dollars. Third, some of the natural gas forecasts are in dollars per Mcf, while others are in dollars per MMBTU. Therefore, the following adjustments have been made to the forecasts:

- (1) As the longest forecast is the EIA long-term forecast, for the other forecasts (NYMEX and World Bank), the percentage change in the EIA forecast price was applied beyond the last year of those published forecasts.
- (2) Since the NYMEX prices are in nominal dollars, the prices are deflated using the inflation index included in the EIA forecast (the EIA long-term forecast includes both real and nominal data).
- (3) Since the venting and flaring data are in Mcf, the forecasts that are stated in dollars per MMBTU are converted to dollars per Mcf using 1.032 MMBTU/Mcf.<sup>77</sup>

<sup>73</sup> TSD: SCC Update 2016, page 16.

<sup>74</sup> Given that one metric ton equals 1.1023 short tons, the value of 11.27 \$/tonne equates to 10.22 \$/ton.

<sup>75</sup> TSD: SCC Update 2016, page 17.

<sup>76</sup> IPCC Fourth Assessment Report: Climate Change 2007

[http://www.ipcc.ch/publications\\_and\\_data/ar4/wg1/en/ch2s2-10-2.html](http://www.ipcc.ch/publications_and_data/ar4/wg1/en/ch2s2-10-2.html)

<sup>77</sup> <http://www.eia.gov/tools/faqs/faq.cfm?id=45&t=8>

## BSEE Venting and Flaring Research Study

The final set of natural gas price forecasts and oil price forecasts (in constant 2016 dollars) used in the CBA analysis are illustrated on Figure 21 and Figure 22. The EIA Long-Term forecast was selected for the CBA base case and alternative scenarios were evaluated using the EIA Low Resource and Flat Real forecasts.

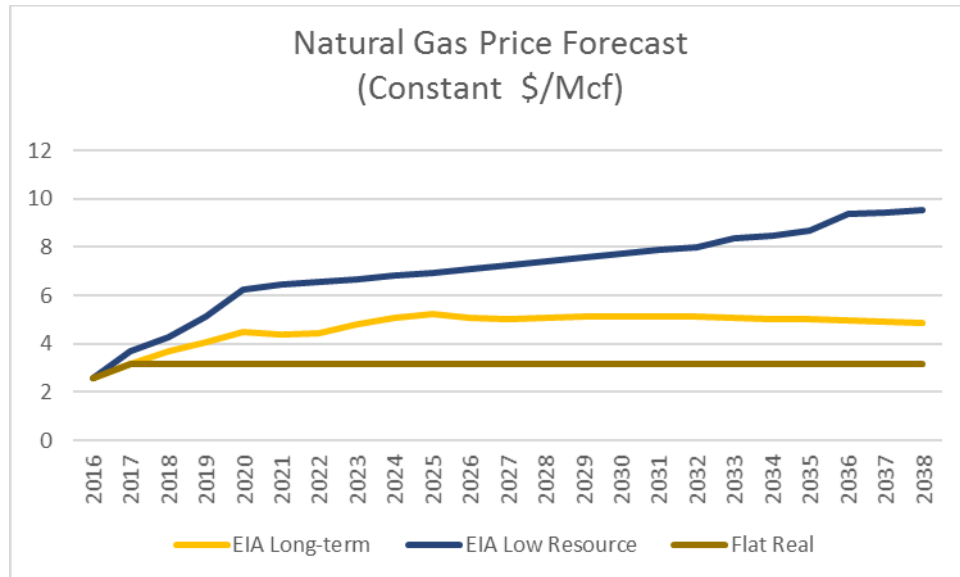

Figure 21: Alternative Natural Gas Price Forecasts.

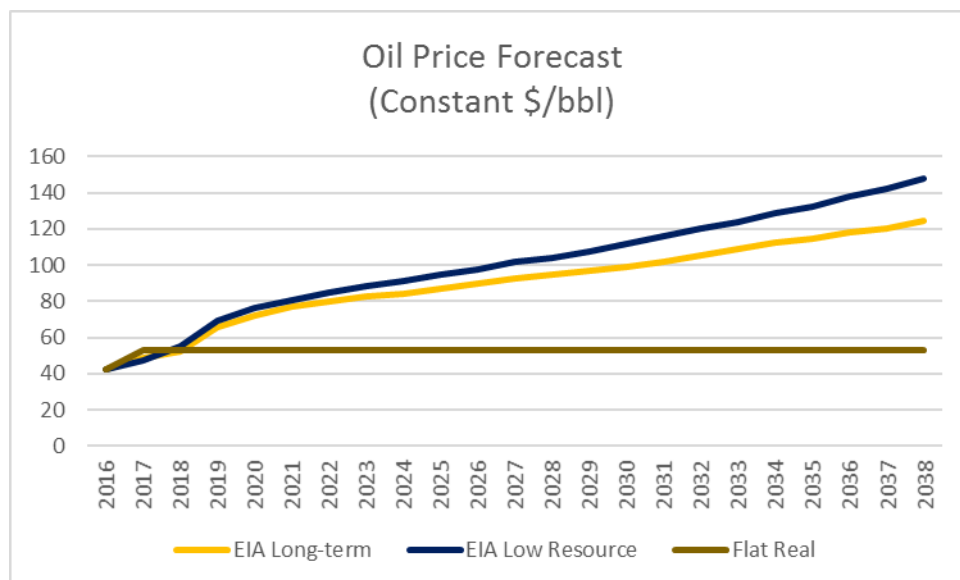

Figure 22: Alternative Oil Price Forecasts.

**Gas Capture Technology Characteristics:** The Argonne Venting and Flaring Research Team includes specialists in energy economics and policy, petroleum engineering, production facility operations, and chemistry. The team’s research produced estimated technical and economic characteristics for the 17 technologies evaluated with the Technology CBA Model (Table 5).

**Table 5: Technical and Economic Characteristics for Evaluated Gas Capture Technologies.**

Technology Option	Category	Construction Period (Months)	Gas Capture Estimate			Capital Cost (k\$)		Maintenance	
			Amount	Units	Frequency (Months)	New	Retrofit	Cost (k\$)	Frequency (Months)
1 Recover Gas from Pigging	Pipelines	4	0.68388	Mcf	0.25	100	200	10	60
2 Maintain Pressure in Standby Compressors	Compressors/Engines	3	0.4275	Mcfh	Continuous	7.5	15	0	0
3 Compressor Blow down to Fuel Gas System	Compressors/Engines	6	1.3	Mcf	0.5	107.5	215	0	0
4 Static Seals	Compressors/Engines	6	0.135	Mcfh	Continuous	50	100	0	0
5 Ejector	Compressors/Engines	12	15	Mcf	0.5	100	200	5	60
6 Pipeline Pump-Down	Pipelines	1	16	Mcf	12	30	30	0	0
7 Purge with Inert Gas	Pipelines	1	16	Mcf	12	50	50	0	0
8 Reduced Completions	Wells	6	10000	Mcf	6	100	200	0	0
9 Foaming Agents	Wells	3	100	Mcf	0.5	10	10	0	0
10 Velocity Tubing	Wells	12	100	Mcf	0.5	10000	20000	0	0
11 Flares	Other	12	50	Mcfd	Continuous	2100	4200	30	60
12 Gas Lift System	Wells	6	100	Mcf	0.5	105	210	10	60
13 Microturbines	Compressors/Engines	12	10	Mcfd	Continuous	2500	5000	100	120
14 Electric Submersible Pump	Wells	18	100	Mcf	0.5	6000	12000	2000	24
15 Jet Pump	Wells	18	100	Mcf	0.5	5000	10000	0	0
16 Monitor Valves	Compressors/Engines	0	0.4	Mcfh	Continuous	0	0	20	6
17 Redundant Compressor	Compressors/Engines	24	10	MMcf	0.5	20000	20000	100	120



**Avoided CH<sub>4</sub> and CO<sub>2</sub> emissions:** Emission estimates are computed as a function of the monthly natural gas production at the complex and the chemical content of the gas.

Venting emissions of CH<sub>4</sub> are estimated using the following equation:<sup>78</sup>

$$E_{\text{vent,CH}_4} = P_{\text{CH}_4} \times \frac{W_{\text{gas}} \left( \frac{\text{lbs}}{\text{lb-mole}} \right)}{.3794 \left( \frac{\text{Mcf}}{\text{lb-mole}} \right)} \times \left( \frac{1 \text{ ton}}{2000 \text{ lbs}} \right) \times V$$

where:

$E_{\text{vent,CH}_4}$  = CH<sub>4</sub> emissions in tons

$P_{\text{CH}_4}$  = Percent by weight of CH<sub>4</sub> in sales gas (default = 88.165592)

$W_{\text{gas}}$  = Molecular weight of sales gas (default = 17.2)<sup>79</sup>

$V$  = Volume of natural gas vented (Mcf)

Vent emissions of CO<sub>2</sub> are estimated using the following equation:

$$E_{\text{vent,CO}_2} = P_{\text{CO}_2} \times \frac{W_{\text{gas}} \left( \frac{\text{lbs}}{\text{lb-mole}} \right)}{.3794 \left( \frac{\text{Mcf}}{\text{lb-mole}} \right)} \times \left( \frac{1 \text{ ton}}{2000 \text{ lbs}} \right) \times V$$

where:

$E_{\text{vent,CO}_2}$  = CO<sub>2</sub> emissions in tons

$P_{\text{CO}_2}$  = Percent by weight of CO<sub>2</sub> in sales gas (default = 2.04796139)

$W_{\text{gas}}$  = Molecular weight of sales gas

$V$  = Volume of natural gas vented (Mcf)

Similar equations have been applied to estimate flaring emissions, while also accounting for flare efficiency and combustion effects. Based on these formulas, the research team computed emission factors expressed in tons of CH<sub>4</sub> and CO<sub>2</sub> avoided relative to the volume of gas captured. Emission factors listed in Table 6 are used in the Technology CBA Model.

---

<sup>78</sup> BOEM, Year 2011 Gulfwide Emission Inventory Study, November 2014, page 59.

<sup>79</sup> BOEM, Year 2011 Gulfwide Emission Inventory Study, November 2014, page 53.



**Table 6: Emission Factors for CH<sub>4</sub> and CO<sub>2</sub> Relative to Amount of Gas Captured.**

Emission		
Source	Pollutant	Factor (ton/MMcf)
Vent	CH <sub>4</sub>	19.985
	CO <sub>2</sub>	0.4642
Flare	CH <sub>4</sub>	0.7914
	CO <sub>2</sub>	53.246

### Single-Complex Analysis of Technology Benefits and Costs

Once the input data is consolidated, the core computation of the CBA is performed on a complex-by-complex basis. The cost-benefit model for each complex is a standard economic model with cash flows computed on a monthly basis. Cash outflows for capital expenditures and periodic maintenance associated with a particular technology are compared to revenues directly generated from natural gas recovery and the social value of reduced emissions.

The cost-benefit model encompasses venting and flaring data ranging from January 2016 through December 2045. Each gas capture technology option has a defined start date, which is the first month that the technology could be applied after a period of construction. Costs and benefits of different gas capture technologies depend in part on the date at which a complex ceases production and, for new technologies, the date at which the complexes commence operations. As the technology options involve up-front capital expenditures, if a complex has a short remaining life, the technology is less likely to be beneficial for the operator. In order to allow for sufficient operating lifetime to fairly quantify benefits, this study did not add gas capture technologies to new facilities added near the end of the study period.<sup>80</sup>

Once construction and operation time periods are established for each technology-complex combination, the following steps are taken to determine the economic viability of implementing the gas capture technology at the complex.

1. Estimate amount of recovered natural gas;
2. Estimate amount of avoided CH<sub>4</sub> and CO<sub>2</sub> emissions;
3. Estimate technology benefits in terms of monetary value of monthly captured gas and avoided emissions;
4. Estimate costs associated with technology construction, operation, and maintenance; and
5. Compute NPV associated with projected benefits and costs.

<sup>80</sup> Argonne researchers estimate the handling of study-period end effects in the current Technology CBA Model underreports the OCS-wide CO<sub>2</sub>e emission reduction potential for floating structures, in the high E&D scenario, by approximately 10%.

**Recovered natural gas:** Gas capture data provided in Table 5 are used to estimate monthly gas recovered through use of the gas capture technology. For some technologies, the natural gas recovery is intermittent, and for others, capture is continuous. For example, maintaining pressure in standby compressors (“Technology 2”) provides continuous recovery at a rate of 0.43 thousand cubic feet per hour of operation (Mcfh), while capturing gas when depressurizing a pipeline (“Technology 6”) provides an intermittent recovery of 16 Mcf every 12 months.

For both intermittent and continuous emission reductions, natural gas recovery is converted to a monthly basis in the cost-benefit model for a single complex. For example, if the volume of gas captured is reported on a daily basis in the technology database, this is converted to monthly amounts using an average 30.4-day month. For technology options where the period between gas reductions is greater than a month, the recovered volume of gas emitted is only applied in the months consistent with that period. Each of these technologies results in a specific amount of natural gas recovered in each month, which are expressed as cost-benefit model results in terms of Mcf per month.

**CO<sub>2e</sub> emission estimates:** The amount and mix of carbon dioxide and methane emission reductions varies for each technology and is a function of the natural gas recovered. For some technologies, reduced emissions are derived from flaring, and for others, the recovered gas reduces vented emissions. Further, the amount of emission reductions per volume of natural gas recovered for methane and carbon dioxide depends on whether flaring or venting occurs. Each of the technologies will either influence vented, flared, or both manners in which natural gas can escape into the atmosphere. Therefore, the technologies are denoted as a ‘flare strategy’ if the technology solely impacts flared volumes, a ‘vent strategy’ if it impacts vented volumes, or an ‘either strategy’ if either type of emission could be impacted. Those with “either strategy” reduced flare volumes if flare volumes were forecasted; otherwise, they reduced vented volumes.

One of the technologies involves installing a flare system. This strategy was given a special denotation of ‘vent convert to flare strategy’ since the vented emissions are converted into flared emissions. The model for this technology accounts for a decrease in vented emissions and an increase in flared emissions.

The general process of converting natural gas captured to CO<sub>2e</sub> emissions is represented by the following equation:

$$E_{CO_{2e}} = V \times F_{CO_2} + V \times F_{CH_4} \times G_{CH_4}$$

where:

$E_{CO_{2e}}$  = CO<sub>2</sub> equivalent emissions in tons per month

$F_{CO_2}$  = Constant defined in Table 6 (ton/Mcf)

$F_{CH_4}$  = Constant defined in Table 6 (ton/Mcf)

$G_{CH_4}$  = Global warming potential of CH<sub>4</sub> (equals 25)

$V$  = Volume of recovered natural gas (Mcf)

The Technology CBA Model performs a check to ensure the amount of emissions reduction per month for a given complex does not exceed the average emissions from the subsequent twelve months. If the natural gas capture amounts are less than the next twelve months’ emissions, then the full benefit of reduced emissions will apply.

For the ‘vent convert to flare’ technology option, the emissions that were originally vented are converted to flared emissions. In this case, the technology has a benefit of reduction in vented methane and carbon dioxide emissions, while also having a cost associated with an increase in flared methane and carbon dioxide emissions.

**Computation of Benefits:** Once the estimated amount of recovered natural gas and reduced emissions are collected computed in the CBA model for a single complex, costs and benefits are quantified on the basis of estimated revenues, capital expenditures, and operating costs. Revenue (i.e., benefit) calculations are demonstrated with the formulas below.

Revenue from recovered natural gas is estimated using the following equation:

$$G_t = P_t \times V_t$$

where:

- G = Total monthly revenue from recovered gas (\$)
- P = Price of natural gas (\$/Mcf) – value varies with time
- V = Volume of natural gas recovered (Mcf)
- t = The time period (month)

Value of avoided emissions is estimated using the following equation:

$$C_t = S_t \times E_{CO_{2e}t}$$

where:

- C = Total monthly value of avoid emissions (\$)
- S = Social cost of carbon expressed in real (2016) dollars per ton of CO<sub>2e</sub>
- E<sub>CO<sub>2e</sub></sub> = CO<sub>2</sub> equivalent emissions in tons per month
- t = The time period (month)

**Computation of Technology Costs:** In computing the net present value of a technology, the costs of implementing the technology at a production complex are subtracted from benefits. In many

cases, the major cost associated with a strategy is the capital cost, which is the up-front cash investment required. The total capital cost is spread over the construction period with equal monthly installments. As noted in Table 5, the capital cost for implementing a technology at a new complex is typically less than retrofitting an existing complex with that new technology.

After the initial investment, there are often ongoing operating costs associated with the technology. The operation expenses are more applicable for gas capture options that involve installing new equipment that requires time and supplies for operation. In addition to operating costs, if a new strategy involves a type of technology that will require maintenance, there will be additional costs. Maintenance costs indicated in Table 5 were applied. The average monthly costs per each maintenance activity were based on the frequency of the maintenance activity (e.g., once a month or biannually).

**Net Cash Flow:** The next step in the complex-by-complex model is to derive the net cash flow by month as an aggregation of the monthly costs and benefits. After the net cash flow is derived, the cash flows are converted to NPV.

**Break-Even SC-CO<sub>2</sub>:** A break-even SC-CO<sub>2</sub> is computed for each combination of gas capture technology implementation at an applicable complex. This break-even SC-CO<sub>2</sub> is the social cost of carbon value that causes the operator’s investment to break even over the project lifetime (i.e., when the SC-CO<sub>2</sub> is at its break-even value, NPV = 0).

### **OCS-Wide Analysis of Technology Benefits and Costs**

After completing the evaluation of technology benefits and costs on a complex-by-complex basis, the Technology CBA Model aggregates costs and benefits of the different technology options and presents results for a range of scenarios.

**Technology Applicability:** For each scenario, technology benefits and costs are aggregated by complex structure type (Single Well, Fixed Leg, or Floating). This aggregation adjusts for the fact that some technologies are not applicable to all complexes by using an “applicability factor” that reflects the percent of complexes within a structure type for which the technology option is applicable. A baseline applicability factor was established for each technology based on a review of existing installed equipment identified in TIMS, along with expert judgment on the practicality of implementing technologies for different types of complexes.<sup>81</sup> In the absence of detailed designs for each complex, the analysts defined high and low applicability factors to evaluate and report results for a 80% confidence interval around the central estimate. Applicability factors listed in Table 7 are used in the Technology CBA Model. The “low” applicability represents the lowest percentage of complexes that the analysts were ninety percent confident the technology would apply to, and the “high” applicability represents the highest percentage of complexes the analysts were ninety percent confident the technology would apply to.

---

<sup>81</sup> For example, most single-well complexes do not have process equipment or compressors and are not manned, thus limiting the number of applicable technology options.

Table 7: Gas Capture Technology Applicability Factors.

Technology Option		Technology Applicability to Complex Type (%)									Basis of Applicability Specification
		SINGLE WELL			FIXED LEG			FLOATING			
		Base	Low	High	Base	Low	High	Base	Low	High	
1	Recover Gas from Pigging	0	0	0	40	10	50	90	30	100	Single well structures unlikely to have a pig trap; most floating structures have a pig trap and gas export line (reported 93%) as well as an LP compressor with capacity for this; Fixed structures with process equipment (reported ~ 50%) are likely to have a pig launcher, but may not have a compressor available. It is unlikely that any already have this technology.
2	Maintain Pressure in Standby Compressors	0	0	100	30	30	100	90	90	100	Single well structures unlikely to have compressors; 56% of fixed platforms and 98% of floaters have compression, but rarely does a fixed or floating facility have a fully operational, standby compressor (Assume 20% of those with compression).
3	Compressor Blowdown to Fuel Gas System	0	0	0	5	0	28	10	0	50	Single well structures unlikely to have compressor; fixed or floating platforms with compression (56% and 98% respectively) will have a fuel gas system also, so the technology could be used wherever compression exists.
4	Static Seals	0	0	0	55	56	56	98	98	100	Single well structures unlikely to have compressor; fixed or floating platforms with reciprocating compressor(s) (no data on compressor type available, so assume ~50% of 56% on fixed and ~10% of 98% on floaters are recip) could apply this technology.
5	Ejector	0	0	0	25	10	56	10	5	25	Single well structures unlikely to have compression; Fixed and floating structures with a high pressure system still available (parallel HP compression or separate Hp system) for motive gas while there is still an export path available and an IP or LP compressor available to recover the blowdown gas and motive gas. One major producer has about 50% of floating structures with parallel paths, but no fixed structures. Extrapolating to the GOM, assigned 40% to floating and 5% to fixed. This technology is rare offshore and where it is used is in continuous (not intermittent) service.
6	Capture Gas when Depressurizing Pipeline	0	0	0	5	0	10	40	0	50	Only 47% of fixed platforms and 15% of single well structures report having a gas export line, but nearly all floating structures have one. Assume that only 50% of those with a gas export line could accommodate equipment necessary for this technology, which industry has rarely employed for this purpose.

BSEE Venting and Flaring Research Study

7	Purge with Inert Gas	5	0	15	20	0	47	50	10	90	Only 47% of fixed platforms and 15% of single well structures report having a gas export line, but nearly all floating structures have one. Assume that only 50% of those with a gas export line could accommodate the temporary equipment necessary for this technology, which industry has rarely (if ever) employed for this purpose. This is nearly the same as the previous item, but requires more equipment.
8	Reduced Completions	5	0	15	20	0	47	50	10	90	Single well structures are unlikely to have compression to recover the gas vented from a new well unload. Only 56% of fixed (but nearly all floaters) have compression, so assume half of them would have active development.
9	Foaming Agents	0	0	10	25	0	40	50	10	80	Slightly more applicable than gas lift because compression is not required.
10	Velocity Tubing	10	5	15	15	5	60	10	0	30	Nearly the same applicability as for gas lift or foaming agents, but this requires a rig which may not be possible on the platform. Assume 50% of the candidates as for gas lift.
11	Flares	10	0	0	5	0	25	5	0	15	Single well structures are often unmanned and would not support a flare system; Most floating structures already have a flare; ~30% of fixed structures already have a flare per TIMS, but only 53% report vent. The number of structures that could accommodate a flare structurally may be limited, so assume only 20% could add flares.
12	Gas Lift System	0	0	0	20	0	35	0	0	0	Single well structures would not support gas lift; This technology assumes compression capacity is already available at sufficient pressure, which is the case on many fixed and floating oil producing structures. However, gas lift is already used on most wells that could benefit from it (oil wells on 74% of fixed and 90% of floaters), so the remaining opportunity is considered small.
13	Microturbines	0	0	0	10	5	50	10	5	30	Single well structure usually unmanned and would not support microturbines. Microturbines have only been installed in a few test applications offshore; however, floating structures are already equipped with surplus power generation and they have very limited weight and space. Fixed structures without flares (~ 50%) are more likely to accommodate smaller units (especially as older equipment requires upgrade/replacement), which require less recovered gas.
14	Electric Submersible Pump	0	0	0	25	0	50	10	0	20	Single well structures do not have sufficient power for ESPs. ESP's have been deployed in wells; however, many have been removed due to the costs of upkeep and upgrades to match the well flow changes. There are limited applications that can justify the costs, and those are primarily for recovery % improvement as opposed to emission reductions. The Pacific region uses more ESP's than the GOM partly because of the hardware challenges in deeper water. They are not applicable on subsea wells, which are more common on newer floating structures.

15	Jet Pump	0	0	0	10	5	30	5	0	20	Similar to available wells for gas lift.
16	Monitor Valves	0	0	6	60	30	78	70	35	88	Single well structures typically don't have automatic flare/vent control valves. Although applicable to all fixed structures and floating structures with processing equipment (88% and 98% reported to have process equipment), it is assumed that ~ 30% of structures already perform internal leakage checks and have repair programs and that the remaining 70% could apply this practice.
17	Redundant Compressor	0	0	0	2	0	25	25	10	50	Single well structures would not support compression; This technology is applicable on all structures with compression (56% fixed and 98% of floating); however, late life facilities and recently installed facilities probably already have redundant or partially redundant compression. One major has added compression on several floaters where space and weight was allocated in the initial design for future compression. Fixed structures are less likely to have power infrastructure and space for additional compression equipment.



**NPV Calculation:** The process for computing the aggregate net present value of benefits and costs for a particular technology can be demonstrated using an equation that sums benefits across time and complexes. Each considered technology is evaluated by means of benefit and cost functions represented inside the summation of the following equation.

$$NPV_A = \sum_{t=1}^{360} \sum_{s=1}^m c_{s,t} p_s [G_s + V_s - K_s - M_s - O_s] \left( \frac{1}{1+r} \right)^t$$

where:

- A = Gas capture technology alternative
- c = Complex
- s = Structure Type
- m = Number of structure types (i.e., 3 for single-well, fixed, and floating)
- t = The time period (month)
- p = Technology applicability percentage for the complex structure type
- r = The real discount rate
- G = Revenue from recovered gas
- V = Value of avoided emissions
- K = Technology capital cost
- M = Technology maintenance cost
- O = Technology operating cost

**Scenarios Evaluated:** Scenarios were defined to evaluate technology options across a range of possible future situations. Parameters that varied in the alternative scenarios include the applicable E&D scenario, price forecast for oil and gas, and SC-CO<sub>2</sub>. The base case and alternative scenarios evaluated in this CBA are described in Table 8.

**Table 8: Specifications for Scenarios Evaluated in CBA.**

Title	E&D Scenario	Social Cost (\$/tonne CO <sub>2e</sub> )	Oil and Gas Price Forecast
Base Case	Medium	11.97	EIA Long-term (low price)
Scenario 1	Low	11.97	EIA Long-term (low price)
Scenario 2	High	11.97	EIA Long-term (low price)
Scenario 3	Medium	11.97	Flat Real
Scenario 4	Medium	11.97	EIA Low Resource (high price)
Scenario 5	Medium	49	EIA Long-term (low price)

## CBA RESULTS BY COMPLEX

For each complex, conclusions are drawn with respect to which technologies are economic and under what circumstances (e.g., new floaters with 20 years of operating life).

### Technology Ranking by NPV for Individual Complex

A screen capture from the Technology CBA Model displayed in Table 9 presents results of implementing alternative gas capture technologies for a single complex. This information is for a new floating complex that begins operation in January 2019 and continues operation through the end of the study period, and uses the EIA Low Resource forecast of gas prices. Technology options are sorted from the most advantageous to the least, measured in terms of NPV. The main value drivers for the net present value are the amount of natural gas captured and emissions avoided relative to the capital expenditures. Technologies at the bottom of the table, with the worst economic performance, have high capital expenditures or low natural gas recovery – or both. For example, the ESP technology has a large negative NPV. This technology has an assumed capital cost of \$12 million and recovers 200 Mcf of natural gas per month. Because the electric submersible pumps also have operating and maintenance costs, under the base case assumptions, the value of gas captured and avoided emissions does not exceed the project costs – results in a negative NPV for this technology-complex combination.

### Contribution of Gas Revenue and Avoided Emissions to Technology Benefits

The Technology CBA Model also reports results of the individual complex analysis in graphical form. For example, Figure 23 presents the relative monetary value of the components of benefits associated with adding redundant compression technology to the new floating structure with complex identification number 993001. These benefits include (1) dollar amounts from sale of recovered natural gas at the projected natural gas price; (2) social value of avoided CO<sub>2</sub> emissions; and (3) social value of avoided CH<sub>4</sub> emissions.

**Table 9: Technology CBA Model Results for an Individual Complex.**

<b>Complex Number</b>	<b>993001</b>								
<b>Gas Production MSCF</b>	<b>796,311,151</b>	993001		Oil Price	Low Resource				
<b>FLOATER Complex/Ending</b>	<b>31-Dec-45</b>	993001 New Floater 2017		CO <sub>2</sub> Value/T	10.22				
	NPV	Cap Cost	Q Reduced	Methane	CO <sub>2</sub>	Equivalent	%	%	%
	\$	\$ 000's	MSCF/Mo	Reduction	Reduction	CO <sub>2</sub>	% Reduction	Reduction	CO <sub>2</sub> Equivalent
1 Reduced Emission Completions	2,995,601	200	10,000.00	439	29,564	40,549	9.34%	3.24%	6.18%
2 Install redundant compression	2,244,855	20,000	20,000.00	4,232	284,763	390,574	96.21%	33.14%	63.48%
3 Compressors Off - Maintain Pressure	608,886	15	312.29	86	5,770	7,914	1.78%	0.62%	1.18%
4 Compressor Static Seals	92,541	100	98.62	27	1,796	2,463	0.57%	0.20%	0.37%
5 Foaming agents to Remove Accumulated Fluid in Gas We	23,631	10	200.00	6	383	526	0.86%	0.32%	0.59%
6 Install Flares	-	-	0.00	-	-	-	0.00%	0.00%	0.00%
7 Using Pipeline Pump-Down Techniques to Lower Gas Lin	(27,267)	30	16.00	0	24	33	0.01%	0.00%	0.00%
8 Use Inert Gases and Pigs to Perform Pipeline Purges	(47,169)	50	16.00	0	24	33	0.01%	0.00%	0.00%
9 Compressors Off - Install ejector	(154,847)	200	30.00	8	535	734	0.17%	0.06%	0.11%
10 Gas Lift Well to remove liquid accumulation	(169,513)	210	200.00	6	383	526	0.83%	0.31%	0.57%
11 Monitor/repair leaking flare/vent control valves	(188,499)	-	292.20	80	5,399	7,405	1.66%	0.58%	1.10%
12 Compressors Off- Blowdown to fuel	(208,103)	215	2.60	1	47	65	0.01%	0.01%	0.01%
13 Reroute Gas Pig Trap Vent	(214,521)	200	2.74	1	47	65	0.02%	0.01%	0.01%
14 Microturbines	(4,452,154)	5,000	304.38	81	5,429	7,447	1.75%	0.60%	1.16%
15 Electric submersible pump (ESP) to unload wells	(13,451,235)	12,000	200.00	6	383	526	0.78%	0.29%	0.54%
16 Velocity tubing to Remove Accumulated Fluid in Gas We	(19,594,137)	20,000	200.00	6	383	526	0.80%	0.30%	0.55%

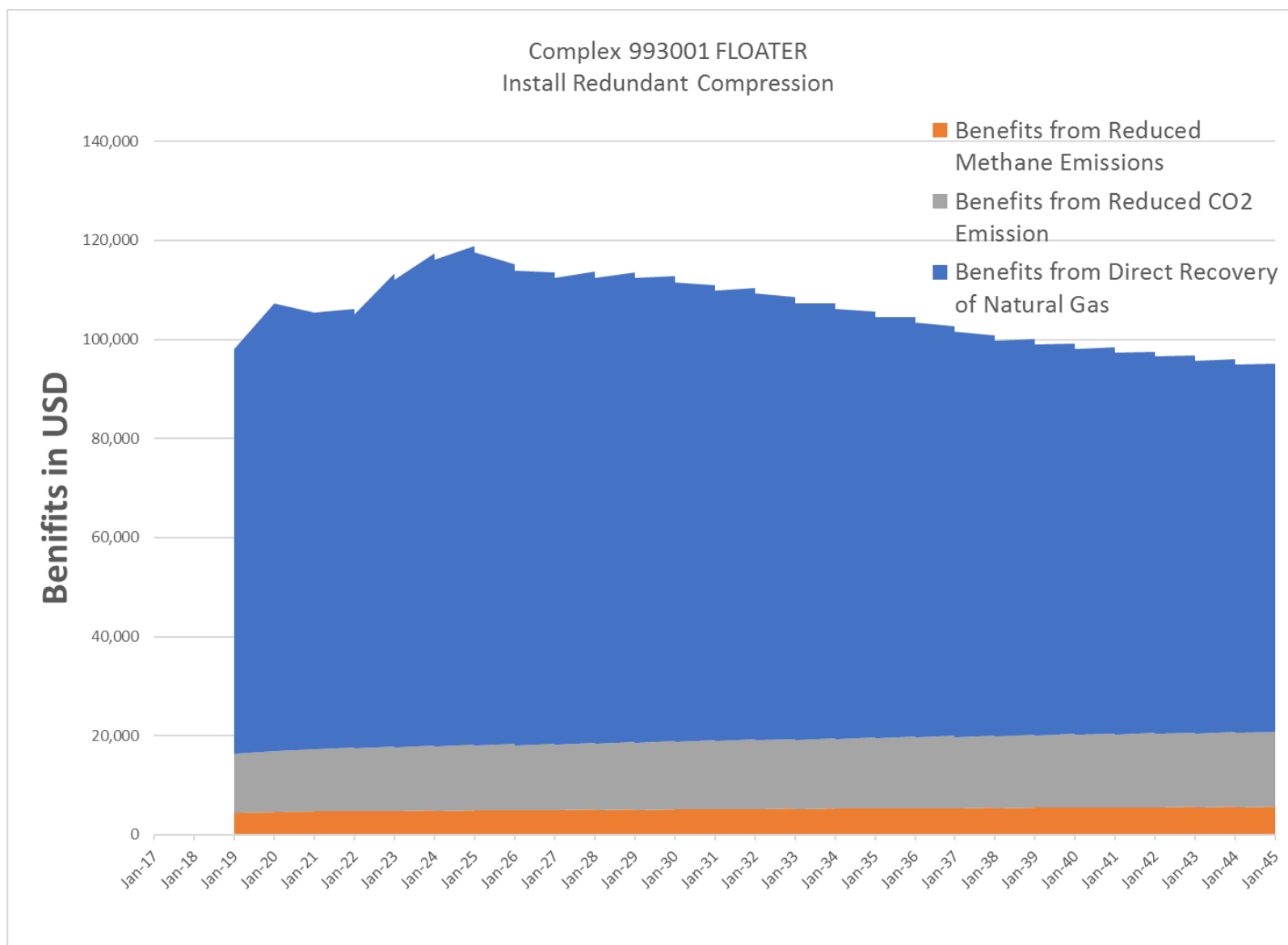

Figure 23: Quantification of Technology Benefits for Specific Floating Structure with Base Case Assumptions

### Identifying Cost-Beneficial Applications of Gas Capture Technologies

To identify situations in which it is cost-beneficial for technologies to be used in offshore operations, frequency distribution charts were prepared to display the number complexes having a common NPV outcome for a given technology. For example, the distribution chart in Figure 24 indicates that keeping systems pressurized during an extended compressor shutdown is cost-beneficial for nearly all existing and future complexes in the OCS – noting that fewer than 200 complexes have a negative NPV. Upon identifying which complex-technology combinations are (and are not) cost-beneficial, the research team reviewed specific complexes to determine the critical factors impacting cost-effectiveness. In the case of the “Maintain Pressure” technology options, complexes with a negative NPV were primarily those having a very short remaining operational lifetime at the start of the study.

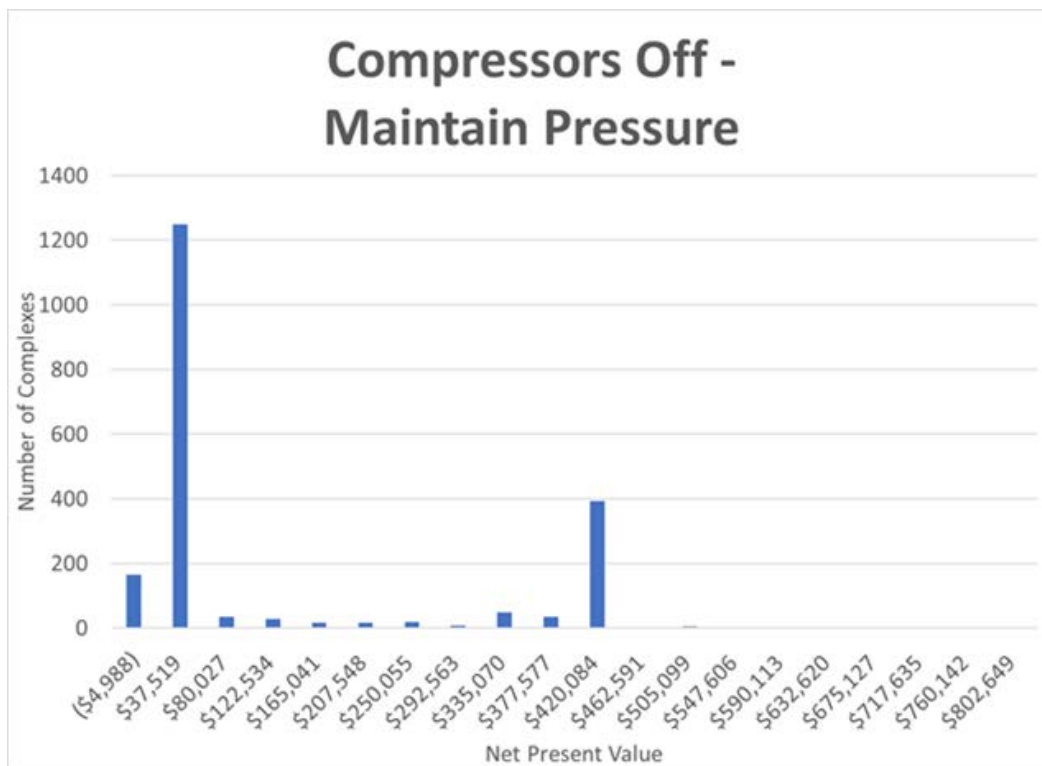

Figure 24: NPV Distribution by Complex for Compressor Off - Maintain Pressure Technology.

The frequency distribution chart for static seals technology is displayed in Figure 25.

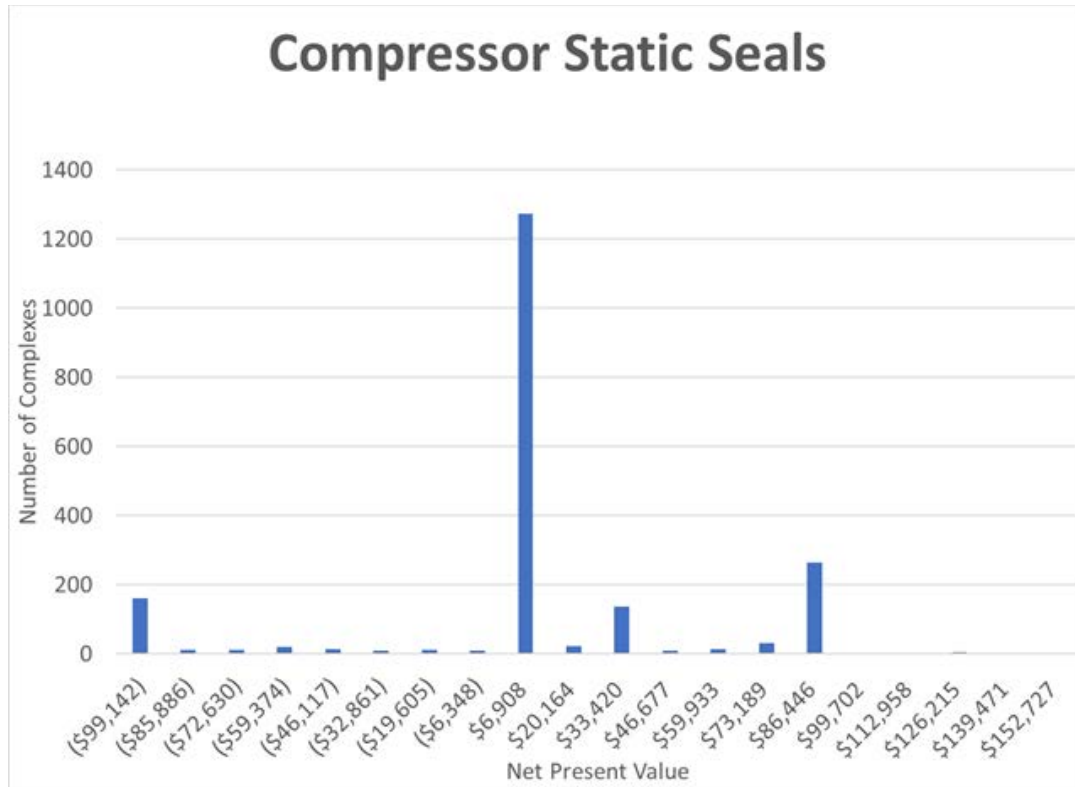

Figure 25: NPV Distribution by Complex for Static Seals Technology.

### Break-Even Social Cost of Carbon

In addition to computing the NPV for each technology, the break-even SC-CO<sub>2</sub> for each combination of technology and complex is computed. The break-even SC-CO<sub>2</sub> is the value per ton of reduced greenhouse gas emissions that would produce a NPV of zero for the technology. The break-even price can be negative if the value of the recovered gas exceeds the present value of capital and operating costs without any benefit attributable to the social value of emissions. For other technologies, the break-even price can be very high if the technology has relatively low levels of gas recovery, high capital and/or operating costs, or short operational lifetime.

After running the Technology CBA Model with base case assumptions and computing the break-even SC-CO<sub>2</sub> for each technology-complex combination, the minimum, average, and maximum values were calculated over the range of complexes. The resulting figures are presented in Table 7. It is worth noting that four technologies (numbers 2, 4, 8 and 9) have occurrences of negative break-even SC-CO<sub>2</sub>.

**Table 7: Break-Even Social Cost of Carbon by Technology with Base Case Assumptions.**

Technology Option		Break-Even Social Cost of Carbon (dollars per short ton CO <sub>2e</sub> )		
		Minimum	Average	Maximum
1	Recover Gas from Pigging	750	over 1000	over 1000
2	Maintain Pressure in Standby Compressors	(67)	(52)	257
3	Compressor Blowdown to Fuel Gas System	710	over 1000	over 1000
4	Static Seals	(35)	21	over 1000
5	Ejector	54	438	over 1000
6	Capture Gas when Depressurizing Pipeline	190	over 1000	over 1000
7	Purge with Inert Gas	323	over 1000	over 1000
8	Reduced Completions	(64)	477	over 1000
9	Foaming Agents	(43)	(15)	1000
10	Velocity Tubing	over 1000	over 1000	over 1000
11	Flares	32	over 1000	over 1000
12	Gas Lift System	54	416	over 1000
13	Microturbines	470	over 1000	over 1000
14	Electric Submersible Pump	over 1000	over 1000	over 1000
15	Jet Pump	over 1000	over 1000	over 1000
16	Monitor Valves	10	151	over 1000
17	Redundant Compressor	30	over 1000	over 1000

## AGGREGATED CBA RESULTS FOR OCS

This section presents the aggregate costs and benefits of applying different technology options to all applicable production facilities on the OCS and displays results of the different scenarios. The evaluation uses the applicability factors described earlier to account for technology options that apply to a subset of complexes. Finally, conclusions are drawn with respect to which technologies are economical and under what circumstances.

### OCS-Wide CBA Results for Base Case

Summary OCS-wide CBA results for the base case are presented in Table 8. The columns on the left side of the table list results obtained from applying each technology to all applicable complexes – irrespective of whether use of the technology is cost beneficial. Columns at the right of the table present results obtained from applying each technology to all applicable complexes only in situations where the associated benefits outweigh the costs; i.e., when NPV is positive.

**Table 8: Aggregate Technology CBA Results with Base Case Assumptions.**

Technology Option	Apply Technology to All Applicable Complexes				Apply Technology only when Cost Beneficial			
	Percent Reduction (short tons)			Sum of Positive and Negative NPV	Percent Reduction (short tons)			Sum of Positive NPV
	CH <sub>4</sub>	CO <sub>2</sub>	CO <sub>2e</sub>		CH <sub>4</sub>	CO <sub>2</sub>	CO <sub>2e</sub>	
1 Recover Gas from Pigging	0.07%	0.00%	0.04%	(46,683,273)	0.00%	0.00%	0.00%	0
2 Maintain Pressure in Standby Compressors	0.48%	0.57%	0.52%	7,730,263	0.48%	0.57%	0.52%	7,756,397
3 Compressor Blowdown to Fuel Gas System	0.08%	0.05%	0.07%	(52,476,549)	0.00%	0.00%	0.00%	0
4 Static Seals	0.99%	0.67%	0.86%	1,387,148	0.83%	0.62%	0.74%	4,760,648
5 Ejector	0.10%	0.10%	0.10%	(7,851,376)	0.00%	0.00%	0.00%	0
6 Capture Gas when Depressurizing Pipeline	0.02%	0.01%	0.01%	(3,890,056)	0.00%	0.00%	0.00%	0
7 Purge with Inert Gas	0.02%	0.01%	0.01%	(6,607,560)	0.00%	0.00%	0.00%	0
8 Reduced Completions	1.70%	4.87%	3.01%	29,596,761	1.35%	4.48%	2.65%	42,944,038
9 Foaming Agents	0.18%	0.16%	0.17%	1,219,350	0.17%	0.16%	0.16%	1,534,584
10 Velocity Tubing	0.08%	0.09%	0.08%	(1,005,294,579)	0.00%	0.00%	0.00%	0
11 Flares	1.67%	-0.26%	0.87%	(157,035,141)	0.00%	0.00%	0.00%	0
12 Gas Lift System	0.10%	0.08%	0.09%	(8,800,113)	0.00%	0.00%	0.00%	0
13 Microturbines	0.58%	2.22%	1.26%	(527,362,844)	0.00%	0.00%	0.00%	0
14 Electric Submersible Pump	0.09%	0.07%	0.08%	(603,237,546)	0.00%	0.00%	0.00%	0
15 Jet Pump	0.10%	0.08%	0.09%	(461,380,356)	0.00%	0.00%	0.00%	0
16 Monitor Valves	5.25%	5.61%	5.40%	(122,650,065)	1.19%	0.00%	0.70%	150,908
17 Redundant Compressor	5.12%	18.53%	10.67%	(489,062,965)	0.00%	0.00%	0.00%	0



## BSEE Venting and Flaring Research Study

Pollutant emission reductions are reported in terms of the percent of total OCS-wide emissions from venting and flaring over the period of study that could be avoided through application of the evaluated gas capture technology. For instance, use of reduced completions (technology 8) when cost-beneficial is estimated to avoid 1.35% of total CH<sub>4</sub> emissions and 4.48% of CO<sub>2</sub> emissions. In addition to reporting emission reductions in terms of avoided CH<sub>4</sub> and CO<sub>2</sub>, the GWP of CH<sub>4</sub> is used to compute an aggregated CO<sub>2e</sub> value. Note that installing flares (technology 11) reduces CH<sub>4</sub> emissions, while increasing CO<sub>2</sub> emissions as natural gas that would otherwise be vented to atmosphere is redirected for combustion with the installed flare.

Base case Technology CBA results in terms of avoided CO<sub>2e</sub> emissions across the OCS and over the study period are presented in Figure 26. The dashed vertical bar represents the range of possible CO<sub>2e</sub> reduction depending on the range of implementation actually achieved. As evidence of consistency in CBA model results, the five technologies having instances of positive NPV in the base case are displayed in Figure 26, noted in Table 7 as having a break-even SC-CO<sub>2</sub> that is less than the base case assumed value of 11.97 \$/tonne (10.22 \$/ton), and listed with a sum of positive NPV values greater than zero in Table 8.

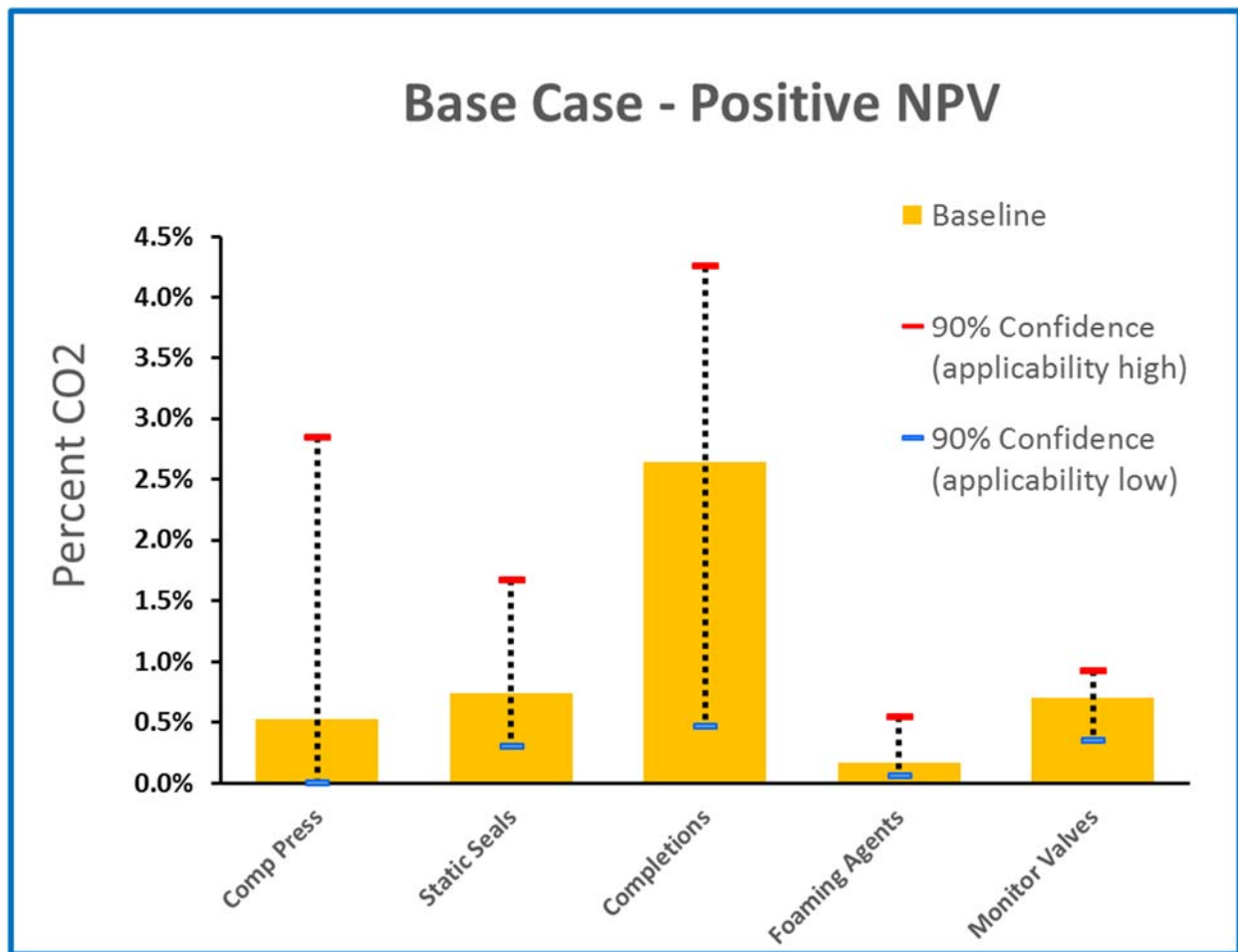

Figure 26: CO<sub>2</sub> Equivalent Avoided Emissions as Percent of OCS-Wide Total (Base Case).

## OCS-Wide CBA Results for Alternative Scenarios

In Table 9, results of the base case are compared with alternative scenarios in terms of aggregate avoided CO<sub>2e</sub> emission for technology-complex combinations with a positive NPV. The five technologies having instances of positive NPV in the base case have a similar effect in the Low E&D and High E&D production scenarios, while monitoring of valves (technology 16) does not appear to be cost-beneficial in the flat gas price scenario. The cumulated emission reduction potential of 4.77% in the base case, increases to 11.4% under the EIA high gas price assumption and to 13.4% with an assumed SC-CO<sub>2</sub> of \$49/tonne. This increase in emission reduction potential is primarily a result of cost-beneficial redundant compressor technology.

**Table 9: Avoided Emissions by Technology for Base Case and Alternative Scenarios.**

Technology Option		Avoided CO <sub>2e</sub> Emissions as Percent of OCS-wide Total					
		Base Case	S1: Low Production	S2: High Production	S3: Flat Gas Price	S4: High Gas Price	S5: SC-CO <sub>2</sub> \$49/tonne
<b>Total:</b>		<b>4.77%</b>	<b>4.81%</b>	<b>2.18%</b>	<b>3.80%</b>	<b>11.36%</b>	<b>13.42%</b>
1	Recover Gas from Pigging						
2	Maintain Pressure in Standby Compressors	0.52%	0.52%	0.19%	0.52%	0.52%	0.52%
3	Compressor Blowdown to Fuel Gas System						
4	Static Seals	0.74%	0.75%	0.24%	0.63%	0.78%	0.84%
5	Ejector						0.02%
6	Capture Gas when Depressurizing Pipeline						
7	Purge with Inert Gas						
8	Reduced Completions	2.65%	2.51%	1.44%	2.50%	2.73%	2.79%
9	Foaming Agents	0.16%	0.17%	0.07%	0.16%	0.16%	0.17%
10	Velocity Tubing						
11	Flares						0.18%
12	Gas Lift System						
13	Microturbines						
14	Electric Submersible Pump						
15	Jet Pump						
16	Monitor Valves	0.70%	0.85%	0.24%		1.05%	1.85%
17	Redundant Compressor					6.11%	7.05%

Results of five common cost-beneficial technologies across the base case and alternative scenarios are compared in the figures below.

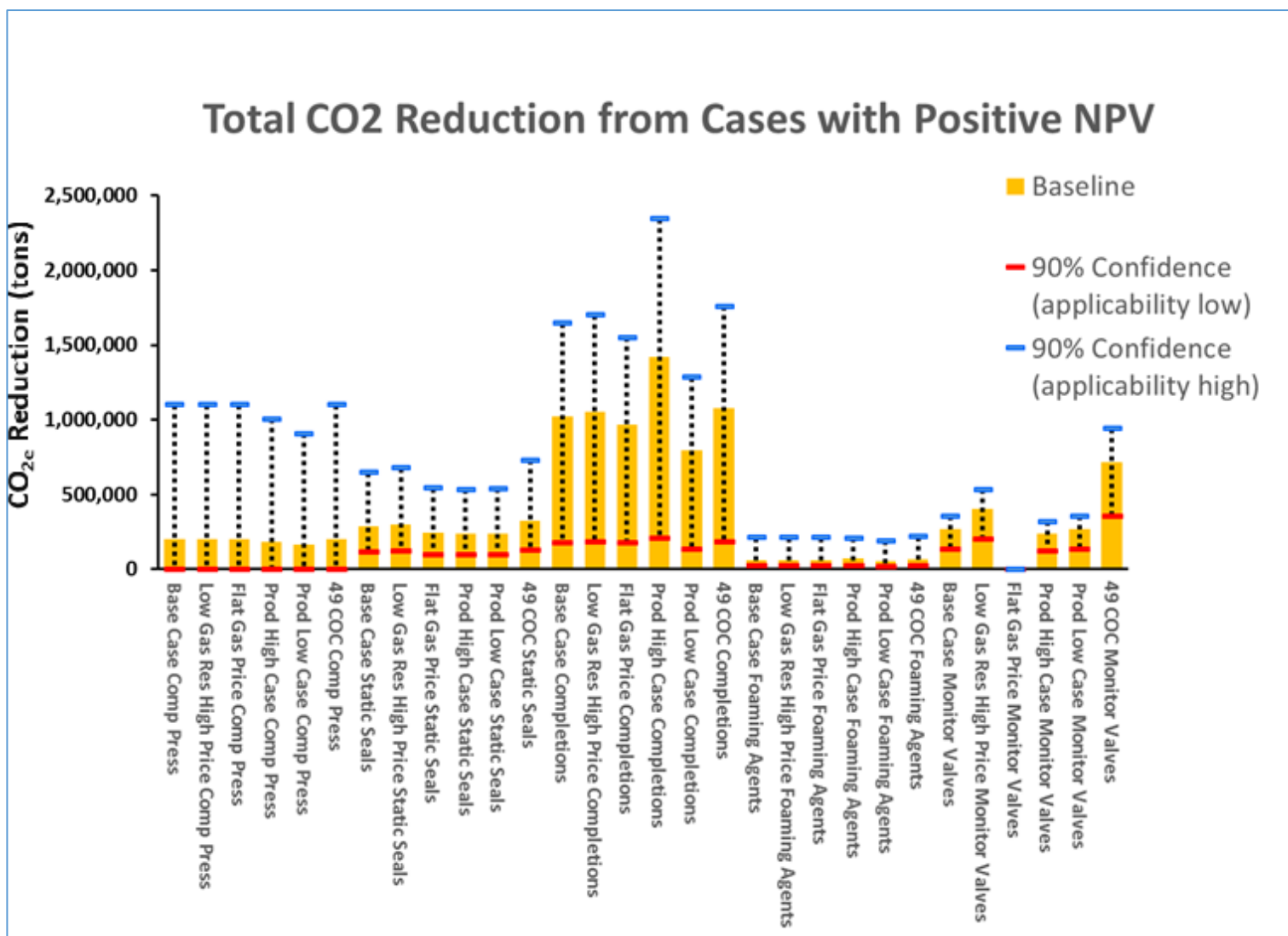

Figure 27: CO2 Equivalent Avoided Emissions (Base Case and Alternative Scenarios).

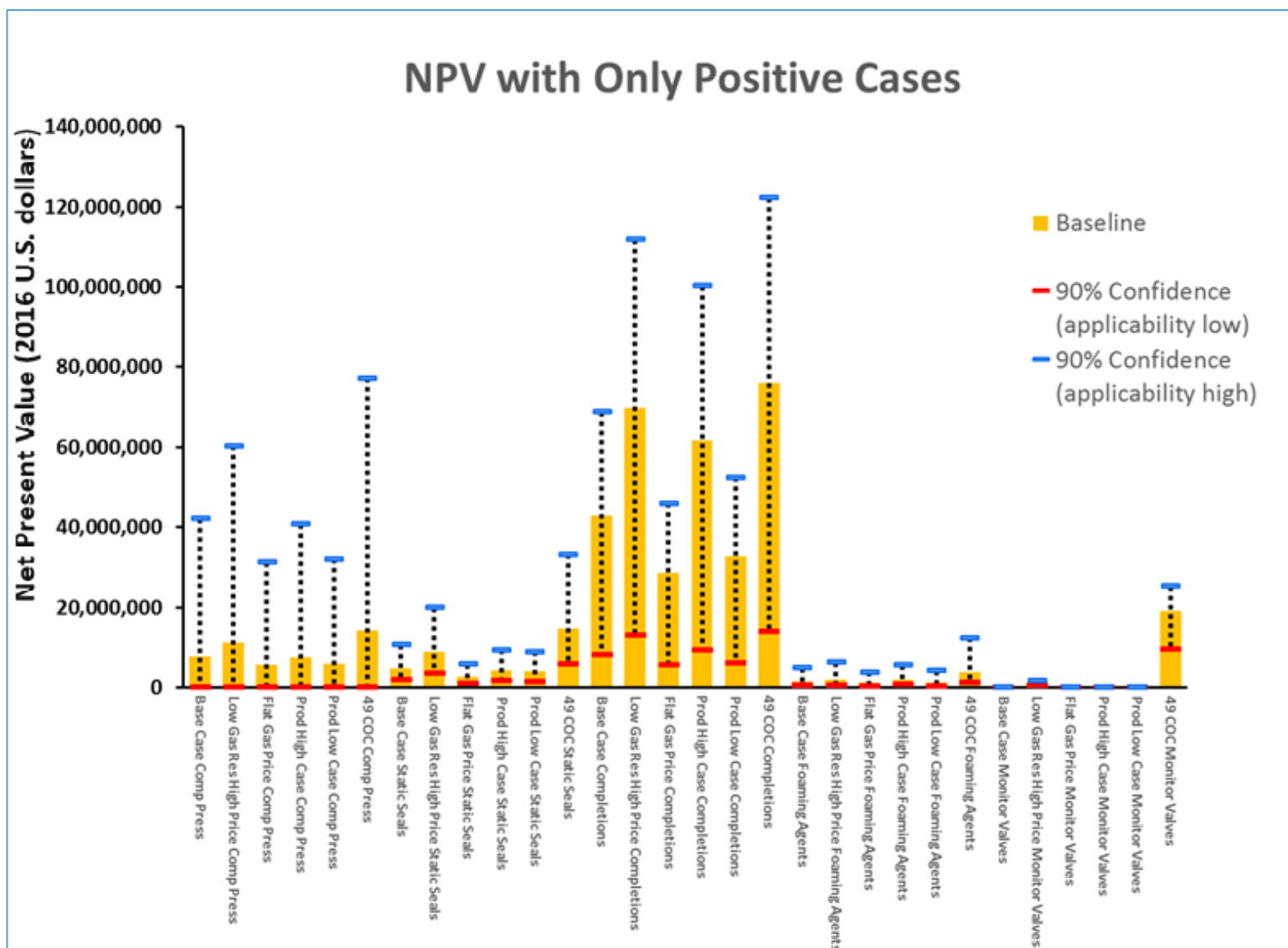

Figure 28: Total Value of Technologies with Positive NPVs (Base Case and Alternative Scenarios).

## Summary Observations from Technology Analysis

Five technologies are relatively inexpensive and provide emissions reductions as well as other benefits. While these technologies are already in use at a number of facilities, they have potential to be cost-beneficial at a significant number of additional complexes and provide cumulated emission reduction potential of 4.77% in the Base Case.

Reduced Completions was economic in about 30% of the complexes and most of those were new (became operational during the study period). The name “completions” is misleading as this opportunity is really about recovering the gas from temporary well flowback equipment. Fixed and Floating complexes that have LP compression and plan to perform well unloads on new wells or worked over wells could benefit from this technology. The CBA results indicate this technology is cost-beneficial under the Base Case and all evaluated scenarios, with a CO<sub>2e</sub> reduction potential of roughly 2.5%.

Maintain Pressure in Standby Compressors was economic for all complexes except those with less than one year life or having very limited venting or flaring volumes. However, it is mainly applicable when compressors will be offline for days/weeks and not isolated for maintenance. Offshore that could happen in rare cases when there is a spare compressor that stays in standby most of the time. Still, the CBA results point to this technology being cost-beneficial under the base case and all evaluated scenarios, with a CO<sub>2e</sub> reduction potential of approximately 0.5%.

Static Seals was economic in a large number of complexes, but even more limited than maintain pressure because it is applicable only in situations where there is a stand-by reciprocating compressor that will be left pressurized for long periods of time while not running. Model results indicate that static seals are cost-beneficial under the Base Case and all evaluated scenarios, with an estimated CO<sub>2e</sub> reduction potential ranging from 0.24 to 0.84%.

Foaming Agents are only applicable on late life direct vertical access gas wells that do not commingle fluids with oil wells because the foaming creates processing difficulties (emulsion) topsides where oil and water separation occurs. Model results estimate cost-beneficial application of foaming agents with a CO<sub>2e</sub> reduction potential of less than 0.2% for the base case and alternative scenarios.

Monitor Valves was economic in the base case and all evaluated scenarios except the Flat Gas Price scenario, with an estimated CO<sub>2e</sub> emission reduction potential ranging from 0.24 to 1.85%.

Redundant compressor technology is cost-beneficial in the High Gas Price and high SC-CO<sub>2</sub> scenarios. A total of eight technologies have instances of positive NPV with a SC-CO<sub>2</sub> of \$49/tonne. These include five technologies listed above and the following:

Redundant Compressor installation produces a larger reduction in emissions than any other technology option. By reducing the number of monthly flaring spikes due to compressor outage, this technology has an estimated CO<sub>2e</sub> reduction potential of over 6% in the High Gas Price scenario and more than 7% in the \$49/tonne SC-CO<sub>2</sub> scenario.

Ejectors and Flares were not economic at the domestic standard SC-CO<sub>2</sub>, but could be economic in limited applications in the High SC-CO<sub>2</sub> scenario.

## CONCLUSIONS AND RECOMMENDATIONS

### OBSERVATIONS

The most direct way for BSEE to limit venting and flaring emissions during natural gas production is to limit not only the circumstances during which venting and flaring can take place, but to also constrain the hours of an allowed event and ultimately cap the volume allowed during any event.<sup>82</sup> The effectiveness of such action would depend, as noted, on strong reporting (knowledge) of events, including duration and volume, and strong enforcement.

The efficacy of any regulatory system requires three things:

- Clarity in regulations, such that both the industry and the regulator have a common understanding of what is and is not required or expected for compliance.
- A strong inspection and enforcement system, which enforces the regulation and which is empowered to share the results of violations immediately or issue directives for corrective action.
- Knowledge of violations, industry trends, and operator performance. The finding of violations or potential violations and even the understanding of trends in the industry with respect to venting and flaring depend on the sharing of consistent and accurate data.

When considering regulatory changes, it is important to balance the need for certainty with the need for flexibility. In other words, it is easier to change regulations than statutes, and to change directives or guidance than regulations. While each of these carries decreasing weight in terms of certainty (where what is legislated is fixed until otherwise changed), each carries increasing weight in terms of responsiveness. Where technology is evolving or an industry is changing rapidly, it may be easier to change practice than to change regulation. BSEE's use of NTLs and BIDs provides an important vehicle for adapting to changing circumstances.

It is also important to consider the overall goal of minimizing the burden—in terms of cost and time—on both the regulators and the regulated. Resources on both sides are constrained, and an effective system will provide incentives for compliance not only through inspection, reporting, and data sharing, but also through making it as straightforward and simple to comply as possible. Inspectors and operators have a host of competing concerns, and addressing the venting and flaring of natural gas requires working within those constraints. Even when regulators implement firm overall targets concerning emissions or mandate the use of specific technologies, these

---

<sup>82</sup> Deep-water facilities can vent or flare huge volumes in a short period of time.



efforts are most successful when incentives are aligned for compliance. To that end, the research here has identified eight (8) potentially cost-effective technologies for consideration. While the NPV may depend on the specific type of facility, such recommendations come after exhaustive cost benefit analysis. The results enabled refining a list of technologies from the technically feasible to the economically feasible, and as a result, to what is feasible for a regulator to direct.

Perhaps most self-evident is the conclusion that it is much more cost effective to design and plan for limited venting and flaring during the design and construction of new structures. BSEE could look to develop new best practices in connection with industry experts to incorporate the technology options identified here into new structure design.

With respect to overall limitations on emissions, BSEE already has limits on venting and flaring, which are part of an established regulatory system that provides for enforcement through inspections and penalties. These regulations place limits on the duration of any venting or flaring event, but do not limit volumes of gas emitted during such events. The only volumetric limit is the one used to determine if an operator must consider the installation of a compressor (if volumes vented exceed 50 Mcf for an average event).

BSEE has not heretofore specified technology be used, as it would in the regulation of onsite emissions through the Clean Air Act. While it has mandated the use of certain technologies to bolster its inspection and reporting systems (i.e., the use of infrared cameras and meters), it has not mandated that facilities with specific characteristics install certain types of technology to limit emissions during venting and flaring events. Data on monthly venting and flaring volumes travels to BSEE from ONRR and comes in the form of lease- and well-based reports. This data must, in turn, be mapped to complexes. Improving the ease and accuracy of gathering data on venting and flaring includes addressing gaps in the reporting system, such as requiring mapping of well volumes to leases and complexes and taking advantage of electronic reporting and data collection to ensure volume data is shared quickly with those in BSEE who could identify and monitor trends. This may be a first step enabling BSEE to identify where the technologies Argonne has identified as cost effective can be most efficiently and economically placed into service.

The current data-sharing arrangement implicitly burdens the operator to determine what is cost effective to capture, without clear guidance on how that determination will be made by others. This delays BSEE from receiving information directly from its inspectors in a form that could be more easily acted upon. In particular, a framework for how cost effectiveness is determined could help BSEE identify areas where improved infrastructure may be needed or where opportunities to seek assistance for the development of new technologies might arise. In other words, if a consistent cost appears, BSEE could seek to work with other agencies to address the barrier to capture, including potentially working with others on the research, development, and implementation of new technologies, including those identified here as already cost-effective options.

The sharing of data can also be improved by requiring operators to immediately share event data with inspectors as well as royalty assessors. Given the natural challenges posed by onsite

inspections as facilities move further and further offshore, BSEE could direct operators to e-mail or upload event reports, which can be shared by other allowed personnel or other agencies. The goal here would be to facilitate preventive action and any need for enforcement action. BSEE could control and target its inspection system toward those facilities whose events appear to be larger or reflective of potential operational challenges before any violations might occur. BSEE could look to see if there are trends in the data showing challenges for particular types of facilities or operational practices that can be addressed through additional guidance.

In 2015, platform startups for deep-water floating structures accounted for roughly 15% of the total annual flaring volume on the OCS and an additional 20% of the annual total resulted from monthly spikes associated with compressor outage, pipeline maintenance, and well-unloading. It is not clear from the NTLs and BIDs how “trigger events”—which are not defined, but appear to be events for which allowance was sought either prospectively or retrospectively to venting and flaring in excess of existing limits—are reported and reviewed to look for trends in trigger events and opportunities for improvement.

The research shows the following general trends in the industry:

- First, the offshore industry is moving to floating structures as opposed to fixed structures. This, in turn, follows a trend in moving away from shallow water gas production to deep-water oil production (with floating structures and subsea wells).
- Second, while floating structures have a much higher flare volume than fixed or single-well structures, venting is more damaging than flaring to the environment. The industry trend toward floating structures may not by itself address venting from the fixed and single structures, which contribute most of the venting.
- Third, technology continues to evolve, and keeping up with changes and costs requires additional monitoring by regulators in order to assess what may or may not be designated as appropriate control technologies.
- Fourth, a large proportion of venting and flaring volumes is associated with monthly spikes, which, in turn, are event driven. Monthly spikes are primarily due to compression downtime, pipeline outages, and well unloading. Floating complexes (“floaters”) are the primary source of flaring events, while SW and fixed complexes account for the majority of venting events.

These underlying industry trends reveal themselves in the analysis of the most cost-beneficial ways to address venting and flaring. The majority of benefits from captured gas and avoided emissions come from new floaters applying redundant compression and reduced emission completions; with CO<sub>2</sub>e reduction potential of over 6% and 2.5% respectively. The next largest benefit is in applying monitoring and repairs to vent and flare valves at existing complexes. In comparing types of complexes, the majority of benefits come from new floaters and existing fixed structures. Most new floaters already plan to incorporate at least some of the technologies identified here. There is little applicability of the most cost-beneficial technologies to single well structures.

Specific to BSEE’s existing regulations, operators must request authorization from BSEE GOM in cases where they would like to exceed the limits of 48-hour continuous of 144 total hours of



flare or vent per month. Since the 2012 NTL, requests have been dramatically reduced. In an extreme case, the 144-hour monthly limit could allow up to 20% of monthly gas production to be vented or flared, since 144 is approximately 20% of the hours in a typical month. Based on reported flaring and venting and gas production volumes in OGOR-B, it appears that over 43 facilities (fixed and single-well structures) may have exceeded the allowable monthly venting limit — accounting for 14.4% of the 2015 annual venting volume for offshore operations. This observation points to the need for further BSEE investigation to determine whether the reported irregularities require correction of data entry errors or stronger enforcement.

The team’s research identified 17 gas capture technologies that appear applicable to offshore production. Only 5 are economic under base case conditions, and 8 have instances of positive NPV in sensitivity cases. Applying all 5 economic technologies to the entire fleet of applicable offshore complexes has potential to reduce equivalent CO<sub>2e</sub> emission by 9.2% from the baseline value. Applying technologies in cases where doing so is economical (i.e., has positive NPV) can reduce CO<sub>2e</sub> emission by 4.8% from the baseline.

## RECOMMENDATIONS

In response to these findings, industry trends, and a survey of gas capture technologies, the Argonne research team has the following recommendations:

1. Enforce compliance of existing regulations by monitoring facilities that exceed 144-hour venting and flaring limits. Have reporters to ONRR include the associated TIMS Complex ID when reporting monthly venting and flaring volumes on OGOR-B. To help ensure accurate data, BSEE should consider a broader application of vent and flare meters (e.g., where the past reported volumes show they could be measured) instead of strictly basing measurements on oil production rates. These meters could help provide continuous monitoring for flare and vent valve leakage that might otherwise continue until a periodic survey is done.
2. Establish new, reasonable monthly venting and flaring volume limits, while taking into consideration past performance and production (for example, those producing higher levels of oil and gas are likely to vent and flare more than lesser-producing complexes). Establish venting and flaring volume requirements for new structures and allow the operator to design facilities as necessary to meet them. Consider production rate and expected flare and vent potential volumes to set specific requirements for when flares are required. Following are some examples.
  - Each new platform with processing equipment or pigging facilities should have a flare unless a case is made that the pilot gas and purge gas emissions exceed the routine vent if there is no flare.
  - Each new platform should be designed without routine vent volumes by recovering the gas or flaring the gas that is traditionally expected to be routinely vented.

If not already done, BSEE should look to standardize how trigger events are reported by operators requesting authorization to exceed established limits. BSEE should also collect and review such reports to search for trends in trigger events and opportunities to engage with operators on how to minimize the occurrence of future events.

3. With respect to the technologies identified by this research as cost effective (reduced completions, redundant compressor, flares, maintain pressure in standby compressors, monitor valves, foaming agents, static seals, monitor valves), these can be implemented in a number of ways. BSEE could of course simply advise their use for any specific type of facility for which the given technology is cost effective. Such advice can be given through guidance documents. If BSEE concludes that such directives are too broad at this point, it could use a combination of facility type and performance to identify where technologies should be required. In other words, if a facility meets the characteristics for which a given technology solution is appropriate and cost effective and has either reached its regulatory maximum in terms of duration or exceeded it, BSEE could require only those facilities to implement that technology. BSEE could also investigate the use of such mandates as an alternative to instituting action after violations are found.

One exception may be where research calls for different techniques to be used versus the installation of specific technology. Several recommended technologies focus on the same opportunity: what can be done while the compressor is off (maintaining pressure, installation of ejectors, or blowdowns to fuel, and use of pipeline pump down techniques). Others focus on the same issue, such as the accumulation of fluid (use of foaming agents, gas lift wells, or velocity tubing). BSEE can issue guidance focused on the opportunity and issue, recommending operators address each instance through one of the recommended technologies.

For the situations where installation of technology is recommended (e.g., the use of compressor static seals or reduced emission completions), BSEE can issue guidance recommending these technologies be installed where the research shows it would be cost effective. One of the recommended technologies, the monitoring and repair of valves, should be fairly easy to implement. Since it can be integrated with ongoing maintenance and repair inspections, BSEE could simply add that issue to its ongoing inspection routines, require reporting on how often operators perform such maintenance, and issue guidance directing them to take steps to improve valve replacement.

One of the considerations is the length of time it would take to install, test, and finalize a cost-effective technology. BSEE could prioritize technologies that would be quickest to install for immediate deployment and adoption. For any of these steps, BSEE could issue guidance that requires time to implement based on how long it would be expected to deploy such technology. Operators need not be directed to comply within the same time frame for all recommended technologies, but could be given flexibility. Again, this is where consistent and accurate data reporting could help BSEE identify the most problematic areas requiring immediate attention, as well as those operators which appear to have an issue (for example, consistent monthly spikes in emissions from venting and flaring). Facilities could be categorized and prioritized for compliance based on the characteristics of the facility or average performance.

THIS REPORT WAS INADVERTENTLY DISSEMINATED IN THE PUBLIC DOMAIN/ONLINE SINCE 07/2021 WITHOUT A DISCLAIMER. DISCLAIMER HAS BEEN ADDED  
– “THIS INFORMATION IS DISTRIBUTED SOLELY FOR THE PURPOSE OF PEER REVIEW UNDER APPLICABLE INFORMATION QUALITY GUIDELINES. IT HAS NOT BEEN FORMALLY DISSEMINATED BY BSEE. IT DOES NOT REPRESENT AND SHOULD NOT BE CONSTRUED TO REPRESENT ANY AGENCY DETERMINATION OR POLICY.”

## APPENDIX I

# REGULATORY STATUS, DEVELOPMENTS, AND TRENDS REGARDING VENTING AND FLARING OF NATURAL GAS IN OIL AND GAS PRODUCTION

---

THIS REPORT WAS INADVERTENTLY DISSEMINATED IN THE PUBLIC DOMAIN/ONLINE SINCE 07/2021 WITHOUT A DISCLAIMER. DISCLAIMER HAS BEEN ADDED  
– “THIS INFORMATION IS DISTRIBUTED SOLELY FOR THE PURPOSE OF PEER REVIEW UNDER APPLICABLE INFORMATION QUALITY GUIDELINES. IT HAS NOT BEEN FORMALLY DISSEMINATED BY BSEE. IT DOES NOT REPRESENT AND SHOULD NOT BE CONSTRUED TO REPRESENT ANY AGENCY DETERMINATION OR POLICY.”



# Venting and Flaring Research

October | 2016

## Regulatory Status, Developments, and Trends Regarding Venting and Flaring of Natural Gas in Oil and Gas Production

### Final Report

Prepared by Argonne Venting and Flaring Research Team

*This page intentionally left blank.*

## Table of Contents

I.	Introduction.....	1
II.	Issue Background and Regulatory Challenges.....	2
III.	International Regulatory Best Practices .....	4
IV.	Regulatory Development in the United States.....	12

APPENDIX I Current Offshore Regulations Regarding the Venting and Flaring of Natural Gas

APPENDIX II Comparison of EPA and Department of the Interior Regulations as of 2011

APPENDIX III Comparison of BLM’s Proposed Rule to Existing Regulation and Rejected Alternatives

APPENDIX IV Comparison of United States Offshore and Onshore Regulations



THIS REPORT WAS INADVERTENTLY DISSEMINATED IN THE PUBLIC DOMAIN/ONLINE SINCE 07/2021 WITHOUT A DISCLAIMER. DISCLAIMER HAS BEEN ADDED  
– “THIS INFORMATION IS DISTRIBUTED SOLELY FOR THE PURPOSE OF PEER REVIEW UNDER APPLICABLE INFORMATION QUALITY GUIDELINES. IT HAS NOT BEEN FORMALLY DISSEMINATED BY BSEE. IT DOES NOT REPRESENT AND SHOULD NOT BE CONSTRUED TO REPRESENT ANY AGENCY DETERMINATION OR POLICY.”

## I. Introduction

In offshore operations, intentional venting and flaring impose costs both on the environment and on society. To support efforts to increase capture of intentionally vented and flared natural gas, the Bureau of Safety and Environmental Enforcement (BSEE) enlisted the assistance of Argonne to research, analyze, and report on how much gas is released, how much could be captured and marketed (or used), and under what situations it would be cost-beneficial to apply available technology and capture gas that would otherwise be intentionally vented and flared. As defined in the project Scope of Work, Argonne will:

1. Contrast BSEE’s current vent and flare regulations with those of comparable regulatory bodies (e.g., onshore and offshore oil and gas regulators both domestic and global);
2. Research technologies to capture gas that would otherwise be vented or flared;
3. Estimate the total volumes of vented and flared gas associated with oil and gas production in the Outer Continental Shelf (OCS); and
4. Conduct cost/benefit analyses of prospective vent and flare regulations.

Argonne’s research has yielded this report, the first in a series of research reports that will attempt to summarize trends and international regulations about the venting and flaring of natural gas. It is worth noting that, as of this writing, the Bureau of Land Management (BLM) and the Environmental Protection Agency (EPA) have proposed rules which would address venting and flaring. BLM has proposed revisions and additions to Title 43 of the Code of Federal Regulations (CFR) Parts 3100 (Onshore Oil and Gas Leasing) and 3600 (Onshore Oil and Gas). BLM has also proposed the additions of Parts 3178 (Royalty-Free Use of Lease Production) and 3179 (Waste Prevention and Resource Conservation). These requirements would impact those not affected by the EPA’s proposed revisions to its New Source Performance Standards (NSPS). Proposed subpart OOOO would govern the release of volatile organic compounds (VOCs) from new or existing sources in oil and gas production, and an additional subpart, OOOOa, would examine emissions from hydraulically fractured oil-well completions, pneumatic pumps, leaks, and other sources.

This report is organized into three parts:

1. Background information about venting and flaring and regulatory challenges;
2. An overview of best international regulatory practices developed by the World Bank Global Gas Flaring Reduction Partnership (GGFR); and
3. A summary of U.S. regulation to date.

The report’s appendices provide grounding for BLM and EPA proposed rules by comparing EPA and Department of the Interior regulations as of 2011. The appendices also list BLM’s proposed rules in comparison with existing regulations and rejected alternatives; compare United States offshore and onshore regulation; and detail the GGFR Implementation Plan for Canadian Regulatory Authorities.

## II. Background Information About Venting and Flaring and Regulatory Challenges

During regular oil and gas production, natural gas is burned and released into the atmosphere. The release of this gas is often necessary for a variety of operational reasons. This may happen when the primary purpose of drilling is to produce oil, when no local market exists for the gas, and when transporting the gas to a distant market is not economically feasible.<sup>1</sup> Natural gas prices are a major determinant of whether gas is flared and vented or sold, though recent technological advances in liquid natural gas infrastructure may expand opportunities for bringing gas to market. These advances may thus provide incentives for reducing instances of venting and flaring.

The processes of venting and flaring can be sorted into two categories of activity: continuous and intermittent. The latter category of intermittent flaring can be further divided into unplanned situations (for example, emergency situations) and planned situations (for example, maintenance and tests).<sup>2</sup> Intermittent venting may take place when operators purge water or hydrocarbon liquids collected in wellbores (liquid uploading) to maintain proper well function or when operators expel liquids and mud with pressurized natural gas after drilling.<sup>3</sup> Production equipment can also emit gas to maintain proper internal pressure, and in some cases, the release of pressurized gas itself is the power source for a piece of equipment (particularly in remote areas or areas such as offshore platforms that are not linked to an electrical grid<sup>4</sup>). This “operational” venting may involve the continuous releases of gas from pneumatic devices, such as valves that control gas flows, levels, temperatures, and pressures and that rely on pressurized gas for operation.<sup>5,6</sup>

The goal regulating intentional instances of venting and flaring depend on when and how the activity takes place. In the upstream oil and gas sector, the overall goal with respect to continuous events is to eliminate flares and vents through gas utilization projects. Intermittent events need to be addressed through improved operational practices that minimize the number

---

<sup>1</sup> General Accounting Office (GAO), *Natural Gas Flaring and Venting, Opportunities to Improve Data and Reduce Emissions*, GAO-04-809, July 2004, at 2.

<sup>2</sup> World Bank, Global Gas Flaring Reduction Partnership (GGFR), *Guidance on Upstream Flaring and Venting Policy and Regulation*, March 2009 (“GGFR Guidance”) at 9.

<sup>3</sup> GAO, *Federal Oil and Gas Leases, Opportunities Exist to Capture Vented and Flared Natural Gas Which Would Increase Royalty Payments and Reduce Greenhouse Gases*, GAO-11-34, October 2010, at 5.

<sup>4</sup> GAO-11-34 at 5.

<sup>5</sup> GAO-11-34 at 5.

<sup>6</sup> Intermittent venting also includes natural gas that vaporizes from oil condensate storage tanks or during the normal operation of natural gas that vaporizes from oil or condensate storage tanks or during the normal operation of natural gas dehydration equipment. GAO-11-34 at 5. Emissions may also come from leaks, resulting in unintended “fugitive” emissions.

and duration of events and resulting flare and vent volumes.<sup>7</sup> Further downstream (gas processing, liquid natural gas (LNG)) flaring and venting can similarly be reduced using improved operational practices.

Though gas losses from venting and flaring were at one time thought to be *de minimis* in comparison to the overall volumes of natural gas recovered and processed, advances in data collection (i.e., new reporting regulations) and the use of new technologies (e.g., infrared cameras) have revealed losses much greater than originally thought.<sup>8</sup> As a result, since 2004, the United States General Accounting Office (GAO) has been examining how to improve regulations and address instances of venting and flaring during natural gas production. (GAO reports show the progression of U.S. regulations and form the backdrop for the actions of the BSEE and BLM in recent years.)

Initially, GAO recommended regulatory changes called for improved reporting and oversight as well as exploration of the costs and benefits of requiring producers to flare rather than vent during standard operational procedures.<sup>9</sup> GAO also recommended the use of meters to measure amounts of gas flared and vented and the promotion of programs that would help industry leaders identify and implement best practices for controlling natural gas emissions (in particular, the EPA Natural Gas STAR program).<sup>10</sup> Finally, the GAO recommended examining market barriers that affect gas produced outside the United States, including any regulatory barriers to economically feasible infrastructure development.<sup>11</sup>

On land, the primary means of avoiding flaring is to capture, transport, and process gas for sale using the same technologies that are used for natural gas wells.<sup>12</sup> The capture and sale of gas depends on the availability of sufficient gas production, the costs, and the existing infrastructure.<sup>13</sup> In other words, if cost-effective to do so, facility operators would be expected to invest in capturing gas rather than flaring or venting it.

Recent increases in flaring occurrences have encouraged firms to develop new technologies and applications designed to capture smaller amounts of gas and use them productively where building a pipeline to market is impractical.<sup>14</sup> These technologies and applications include separating out natural gas liquids (NGLs), using gas to run microturbines to generate power; and

---

<sup>7</sup> GGFR Guidance at 9.

<sup>8</sup> GAO-11-34 at 5-6.

<sup>9</sup> GAO-04-809 at 7.

<sup>10</sup> GAO-04-809 at 20.

<sup>11</sup> *Id.*

<sup>12</sup> BLM, *Regulatory Impact Analysis for Revisions to 43 CFR § 3100, 3600 and Addition of § 3178 and 3179*, Jan. 2016 (“Reg. Impact Analysis”) at 46.

<sup>13</sup> *Id.*

<sup>14</sup> Reb. Impact Analysis at 46-47.

## BSEE Venting and Flaring Research

---

using small integrated gas compressors to convert gas into compressed natural gas (CNG) for transportation or conversion to chemicals.<sup>15</sup>

Microturbines can make use of gas if paired with NGL recovery, as the NGL residue gas stream is well suited as fuel for generators.<sup>16</sup> However, scaling gas to what can be used at the place of production is difficult –excess gas may not be saleable, and if sold, may be considered by a regulators as “not beneficial use” and as result, not be royalty free.<sup>17</sup> CNG shows promise by effectively transporting gas to a centrally located processing plant and by removing higher-value NGLs for other productive uses.<sup>18</sup> However, limitations on the amount and rate of capture and compression reduce the applicability of this technology, even though technology changes might increase the range of sites where using microturbines might be a good option for making use of gas that otherwise could be vented or flared.<sup>19</sup> Facilities that condense natural gas into LNG may be more cost-effective at onshore locations with large amounts of flaring.<sup>20</sup>

### III. International Regulatory Best Practices

Among the leading international authorities on best practices for regulating venting and flaring are the World Bank and its Global Gas Flaring Reduction (GGFR) Partnership. The GGFR noted that worldwide practices on regulating venting and flaring vary widely. Therefore, the GGFR developed minimum criteria to ensure transparent and efficient regulation, including;

- Independence of institutions that regulate gas flaring and venting from the companies they regulate;
- Clearly defined regulatory responsibilities for regulatory agencies;
- Transparent and enforceable regulatory procedures and operational processes;
- No conflicting or overlapping responsibilities among regulating institutions; and
- Ability to enforce compliance by being properly staffed and financed.<sup>21</sup>

---

<sup>15</sup> Reg. Impact Analysis at 47.

<sup>16</sup> *Id.*

<sup>17</sup> *Id.*

<sup>18</sup> Reg. Impact Analysis at 48.

<sup>19</sup> *Id.*

<sup>20</sup> *Id.*

<sup>21</sup> GGFR, *Regulation of Associated Gas Flaring and Venting – A Global Overview and Lessons*, No. 29554, July 2004 (“GGFR Global Overview”) at 8.

### *2004 Survey of Existing Practices*<sup>22</sup>

In 2004, the GGFR conducted a survey of existing practices for regulating venting and flaring. While the surveyed yielded no international best practice or generally accepted theory about who should regulate gas flaring and venting, most surveyed countries used either prescriptive or performance-based regulation.<sup>23</sup> A prescriptive regulatory regime uses specific and detailed regulations that give clear directions on regulatory processes and procedures, set expectations of operators, and provide incentives for compliance through strict enforcement.<sup>24</sup> In theory, this approach makes it relatively easy for regulators to set targets and determine whether operators are meeting requirements.<sup>25</sup> In practice, however, for a regulatory authority, imposing detailed technical regulations is a challenging and complicated undertaking, and monitoring compliance on each site could be impractical and costly.<sup>26</sup>

Consequently, most countries surveyed by GGFR opted for a more performance-based approach to flaring and venting reductions.<sup>27</sup> While it still requires strict enforcement to be effective, this approach places greater emphasis on consensus and cooperation between the industry and the regulator in setting objectives and targets for gas flaring and venting.<sup>28</sup> It is then the responsibility of the operator to define strategies for achieving these targets and provide evidence demonstrating it is complying with the agreement.<sup>29</sup>

Irrespective of the approach adopted, to establish an efficient and effective regulatory regime for gas flaring and venting, GGFR recommended that regulators focus on two key areas: operational processes and regulatory procedures.<sup>30</sup>

***Operational Processes:*** Noting that flaring and venting are important safety measures, the GGFR looked at whether specific operational standards that ensure environmental health and safety are being met when operators flare and vent associated gas. While these practices may be subject to a variety of conditions, operational standards and guidelines typically address the following issues:

---

<sup>22</sup> The GGFR report included analytical profiles of 44 countries compiled by the World Bank research team and described in the report.

<sup>23</sup> GGFR Global Overview at 8.

<sup>24</sup> *Id.*

<sup>25</sup> *Id.*

<sup>26</sup> *Id.*

<sup>27</sup> *Id.*

<sup>28</sup> *Id.*

<sup>29</sup> *Id.*

<sup>30</sup> GGFR Global Overview at 9.

## BSEE Venting and Flaring Research

---

- How gas is “burned” or “burn technologies and practices” and where equipment and operating processes may be specified to ensure burning of “clean” gas and efficient combustion;
- Timing of instances, where the maximum duration of continuous flaring may be limited;
- Flare locations (a safe distance from other facilities), accommodation units, and populated areas; ·
- Heat and noise generation from flaring, including upper limits set at specified distances from flaring operations; and
- Smoke and noxious odor limitations, which may be imposed on the opacity of smoke generated by flaring and noxious odors.<sup>31</sup>

**Regulatory Procedures:** In general, regulatory procedures focus on the approval of applications to flare and vent. They also focus on measuring and reporting events where gas is flared and vented.<sup>32</sup> Regulatory procedures encompass the following areas:

- **Approval of Venting and Flaring:** Noting that many countries allowed flaring and venting for safety or unavoidable technical reasons, or during emergencies, the GGFR concluded that the grounds for venting and flaring to be permissible were often vaguely identified. Only a few countries had clearly defined circumstances and events which would allow permissible flaring and venting without prior approval.<sup>33</sup> The GGFR recommended that the circumstances under which operators can flare and vent associated gas without prior approval from the relevant regulatory authority be clearly defined in regulation.<sup>34</sup>

Where preapproval was sought, the GGFR observed that application and approval procedures could take place in a number of different ways (as part of an overall field development approval or as a separate permit or environmental license). Before approving flaring and venting volumes, regulatory agencies often required operators to provide evidence about the likely impact that flaring and venting would have on the environment. This evidence was acquired through an environmental impact assessment (EIA) that had to be submitted as part of the flare permit or field development application process.<sup>35</sup>

As part of the approval procedure, the GGFR noted that regulators, before issuing authorizations, were increasing their examination of the economics involved, requiring operators to prove that it is uneconomical for them to avoid venting or flaring.<sup>36</sup> Some jurisdictions made it mandatory that operators prove they had investigated all reasonable

---

<sup>31</sup> GGFR Global Overview at 9-10.

<sup>32</sup> GGFR Global Overview at 11 (noting the value of having regulatory procedures made public to achieve openness and transparency goals).

<sup>33</sup> GGFR Global Overview at 11-12 (noting the decision was often left to the discretion of operators with reference to good oil field engineering practices and utilization principles).

<sup>34</sup> *Id.*

<sup>35</sup> GGFR Global Overview at 12-13.

<sup>36</sup> GGFR Global Overview at 13.



alternatives to flaring and venting, including use of captured gas (e.g., to reinject into producing oil columns for improved oil recovery), and sale of captured gas in downstream energy markets.<sup>37</sup> One trend was that regulators were adopting an “incremental” approach in which they were allowing operators to flare or vent only if the operators could prove that the incremental benefits of not venting or flaring were lower than the incremental costs.<sup>38</sup> Under this approach, flaring and venting of gas was considered a negative externality of oil production, and the costs of that externality had to be fully included in assessing the net benefit of the oil production in a field.<sup>39</sup> Concluding that this approach helped reduce gas flaring and venting compared with an incremental approach, the GGFR noted it also increased the costs of developing an oil field.<sup>40</sup>

- Measuring and Reporting: The GGFR believed the main objective of measurement and reporting regulations was to ensure accurate information and data about flaring and venting volumes. These aspects were monitored via two options – direct measurement through metering, and estimation. Noting that metering had been contentious because of the costs and practical consideration of operating conditions, the GGFR identified trends in ultrasonic metering, which was already being widely used in the North Sea and would improve metering accuracy.<sup>41</sup> Many regulators surveyed required operators to report flared and vented volumes accurately and allowed operators to decide whether to install meters (and the type of meter to install) or to provide estimates. Some regulators required meter installations only for certain hazardous types of flaring and venting or if certain volume thresholds were exceeded.<sup>42</sup> All estimates were required to be based on engineering calculations, procedures, and software packages that had been widely tested and approved. In many countries, operators were required to maintain flaring and venting registers that were subject to audit and to report those data to the regulatory authority on a regular basis.<sup>43</sup>

According to the GGFR’s survey, most regulators acknowledged that operating processes and regulatory procedures were not effective without adequate monitoring and enforcement powers in cases of noncompliance.<sup>44</sup> Because technical and financial restrictions limit the monitoring of all flaring and venting sites, the GGFR noted that site inspections form an integral part of more advanced—and more aggressive—regulatory regimes.<sup>45</sup> The GGFR considered the potential costs and the requirements of qualified personnel to carry out such site visits. They noted that

---

<sup>37</sup> *Id.*

<sup>38</sup> *Id.*

<sup>39</sup> GGFR Global Overview at 14.

<sup>40</sup> *Id.*

<sup>41</sup> GGFR Global Overview at 16.

<sup>42</sup> *Id.*

<sup>43</sup> *Id.*

<sup>44</sup> GGFR Global Overview at 17.

<sup>45</sup> *Id.*



## BSEE Venting and Flaring Research

---

monitoring has been applied mostly in industrial-country jurisdictions where regulators have developed methods and criteria that preselect installation sites most likely to require close regulatory scrutiny.<sup>46</sup> Where violations were found, many regulators imposed sanctions (enforcement actions) on operators. These took the forms of penalties, fines, or withdrawal of a production/operation license.<sup>47</sup>

### *International Regulatory Response/Recommendations*

In response to its survey of existing practices, the GGFR concluded that most investments in gas utilization were funded by oil companies that were unlikely to commit resources to gas utilization projects. Thus, the GGFR recommended that governments create an environment that supports company economic viability and make clear the rights and obligations of oil companies to avoid venting and flaring.<sup>48</sup> The GGFR expressed that government commitment to reducing venting and flaring, through a strong regulatory regime, is critical.<sup>49</sup>

The GGFR encouraged governments to understand industry drivers and tradeoffs and to ensure that all aspects of production—upstream and downstream—be addressed in setting regulatory policy. Aspects to consider included challenges to infrastructure development, pricing and national strategies for production, and emissions reductions.<sup>50</sup> The GGFR argued that, as with any regulatory regime, to be effective, regulators need a clear mandate translated into transparent and enforceable regulations, adequate staff, and financial resources. Industry consultation was also seen as important for ensuring that flaring and venting targets are feasible, that regulations are realistic, and that emphasis is placed on encouraging operators to utilize gas economically.<sup>51</sup> The GGFR also stated that accurate measurement and reporting of flared volumes is necessary if enforcement is to be effective, and that access to reliable and consistent data is critical to identifying intervention needs, trends, and increases.<sup>52</sup> Finally, the GGFR concluded that penalties could be useful, but that threats to suspend or withdraw licenses for flaring may not be credible.<sup>53</sup>

---

<sup>46</sup> *Id.*

<sup>47</sup> GGFR Global Overview at 18.

<sup>48</sup> GGFR, *Guidance on Upstream Flaring and Venting Policy and Regulation*, March 2009 (“GGFR Guidance”) at 1.

<sup>49</sup> GGFR, *International Practices in Policy and Regulation of Flaring and Venting in Upstream Operations – Lessons from International Experience*, GGFR SCM Workshop, Dec. 2011 (“GGFR SCM Workshop”). {This seems redundant to what was already in the main text of the report.} *See* World Bank Policy Research Working Paper on regulatory effectiveness (WPS 3536, 2005). {Is there anything that human beings do that should not have this?} KM: Lots of things actually in a regulatory and legal context. Agree we can lose this but the fact is there are certainly regulatory areas I would say don’t have all these characteristics, desirable as they may be. Notes need for independence. GGFR Guidance at 8.

<sup>50</sup> GGFR SCM Workshop, Dec. 2011.

<sup>51</sup> *Id.*

<sup>52</sup> *Id.* (noting data could be made public as well if appropriate).

<sup>53</sup> *Id.*

In order to support these recommendations, the GGFR advised that successful regimes should have the following characteristics:

- Legislation should be clear, comprehensive, and unambiguous in its treatment of gas.<sup>54</sup>
- Incentives and penalties should create a situation where the economically preferred method of handling gas production is through utilization.<sup>55</sup> Penalties could be assessed for gas which could have been utilized or was flared or vented without approval. These penalties should be high enough to make investment attractive, but not high enough to force closing production.<sup>56</sup>
- The gas market should encourage gas utilization by supporting: the right to monetize gas, generally including gas export; open and nondiscriminatory access to infrastructure, gas processing and transmission facilities, and electric grids; and market-based energy pricing.<sup>57</sup>
- Effective monitoring and enforcement should reinforce market conditions and investment incentive schemes and encourage operators to consider every gas utilization option.<sup>58</sup> Measurement can be technically challenging due to a variety of factors (such as the potentially large volume changes over a short time period, low gas pressure, and the presence in gas of liquids and sometime solids). However, metering equipment (e.g., ultrasonic meters) can be used to meet these challenges.<sup>59</sup> The use of such equipment should be properly justified because of the high cost,<sup>60</sup> and selection of the most appropriate method will usually depend on the accuracy required, the volume of flared gas to be measured and the degree of variability, the liquid content of the gas, and the availability of a specific meter type and associated support infrastructure.<sup>61</sup> Operators can be required to keep records of all flare/vent events and report these records to the regulator on a regular basis.<sup>62</sup> Ad-hoc site inspections can then be used to make sure records are being kept, ensure appropriate gas measuring equipment is installed, and check on methodologies used to estimate flare/vent volumes.<sup>63</sup>
- A strong reporting regime can monitor operators' compliance with approved flaring and venting levels. This regime can identify underperforming sites (e.g., by comparing the

---

<sup>54</sup> GGFR Guidance at 1.

<sup>55</sup> *Id.*

<sup>56</sup> GGFR Guidance at 7.

<sup>57</sup> GGFR Guidance at 1.

<sup>58</sup> *Id.*

<sup>59</sup> GGFR Guidance at 10.

<sup>60</sup> In Alberta (Canada), for low volumes of flaring and venting, the operator may estimate the volumes using technically sound procedures rather than meter the flows. GGFR Guidance at 10.

<sup>61</sup> GGFR, *Guidelines on Flare and Vent Measurement*, BOEMRE Workshop, March 2011, at 13.

<sup>62</sup> GGFR Guidance at 12.

<sup>63</sup> *Id.* (noting onsite inspections can be challenging since vented gas is not visible to the naked eye).

## BSEE Venting and Flaring Research

---

performance of similar types of sites), identify sites warranting a site inspection, and monitor progress in flare and vent reduction within a jurisdiction. The choice of reporting method ultimately depends on the number of sites and a regulator’s capacity to regularly monitor performance and check compliance.<sup>64</sup> Reports on all events should be required, regardless of the size of the event, and they should distinguish between continuous and intermittent events. Such reports should include data on oil production, gas production, and gas utilization.<sup>65</sup> Daily logs can be maintained, reported at least on a monthly basis, and retained for “a few” years.<sup>66</sup> Ad-hoc site inspections can then make sure that records are being kept and that appropriate gas measuring equipment is installed, and that adequate methodologies are being used to estimate flare/vent volumes.<sup>67</sup>

- Through stakeholder consultations, comprehensive and methodical approaches can be developed to address venting and flaring. This can be done by creating an environment that encourages gas utilization investments, establishing a realistic schedule of required action for flare/vent reductions, coordination of operators’ investment programs, and close monitoring of programs to ensure they are implemented on time.<sup>68</sup>
- Provisions for gas utilization are an integral part of the field planning process for new oil developments.<sup>69</sup> It is essential that regulators ensure that the available gas infrastructure (gas processing facilities and pipelines, for example) can be used by an operator even when gas facilities are owned by a third party.<sup>70</sup> Open and fair third-party access to gas gathering, processing, and transmission facilities is critical to promoting gas utilization. As such, any regulatory regime would need to assure nondiscriminatory and transparent access to the gas handling infrastructure, including gas processing facilities, gas pipelines, and trunk lines.<sup>71</sup> Another good practice is to request that an operator evaluate opportunities of joint gas utilization projects with neighboring operators or provide gas

---

<sup>64</sup> GGFR Guidance at 12-13.

<sup>65</sup> GGFR Guidance at 13.

<sup>66</sup> If the emission of greenhouse gases is a concern, this reporting regime should be integrated into whatever existing reporting system for the upstream hydrocarbon sector is used. GGFR Guidance at 13. Additional information that will be needed includes the volume of gas flared or vented, the gas composition or average flared/vented gas density; and the flare combustion efficiency. *Id.*

<sup>67</sup> *Id.*

<sup>68</sup> GGFR Guidance at 1-2.

<sup>69</sup> GGFR Guidance at 2.

<sup>70</sup> GGFR Guidance at 11.

<sup>71</sup> GGFR Guidance at 14-15. Upstream gas infrastructure is usually built and owned by operators, and as a result, access is often not regulated and therefore entails commercial negotiations between the parties. GGFR at 14. It is good practice, however, for the regulator to have the right to impose third party access if this cannot be secured through commercial negotiations. GGFR at 14-15. Downstream gas infrastructure is often owned by utility companies which, in many cases, are regulated to ensure tariffs etc. are set fairly, and that access is free and open to all potential users provided gas quality specifications are met. *Id.*

free of charge at the license boundary to any interested party.<sup>72</sup> Regimes using an economic framework can be regularly reviewed and updated (for example, every 12 months), and the framework should specify baselines for each economic criterion, including rules for net present value (NPV) calculation (pre-tax or after-tax cash flows); discount rates and uses; operating costs and estimating guidelines (e.g., as a percentage of capital expenditures); standard rates to be used for CAPEX items; price forecasts for commodities which can be produced from associated gas; inflation assumptions; and the gas processing and pipeline tariffs to be used.

- A plan for gas utilization should be integrated into a country gas master plan or energy sector strategy.<sup>73</sup>

According to the GGFR, addressing flaring and venting is more effective and less expensive if it is done during field development planning.<sup>74</sup> This is true both onshore and offshore, but in particular for the latter due to the typical lack of space on an offshore platform to retro-fit additional (gas utilization) equipment.<sup>75</sup> In view of this, it is good practice for the regulator to require all operators to develop gas utilization options during the design phase and to incorporate appropriate gas utilization facilities during construction.<sup>76</sup>

Any approach that requires regulators’ prior approval to flare or vent for each installation may be practical when there is a small number of installations but may be impractical when the number gets much larger.<sup>77</sup> Where large numbers of installations are present, operators should be required to invest in a gas utilization project where the net present value of the project is above an industry-wide threshold established by the regulator.<sup>78</sup> Where there are a manageable number of installations, the regulator may request the operator seek approval for venting or flaring activity if the duration of an event exceeds a certain threshold.<sup>79</sup>

Finally, the GGFR recommends the annual reporting of flare and vent volumes to provide a clear measure of progress in flaring and venting reduction and create positive pressure for continuous improvement.<sup>80</sup>

---

<sup>72</sup> GGFR Guidance at 11.

<sup>73</sup> GGFR Guidance at 2.

<sup>74</sup> GGFR Guidance at 9.

<sup>75</sup> *Id.*

<sup>76</sup> *Id.*

<sup>77</sup> GGFR Guidance at 10.

<sup>78</sup> *Id.*

<sup>79</sup> Another option is to set up a volume-based threshold (such as in Alaska, where operators must seek approval for flaring/venting volumes that will exceed 1 million standard cubic feet per day). GGFR Guidance at 10.

<sup>80</sup> GGFR Guidance at 14.

## BSEE Venting and Flaring Research

---

On March 11, 2016, the U.S. and Canada agreed to endorse the World Bank initiative to end routine gas flaring by 2030.<sup>81</sup> This commits the U.S. to providing a legal, regulatory, investment, and operating environment that is conducive to upstream investments, to the development of viable markets for the utilization of the gas, and to the infrastructure necessary to deliver gas to these markets. The goal is to provide companies with confidence and incentives as a basis for investing in flare-elimination solutions. As a result, the U.S. should require, and stipulate in their new prospect offers, that field development plans for new oil fields incorporate sustainable gas utilization or conservation without routine flaring. Furthermore, the governments will make every effort to ensure that routine flaring at existing oil fields ends as soon as possible and no later than 2030. This includes obligating the U.S. to publicly report its progress on an annual basis. Parties endorsing the initiative acknowledge that its success requires all involved – governments and oil companies, with the support of development institutions – to fully cooperate and take action to eliminate routine flaring no later than 2030.

### IV. Regulatory Development in the United States

Regulatory development in the United States is governed by several bodies. In May 2010, shortly after the Deepwater Horizon disaster, the United States Department of the Interior announced an internal reorganization in an effort to separate the major functions of offshore oil and gas management. This reorganization created the Bureau of Ocean Energy Management (BOEM) and the Bureau of Safety and Environmental Enforcement (BSEE) and reorganized the Minerals Management Service’s Minerals Revenue Management into the Office of Natural Resources Revenue (ONRR).<sup>82</sup>

BOEM is responsible for leasing federal waters in the Outer Continental Shelf, and BSEE is responsible for regulating federal waters through the Outer Continental Shelf Lands Act.<sup>83</sup> The Bureau of Land Management (BLM) is responsible for regulating and leasing federal lands, primarily through the Minerals Leasing Act.<sup>84</sup> Both BLM and BSEE establish the basis for policies on how companies should measure quantities of oil and gas and how BLM and BSEE are to conduct oil and gas production inspections and measurements. Additionally, companies are to report production volumes and sales values from leases to ONRR, which uses the information to verify that companies are accurately paying royalties.<sup>85</sup>

---

<sup>81</sup> World Bank Zero Routine Flaring by 2030, <http://www.worldbank.org/en/programs/zero-routine-flaring-by-2030>, accessed last April 10, 2016.

<sup>82</sup> GAO, *Oil and Gas Resources, Interior’s Production Verification Efforts and Royalty Data Have Improved but Further Actions Needed*, GAO-15-39, April 2015 at 5.

<sup>83</sup> *Id.*

<sup>84</sup> In addition to the MLA, the BLM also operates under the Mineral Leasing Act for Acquired Lands of 1947 (MLAAL), the Federal Oil and Gas Royalty Management Act (FOGRMA), the Federal Land Policy and Management Act of 1976 (FLPMA), the Indian Mineral Leasing Act of 1938 (IMLA), the Indian Mineral Development Act of 1982 (IMDA), and the Act of March 3, 1909.

<sup>85</sup> *Id.*

Federal air quality regulations are enforced through the United States Environmental Protection Agency (EPA), though many oil- and gas-producing states have their own sets of rules and standards, which can be more stringent than federal standards. For example, under the Clean Air Act (CAA), there are more stringent standard controls.

### *Regulatory Challenges*

The U.S. has recognized options for controlling venting and flaring using technologies that are feasible at particular production stages. These are summarized by the GAO in a report analyzing the potential for increased royalties and reduced emissions in each area of production:

- Drilling: One option is using “reduced emission” completion equipment when cleaning out a well before production. This separates mud and debris to capture gas or condensate that might otherwise be vented or flared.<sup>86</sup>
- Production: This option involves installing a plunger lift system to facilitate liquid unloading. This causes accompanying gas to go into the gas line rather than being vented.<sup>87</sup> Computerized timers can adjust when the plunger is dropped according to the rate at which liquid collects in the well, further decreasing venting.<sup>88</sup>
- Storage: This option involves installing vapor recovery units that capture gas vapor from oil or condensate storage tanks and send it into the pipeline.<sup>89</sup>
- Dehydration: One option is optimizing the circulation rate of glycol and adding a flash tank separator that reduces the amount of gas vented into the atmosphere.<sup>90</sup>
- Pneumatic devices: This option involves replacing pneumatic devices that release, or “bleed,” gas at a high rate (high-bleed pneumatics) with devices that bleed gas at a lower rate (low-bleed pneumatics).<sup>91</sup>

Furthermore, the EPA, after analyzing offshore drilling platforms, concluded that various production components, including valves and compressor seals, contribute significant volumes of fugitive emissions. These emissions could be mitigated through equipment repair or retrofiting.<sup>92</sup> However, the GAO recognized that many site operators were unaware of the economic advantages of investing in such technologies.<sup>93</sup> In part, this is because operators of smaller sites often do not have the resources to pursue these options.<sup>94</sup> EPA’s analysis warned

---

<sup>86</sup> GAO-11-34 at 7.

<sup>87</sup> GAO-11-34 at 8.

<sup>88</sup> *Id.*

<sup>89</sup> *Id.*

<sup>90</sup> *Id.*

<sup>91</sup> *Id.*

<sup>92</sup> GAO-11-34 at 26.

<sup>93</sup> GAO-11-34 at 24.

<sup>94</sup> *Id.*



## BSEE Venting and Flaring Research

---

that some mitigation strategies may be less cost-effective in the offshore environment because capital and installation costs tend to be higher.<sup>95</sup> In addition, smaller operations often do not have enough access to capital to purchase equipment, regardless of whether they can recover the costs. Many operators focus on efforts deemed by them to have a higher priority than incremental improvements in their operations.<sup>96</sup> While voluntary programs like the EPA Natural Gas STAR program can provide information and best practices, this may not be enough to spur industry to change. Overcoming “institutional inertia”—a company’s tendency to do business and carry out operations as it always has—would be key to their adopting these technologies.

Ultimately, the GAO has found U.S. regulatory oversight—whether onshore or offshore—to be limited.<sup>97</sup> Regulations limit venting and flaring of gas during routine procedures such as liquid unloading and well completions; however, oversight fails to address new capture technologies or all sources of lost gas.<sup>98</sup> The GAO also concluded that, except for the purpose of addressing air quality, agencies do not often assess options for reducing venting and flaring in advance of oil and gas production. According to the GAO, agencies have not developed, or have often failed to use adequately, information regarding available technologies that could reduce venting and flaring.<sup>99</sup> Agencies are thus limited in the following ways:

- ***Limits on Venting and Flaring from All Sources:*** For onshore operations, routine venting and flaring is limited based on volumetric totals, and permission is required to exceed these limits.<sup>100</sup> In evaluating requests, the BLM assesses the economic and technical feasibility of capturing gas. GAO noted, however, that this BLM guidance was over 30 years old, and as a result, did not address newer technologies or all sources of lost gas.<sup>101</sup> Offshore operations, then governed by the BSEE’s precursor organization, the Bureau of Ocean Energy Management, Regulation and Enforcement (BOEMRE), also had regulations. These regulations limited allowable volumes of gas but also enabled operators to request permission to exceed those limits.<sup>102</sup> Like BLM, BOEMRE evaluated the economic and technical feasibility of capturing gas.<sup>103</sup> The agency required operators to retain records on venting and flaring incidents and used these to identify economically feasible opportunities for installing control equipment.<sup>104</sup> Further, BOEMRE inspected offshore platform facilities each year and, as part of these

---

<sup>95</sup> GAO-11-34 at 26.

<sup>96</sup> *Id.*

<sup>97</sup> GAO-11-34 at 26.

<sup>98</sup> *Id.*

<sup>99</sup> GAO-11-34 at 26-27.

<sup>100</sup> GAO-11-34 at 27.

<sup>101</sup> *Id.*

<sup>102</sup> GAO-11-34 at 28.

<sup>103</sup> *Id.*

<sup>104</sup> *Id.* {Why not? – it is net profit, so it is worthwhile for the company, not including for society in the reduction in externalities }

inspections, reviewed onsite daily natural gas venting records.<sup>105</sup> Although regular inspections were conducted, the agency noted that daily venting records did not include all sources of vented gas. Thus, there was no opportunity for the agency to assess reduction potential comprehensively.<sup>106</sup>

- **Assessing Options Before Production:** The GAO noted that BLM did not explicitly assess options to minimize waste from vented and flared gas before production. Normally, this would happen during the environmental review phase and when operators apply to drill a new well.<sup>107</sup> BLM based this decision on state responsibility for the implementation and enforcement of air quality standards, which were typically assessed during this phase.<sup>108</sup> Reviews done by BOEMRE in advance of production focused on determining potential air quality impacts rather than waste<sup>109</sup> and required operators to submit a description of the technologies and recovery practices to be used during production. Venting and flaring reduction options were not included in this submission.<sup>110</sup>
- **Technology Information Sharing:** Since BLM did not maintain any database regarding the extent to which available reduction technologies were in use, it was difficult to identify opportunities for reducing venting and flaring or to estimate potential for increasing the capture of gas currently vented or flared.<sup>111</sup> BLM did not use infrared cameras to identify sources of lost gas, citing budgetary constraints and challenges in developing a policy and protocols. While BOEMRE did collect some information on the types of equipment used by operators, the agency did not analyze this information to identify emission-reduction opportunities.<sup>112</sup> However, unlike BLM, BOEMRE inspectors did use infrared cameras to look for obvious sources of vented and flared gas in a few sample locations close to shore. They noted that expanded use of the cameras could help identify and potentially reduce undetected gas emissions.<sup>113</sup>

The GAO concluded its report with several specific recommendations. First, it recommended that BLM revise its guidance to make clear that technologies should be used where they can economically capture vented and flared gas.<sup>114</sup> BLM and BOEMRE were directed to assess the potential use of venting and flaring reduction technologies to minimize waste in advance of production, not solely for purposes of air quality, and to consider expanded use of infrared

---

<sup>105</sup> *Id.*

<sup>106</sup> *Id.*

<sup>107</sup> GAO-11-34 at 29.

<sup>108</sup> *Id.*

<sup>109</sup> GAO-11-34 at 29-30. While

<sup>110</sup> GAO-11-34 at 29-30.

<sup>111</sup> GAO-11-34 at 30.

<sup>112</sup> GAO-11-34 at 31.

<sup>113</sup> *Id.*

<sup>114</sup> GAO-11-34 at 34.



## BSEE Venting and Flaring Research

---

cameras.<sup>115</sup> Finally, the GAO recommended that BLM and BOEMRE collect information on the extent to which larger operators use reduction technology and periodically review this information to identify potential opportunities for emission reductions.<sup>116</sup>

### *Current Offshore Regulations and Guidance*<sup>117</sup>

According to current regulations and guidance governing venting and flaring on the US Continental Shelf, an operator must request and receive approval from the BSEE Regional Supervisor to flare or vent natural gas except in specific situations, which are outlined in the Code of Federal Regulations (CFR) and in BSEE directives. These situations include operational testing, emergencies, and equipment failures, as well as allowing venting and flaring where the gas is lease-use gas or is necessary to burn additional waste products.<sup>118</sup> In these situations, duration and volumes are managed and limited by regulation and by the filing of operations plans. Even with these allowances, however, shorter time limits or additional volume restrictions may be imposed to prevent air quality degradation or the loss of reserves.<sup>119</sup>

Facilities processing more than an average of 2,000 barrels of oil per day (bopd) must install flare/vent meters, which must measure within 5% accuracy and be used and maintained for the life of the facility.<sup>120</sup> Operators are required to report on amounts of gas vented or flared and maintain records onsite detailing incidents of flaring and venting, including their amounts, and durations.<sup>121</sup> If meters are not required at a facility, operators may report gas flared or vented on a lease or unit basis.<sup>122</sup> As of now, requests to flare or vent gas are denied unless absolutely necessary. Reasons qualifying as absolutely necessary include national interest, safety, and maximizing oil recovery. Violations could result in civil and/or criminal penalties.<sup>123</sup>

BSEE has stated its regulatory approach rests on balancing the need to reduce emissions with the need to allow venting and flaring when required by safety issues and in order to prevent danger to life and property. In 2012, BSEE issued additional guidance on flaring and venting metering and the processing of requests for approval to flare or vent. Notice to Lessees (NTL) No. 2012 N-03 addressed meter installations and accuracy, and NTL 2012-N04 provided guidance for requesting approval to flare or vent natural gas and provided guidance for the discretionary authority of BSEE to approve such requests. In particular, NTL 2012-N04 represented a more

---

<sup>115</sup> *Id.*

<sup>116</sup> *Id.*

<sup>117</sup> The complete text of the regulations and expanded summaries of BSEE guidance is included as a separate appendix.

<sup>118</sup> 30 CFR §250.1160. Lease-use gas is produced national gas which is used on or for the benefit of lease operations such as gas used to operate production facilities.

<sup>119</sup> 30 CFR §250.1160, 1161.

<sup>120</sup> 30 CFR §250.1163.

<sup>121</sup> *Id.*

<sup>122</sup> *Id.*

<sup>123</sup> 30 CFR §250.1160.

strict policy and improved BSEE’s conservation enforcement. No flaring or venting without permission would be allowed except in limited circumstances permitted on a case-by-case basis at BSEE’s discretion. These limited circumstances include:

- When the BSEE Director determines flaring or venting is in the national interest, such as when a major hurricane causes widespread and catastrophic gas infrastructure damage, leading to significant declines in national oil production and rapidly escalating oil prices;
- When the operator demonstrates to the Regional Supervisor’s satisfaction that production from the well completion would likely be permanently lost if the well is shut in; or
- When the operator demonstrates to the Regional Supervisor’s satisfaction that short-term flaring or venting would likely yield a smaller volume of lost natural gas than if the facility were shut in and restarted later (with flaring and venting necessary to restart the facility).

When considering requests to approve flaring or venting, BSEE does not consider the avoidance of lost revenue to be a justifiable reason. Any requests for venting and flaring based on the need to avoid the installation of gas transportation or conditioning equipment will not be approved unless the cost of installing the equipment makes the entire project, including oil produced from the facility, uneconomic.<sup>124</sup>

In 2015, BSEE issued further guidance to govern procedures for use by Resource Conservation Section (RCS) personnel in processing flaring and venting requests; namely, the Bureau Interim Directive (BID)-2015-G070, *Standard Operating Procedures for Processing and Issuing Decisions Regarding Flaring, Venting, and Burning Requests; Requests to Produce Within 500-ft of Lease/Unit Boundary; Gas Cap Production Requests; and Downhole Commingling Requests*. The BID notes that requests to flare or vent beyond allowed thresholds should be denied unless an exception outlined in NTL No. 2012-N04 applies. The BID also clarified the situations in which those NTL exceptions would be granted. For exception #1 to apply—national interest—direction must be given from top BSEE management. For exception #2 to apply—permanent loss of production—RCS personnel will 1) examine the well-completion history to determine if there is “solid evidence” of increased problems bringing the completion back online after a shut in; 2) evaluate the most recent well test data if the operator is claiming flow assurance concerns; 3) discuss historical flow assurance strategies (in particular looking at the last three times the well(s) were shut in); and 4) determine if a minimum flowrate exists at which the well completion can be produced. For exception #3 to apply—less lost natural gas—RCS personnel will evaluate the historical data (again focusing on the last three instances) and the well-test data to confirm that the operator’s requested rates are reasonable and to confirm that high-gas/oil-ratio (GOR) wells (wells with a GOR of greater than 1500 SCF/STB) are not being produced. The guidance notes that initial flaring/venting approvals should not exceed the time estimated to reach the first milestone. Before an extension to the flaring/venting approval can be granted, a recapitulation report listing progress since the last flaring/venting approval or extension should be supplied by the operator. If significant progress has not been made,

<sup>124</sup> BSEE, Conservation Enforcement of Oil and Gas Resources on the Outer Continental Shelf, Bureau of Safety and Environmental Enforcement, Sept. 28, 2012 (“BSEE Conservation Enforcement”).

## BSEE Venting and Flaring Research

---

additional flaring/venting usually will not be approved, and extensions should not be made if volumes or conditions change such that the total cumulative volume flared/vented would exceed the restart flare/vent volume.

BSEE notes that approval of requests has become more challenging in recent years due in part, to the deepwater facilities and the sizeable flaring and venting volumes that can occur when pieces of equipment on these facilities break down.

BSEE also conducted an internal review of regulations following the Deepwater Horizon catastrophe in April 2010, *An Internal Review of BSEE Regulations Thirty Months After Macondo, Oct. 2012* (“BSEE Internal Review”), which noted significant areas for improvement in regulatory oversight with regard to flaring and venting.

In 2015, BSEE also issued additional guidance on inspection procedures and guidance pertaining to the flaring or venting of low-volume flash gas from storage or other low-pressure production vessels. This guidance also provides associated inspection procedures.<sup>125</sup> Inspection procedures were detailed to verify compliance with CFR Part 250, Sections 1160 and 1163, and directed inspectors to verify operator calculations of flared and vented gas volumes, proper recording of volumes, and maintenance of records. If inspectors observed that gas volumes exceeded 50 MCF/D without verified approval, or if there appeared to be “suspect” operator records, inspectors were required to issue a report.<sup>126</sup> ONRR was then notified if operators flared or vented “avoidably lost” gas.<sup>127</sup> BSEE required Office of Production and Development (OPD) personnel to witness 10% of all oil sales meter provings<sup>128</sup> and 5% of gas meter provings and to conduct site security inspections for regulatory compliance and protection of federal production.<sup>129</sup> BSEE also noted that gas flaring inspections would be conducted by inspection personnel to ensure operator adherence to gas flaring regulations and any conditions of flaring approval.<sup>130</sup> Finally, BSEE provided standard operating procedures for measurement inspections.<sup>131</sup>

---

<sup>125</sup> BID-2015-G069, *Guidance and Inspection Procedures RE Documentation Requirements for Flaring or Venting of Low-Volume Flash Gas*, Sept. 1, 2015.

<sup>126</sup> *Id.*

<sup>127</sup> *Id.*

<sup>128</sup> Meter “provings” test meters for accuracy.

<sup>129</sup> BID-2015-P015, *Procedures Regarding Production Management, Site Security, and Gas Flaring Inspections*, Sept. 8, 2015.

<sup>130</sup> *Id.*

<sup>131</sup> BID2015-G096, *Standard Operating Procedures for Performing Measurement Inspections, MIU, MAES*, Sept. 15, 2015.

## *Comparison of BLM and BSEE Regulations as of 2015*

In 2015, the GAO undertook another review, which summarized the progress made by BLM and BSEE in improving production verification and royalty data and which also included a comparison of the two regulatory regimes.<sup>132</sup> Summaries of the major GAO findings are reported below with regard to offshore operations

The GAO noted its prior findings in 2010 and expressed ongoing concerns with Interior’s management of federal oil and gas resources, including concern about the lack of ability to provide reasonable assurance that royalty data were complete and accurate.<sup>133</sup> In particular, the report discussed BLM challenges with updating its regulations and guidance for onshore oil and gas measurement and site security.<sup>134</sup> While the GAO found that BLM and BSEE have both failed to meet self-imposed Production Accountability Inspection Program goals, the report noted that BSEE was coming closer to meeting its goals.<sup>135</sup>

### *Existing BLM Requirements*

Venting, flaring, and royalty-free uses of oil and natural gas on BLM-administered leases are currently governed by NTL–4A, which was issued by the U.S. Geological Survey on December 27, 1979. This was before the BLM assumed oversight responsibility for onshore oil and gas development and production. NTL–4A prohibits venting or flaring of gas well gas, and it prohibits venting or flaring of oil well gas unless approved in writing by the “Supervisor.” Both prohibitions are subject to specified exemptions for emergencies, certain equipment malfunctions, certain well tests, and vapors from storage vessels.

With respect to venting or flaring, NTL–4A IV.B allows approval of an application for the venting or flaring of oil well gas if justified by the submittal of two documents:

1. An evaluation report supported by engineering, geologic, and economic data demonstrating that the expenditures necessary to market or beneficially use such gas are not economically justified. This report must also show that conservation of the gas, if required, would lead to the premature abandonment of recoverable oil reserves and ultimately to a greater loss of equivalent energy than would be recovered if the venting or flaring were permitted to continue; or
2. An action plan that will eliminate venting or flaring of the gas within one year from the date of application. “When evaluating the feasibility of requiring conservation of the gas, the total leasehold production, including both oil and gas, as well as the economics of a field wide plan shall be considered.

---

<sup>132</sup> GAO, *Oil and Gas Resources, Interior’s Production Verification Efforts and Royalty Data Have Improved but Further Actions Needed*, GAO-15-39, April 2015.

<sup>133</sup> GAO-15-39 at 14; 15.

<sup>134</sup> GAO-15-39 at 16-17.

<sup>135</sup> GAO-15-39 at 23 (expressing concern on requirements for in-person verification of oil meter provings and gas meter calibrations).

## BSEE Venting and Flaring Research

---

BLM does authorize royalty-free venting or flaring of gas “on a short-term basis” without the need for approval under specified circumstances, including:

- Emergency situations, such as equipment failures, for up to 24 hours per incident and up to 144 cumulative hours per lease per month;
- The unloading or cleaning up of a well during drillstem, producing, routine purging, or evaluation tests, not exceeding a period of 24 hours; or
- Initial well evaluation tests, for up to 30 days or up to 50 million cubic feet (MMcf) of gas, whichever occurs first.<sup>136</sup>

### *Pending BLM Regulations*

New rules have been proposed by BLM to limit venting and flaring of produced natural gas. These rules would place new limits on gas flaring during normal production operations from development oil wells.<sup>137</sup> In considering how to reduce flaring, BLM states that it is important to recognize that gas is flared under a variety of circumstances, some of which are unplanned or unavoidable in the course of normal oil and gas production.<sup>138</sup> Emergencies can occur through an unforeseen event, such as a weather-related incident or an accident that damages equipment, or because operators do not yet know whether there will be a sufficient quantity of gas available to capture.<sup>139</sup> In addition, BLM noted inadequate maintenance or oversight can result in avoidable waste of gas.<sup>140</sup> As a result, the agency concluded that the development of new alternative capture technologies calls into question whether there are no alternatives to flaring when a field produces only a small quantity of natural gas.<sup>141</sup>

In many instances, however, BLM found the decision to flare large quantities of gas to be driven by an operator’s economic calculation that the value of immediately producing the oil outweighed the value of the natural gas that could be captured.<sup>142</sup> Two circumstances that resulted in substantial ongoing or intermittent flaring of gas were: (1) flaring in areas with existing capture infrastructure, but where the rate of new-well construction was outpacing the infrastructure capacity; and (2) flaring in areas where capture and processing infrastructure had not yet been built out. The first situation occurs in areas that have extensive natural-gas gathering lines, which are connected to pipelines leading to processing plants. However, in many areas in recent years, the rate of oil development and the rapid rise in quantities of associated gas have overwhelmed the capacity of the gathering lines and/or processing plants. New wells (especially in shale formations) often

---

<sup>136</sup> 81 F.R. 6628.

<sup>137</sup> BLM, *Regulatory Impact Analysis for Revisions to 43 CFR § 3100, 3600 and Addition of § 3178 and 3179*, Jan. 2016 (“Reg. Impact Analysis”) at 1.

<sup>138</sup> 81 F.R. 6637.

<sup>139</sup> *Id.*

<sup>140</sup> 81 F.R. 6638.

<sup>141</sup> 81 F.R. 6637 (requesting further comment).

<sup>142</sup> *Id.*

start out producing a relatively large amount of oil and/or gas at relatively high pressures, which then declines rapidly over time. Thus, each time a new oil well with associated gas connected to the gathering system starts production, it may increase the pressures on the system above the pressures generated by existing producing wells, pushing those wells off the gathering system. Operators of these existing wells then must choose between shutting in or throttling the well, employing other technologies to use the gas, reinjecting the gas, or flaring. 81 F.R. 6638. The second situation occurs when gas capture infrastructure has not yet been built out to a particular field or well, even though the well is expected to produce substantial quantities of gas. In many instances, operators or midstream processing companies plan to construct gathering lines, but the rate of oil-well development outpaces the rate of development of capture infrastructure. 81 F.R. 6638. BLM proposes to address both circumstances.

In both situations, lack of adequate planning and communication could result in flaring.<sup>143</sup> North Dakota’s recognition of this cause of flaring led the state to require that an operator provide an affidavit at the well-permitting stage stating that the operator met with gathering companies and informed them of the operator’s expected well-development timing and production levels.<sup>144</sup>

The proposed rule would update the BLM’s existing NTL–4A requirements related to venting, flaring, and royalty-free use of natural gas from onshore federal and Indian leases.<sup>145</sup> To reduce the need for case-by-case determinations of exemptions, BLM proposes to clarify when flared or vented natural gas is subject to royalties.<sup>146</sup> Gas flared from a well connected to infrastructure would be royalty-bearing except in certain narrow circumstances, such as emergencies. With respect to venting and flaring of natural gas, BLM proposes to prohibit venting except in certain limited circumstances; limit the rate of routine flaring at development oil wells; and require operators to detect and repair leaks. The rules would also mandate reductions in venting from pneumatic controllers and pumps that operate by releasing natural gas; storage vessels; activities to unload liquids from a well; and well-drilling, completion, and testing activities.<sup>147</sup> The rule would require operators to submit information about anticipated gas production and planned gas disposition in conjunction with the Application for Permit to Drill.<sup>148</sup> To reduce the amount of gas lost during well drilling, BLM is proposing that the gas from drilling operations be either captured and routed to a sales line, combusted, re-injected, or used for production purposes onsite.<sup>149</sup>

Finally, as a practical matter, BLM noted many of the proposed requirements would impact only existing equipment or facilities that are not regulated by EPA New Source Performance Standards, Subpart OOOO, nor by the EPA’s recently proposed Subpart OOOOa, if that rule is finalized.<sup>150</sup>

---

<sup>143</sup> 81 F.R. 6638.

<sup>144</sup> *Id.*

<sup>145</sup> 81 F.R. 6617.

<sup>146</sup> *Id.*

<sup>147</sup> *Id.*

<sup>148</sup> Reg. Impact Analysis at 25.

<sup>149</sup> *Id.*

<sup>150</sup> *Id.*



## BSEE Venting and Flaring Research

---

### *Venting and Flaring*

The BLM is proposing to prohibit venting of natural gas, except under certain conditions which would be addressed in the regulations, (for example, emergencies).<sup>151</sup> The BLM proposes to simplify, clarify, and strengthen its approach to reducing flaring by establishing clear parameters for when routine flaring from development wells is allowed and by setting a limit on the rate of flaring from individual wells.<sup>152</sup> Flaring from development oil wells would be limited to the following amounts:

- 7,200 Mcf/well/month on average across the lease for the first year of the rule’s implementation;
- 3,600 Mcf/well/month on average across the lease for the second year of the rule’s implementation; and
- 1,800 Mcf/well/month on average across the lease thereafter.<sup>153</sup>

The BLM estimates that this limit would reduce flaring by up to 74%, although there is substantial uncertainty regarding this estimate.<sup>154</sup> As a general matter, operators would no longer have to obtain permission for flaring on a case-by-case basis, provided they stay within the proposed prescribed limit. However, BLM would retain the authority to allow higher rates of flaring in specific circumstances, where adhering to the proposed flaring limit would impose such costs as to cause the operator to cease production and abandon significant recoverable oil reserves under the lease.<sup>155</sup> Exemptions to these limits would include

1. The current exemptions from gas capture requirements and royalties for gas flared in other situations, as long as the operator has complied with the proposed requirements to minimize such losses;
2. Gas lost in the normal course of well drilling and well completion;
3. Well tests;
4. Emergencies, as would be defined in the regulations; and
5. Gas flared from exploration, wildcat wells (wells drilled in an unproven area, that has no historic production records), or delineation wells (wells drilled to define the boundaries of a mineral deposit).<sup>156</sup>

---

<sup>151</sup> 81 F.R. 6619.

<sup>152</sup> *Id.*

<sup>153</sup> The respective flaring limits of 7,200 Mcf/month, 3,600 Mcf/month, and 1,800 Mcf/month equate to roughly 240 Mcf/day, 120 Mcf/day, and 60 Mcf/day, respectively. Re. Impact Analysis at 25. This limit is similar to requirements in Wyoming and Utah, which limit flaring to 60 Mcf/day and 1,800 Mcf/month, respectively, unless the operator obtains state approval of a higher limit. *Id.*

<sup>154</sup> *Id.*

<sup>155</sup> *Id.*

<sup>156</sup> *Id.*

In making its determination, the BLM would consider the costs of capture and the costs and revenues of all oil and gas production on the lease.<sup>157</sup> Finally, gas must be metered if flaring exceeds 50 Mcf/day,<sup>158</sup> and estimations would be allowed (as opposed to the measurement of small volumes of lost gas) since the agency concluded that any additional accuracy provided by meters may not be justified by the cost.<sup>159</sup>

The BLM also proposes to create a two-year renewable exemption from the flaring limit, available only for certain existing leases that are located a significant distance from gas processing facilities and that are flaring at a rate well above the proposed flaring limit.<sup>160</sup> Holders of these leases have, until now, had no prior notice of the proposed flaring limit. Given the significant distance of these leases to the nearest gas capture facilities and given the leases' high rates of gas flaring, operators at these sites might have few options to meet the proposed flaring limit other than shutting in the wells.<sup>161</sup> The BLM anticipates the number of leases eligible for this exemption would decline over time, as production of oil and gas from existing leases naturally declines.<sup>162</sup>

The agency believes that these regulations will not only establish a standard applicable to the largest gas-flaring operations, but will afford operator flexibility to choose how to meet limits. The operator could install capture infrastructure, use onsite capture and transportation technologies, use the gas for other production purposes, reinject the gas, or curtail production sufficiently to meet the limits.<sup>163</sup> The limit would reduce gas flaring and conserve a portion of the gas until the operator could make arrangements to capture the gas and bring it to market.<sup>164</sup>

Finally, BLM addressed the need for action by BLM even as EPA proposes additional standards. BLM stated that while the proposed EPA standards are expected to reduce methane emissions from certain new and modified oil and gas production facilities, they would not be sufficient to meet the goals of BLM's proposed rule for several reasons.<sup>165</sup> First, the proposed EPA regulations do not include any provisions to reduce flaring of gas during normal production operations. Second, even with respect to venting, the EPA regulations would apply only to new and modified sources. On the other hand, this proposal would reach existing sources as well. Finally, because the EPA's legal authorities differ from those of the BLM, the proposed EPA

---

<sup>157</sup> 81 F.R. 6620.

<sup>158</sup> Reg. Impact Analysis at 25.

<sup>159</sup> 81 F.R. 6642.

<sup>160</sup> *Id.*

<sup>161</sup> *Id.*

<sup>162</sup> *Id.*

<sup>163</sup> Reg. Impact Analysis at 26.

<sup>164</sup> *Id.*

<sup>165</sup> 81 F.R. 6636.



## BSEE Venting and Flaring Research

---

regulations do not cover all BLM-regulated activities, such as well maintenance and liquids unloading.<sup>166</sup>

Similarly, of the states with extensive oil and gas operations on BLM-administered leases, only one has comprehensive requirements to reduce flaring, and only one has comprehensive statewide requirements to control losses from venting and leaks.<sup>167</sup> Moreover, state regulations do not apply to BLM-administered oil and gas leases on Indian lands, and states do not have a statutory mandate to reduce waste of federal oil and gas.

### *Clean Air Act Regulations*

The EPA regulates releases of HAPs and nonmethane volatile organic compounds (VOCs) from oil and gas production operations through National Emission Standards for Hazardous Air Pollutants (NESHAPs) and New Source Performance Standards (NSPS) provision of the Clean Air Act (CAA). With regard to NSPS regulations, Section 111 of the Clean Air Act, “Standards of Performance of New Stationary Sources,” requires the EPA to establish federal emission standards for source categories that cause or contribute significantly to air pollution. These standards are intended to promote use of the best air pollution control technologies, taking into account the cost of such technology; energy requirements; and any nonair quality, health, and environmental impact. For oil and gas operations, this often means controlling vented releases from storage tanks.

The EPA Outer Continental Shelf (OCS) Air Program, authorized by §328 of the Clean Air Act, created separate regimes for OCS located within 25 miles of a state’s seaward boundary (“inner OCS sources”) and another for OCS sources located beyond 25 miles extending to the boundary of the Exclusive Economic Zone (EEZ) (“outer OCS sources”).<sup>168</sup>

Outer OCS requirements are fewer and relatively less complex because these sources need only comply with federal regulations.<sup>169</sup> These sources are potentially subject to the CAA’s Prevention of Significant Deterioration (PSD) program.<sup>170</sup> Additionally, an OCS source must

---

<sup>166</sup> *Id.*

<sup>167</sup> *Id.* The regulatory impact analysis makes reference to both North Dakota and Wyoming as having comprehensive regulatory regimes but it’s not clear which state is specifically referenced here and characterized this way in the CFR.

<sup>168</sup> Congressional Research Service, *Controlling Air Emissions from Outer Continental Shelf Sources: A Comparison of Two Programs – EPA and DOI*; CRS 7-5700 R42123, Nov. 26, 2012 (“CRS Report”).

<sup>169</sup> CRS Report at 9; 40 CFR Part 55

<sup>170</sup> CRS Report at 9-10. Congress added the PSD program to the CAA in 197739 to address new or modified emission sources that would affect areas meeting National Ambient Air Quality Standards (NAAQS). The primary objective of the program is to ensure that the air quality does not degrade in these areas with the addition of a new (or modified) source. An OCS source that qualifies as a “major stationary source” must comply with PSD provisions. The primary determinant is an annual emissions threshold. For any stationary source, the threshold is 250 tons per year (tpy) of a regulated pollutant. Some specific emission sources have a lower threshold of 100 tpy. Oil and gas exploration, development, and

consider its greenhouse gas (GHG) emissions, which are subject to different thresholds. As a result, the EPA may also require a source to continue to monitor ambient air emissions during its operation to determine the effect of the emissions, though a source may be exempted if its emission levels are below pollutant-specific thresholds.<sup>171</sup> EPA does provide some exemptions for temporary sources such as exploratory drilling operations from certain PSD program requirements.<sup>172</sup>

Inner OCS sources are subject to all of the requirements as outer sources as well as any applicable state and/or local air emission requirements.<sup>173</sup> In a nonattainment area (that is, an area which has not achieved its air quality standard as set by the Clean Air Act), an inner OCS source may be subject to the lowest achievable emission rate (LAER), which is by definition more stringent than best available control technology (BACT). In addition, emissions from new or modified sources must also be offset by reductions in emissions from existing sources.<sup>174</sup>

As mentioned on page \_\_, in 2012 the EPA finalized its Oil and Natural Gas Sector: New Source Performance Standards (NSPS) Subpart OOOO, which established standards for EPA’s regulation of volatile organic compound (VOC) emissions from “new” and “modified” sources in the oil and natural gas sectors. It does not address sources in existence prior to the date the NSPS was proposed, unless those sources are modified or replaced at some future time. NSPS Subpart OOOO addresses emissions from hydraulically fractured gas-well completion operations, storage vessels emitting more than 6 tons per year of uncontrolled VOC, continuous bleed pneumatic controllers, and other sources. It applies to operations nationwide, including those on federal and Indian lands, and it has a co-benefit of reducing the loss of gas from certain sources.

The EPA is currently reviewing responses to a request for additional data and information on emissions of hazardous air pollutants (air toxics) that were not available in 2012 when EPA updated its major air standards for oil and natural gas production facilities and natural gas transmission and storage facilities.<sup>175</sup> On November 27, 2015, the EPA requested information related to hazardous air pollutant emissions from sources in the oil and natural gas production and natural gas transmission and storage segments of the oil and natural gas sector.

---

production activities are not among these specific sources. 43 Regardless, many OCS sources from the oil/gas industry are likely to approach or breach the 250 tpy threshold (Table 2). CRS Report at 9.

<sup>171</sup> CRS Report at 11.

<sup>172</sup> *Id.* The exemption has two conditions. First, regulated emissions from the major stationary source must not impact a Class I area (discussed above). Second, the source’s emissions must be “temporary.” EPA has not defined “temporary” in the PSD regulations, but in a 1980 Federal Register preamble, EPA stated that it considered sources operating for less than two years in a given location to be temporary sources. Sources meeting the conditions of the exemption are not subject to the air quality demonstration and analyses discussed above. Several OCS exploratory drilling operations that received EPA air permits qualified as temporary sources.

<sup>173</sup> CRS Report at 13 (noting that in case of conflicts, the more stringent provisions control).

<sup>174</sup> *Id.*

<sup>175</sup> EPA Request for Comments on 40 CFR Part 63

## **APPENDIX I**

### **Current Offshore Regulations Regarding the Venting and Flaring of Natural Gas**

**Current Offshore Regulations Regarding the Venting and Flaring of Natural Gas**  
 30 CFR Part 250

***§250.1160 When may I flare or vent gas?***

(a) You must request and receive approval from the Regional Supervisor to flare or vent natural gas at your facility, except in the following situations:

(1) When the gas is lease use gas (produced natural gas which is used on or for the benefit of lease operations such as gas used to operate production facilities) or is used as an additive necessary to burn waste products, such as H <sub>2</sub> S	The volume of gas flared or vented may not exceed the amount necessary for its intended purpose. Burning waste products may require approval under other regulations.
(2) During the restart of a facility that was shut in because of weather conditions, such as a hurricane	Flaring or venting may not exceed 48 cumulative hours without Regional Supervisor approval.
(3) During the blow down of transportation pipelines downstream of the royalty meter	(i) You must report the location, time, flare/vent volume, and reason for flaring/venting to the Regional Supervisor in writing within 72 hours after the incident is over. (ii) Additional approval may be required under subparts H and J of this part.
(4) During the unloading or cleaning of a well, drill-stem testing, production testing, other well-evaluation testing, or the necessary blow down to perform these procedures	You may not exceed 48 cumulative hours of flaring or venting per unloading or cleaning or testing operation on a single completion without Regional Supervisor approval.
(5) When properly working equipment yields flash gas (natural gas released from liquid hydrocarbons as a result of a decrease in pressure, an increase in temperature, or both) from storage vessels or other low-pressure production vessels, and you cannot economically recover this flash gas	You may not flare or vent more than an average of 50 MCF per day during any calendar month without Regional Supervisor approval.
(6) When the equipment works properly but there is a temporary upset condition, such as a hydrate or paraffin plug	(i) For oil-well gas and gas-well flash gas (natural gas released from condensate as a result of a decrease in pressure, an increase in temperature, or both), you may not exceed 48 continuous hours of flaring or venting without Regional Supervisor approval.(ii) For primary gas-well gas (natural gas from a gas well completion that is at or near its

	<p>wellhead pressure; this does not include flash gas), you may not exceed 2 continuous hours of flaring or venting without Regional Supervisor approval. (iii) You may not exceed 144 cumulative hours of flaring or venting during a calendar month without Regional Supervisor approval.</p>
<p>(7) When equipment fails to work properly, during equipment maintenance and repair, or when you must relieve system pressures</p>	<p>(i) For oil-well gas and gas-well flash gas, you may not exceed 48 continuous hours of flaring or venting without Regional Supervisor approval. (ii) For primary gas-well gas, you may not exceed 2 continuous hours of flaring or venting without Regional Supervisor approval. (iii) You may not exceed 144 cumulative hours of flaring or venting during a calendar month without Regional Supervisor approval. (iv) The continuous and cumulative hours allowed under this paragraph may be counted separately from the hours under paragraph (a)(6) of this section.</p>

(b) Regardless of the requirements in paragraph (a) of this section, you must not flare or vent gas over the volume approved in your Development Operations Coordination Document (DOCD) or your Development and Production Plan (DPP) submitted to BOEM.

(c) The Regional Supervisor may establish alternative approval procedures to cover situations when you cannot contact the BSEE office, such as during non-office hours.

(d) The Regional Supervisor may specify a volume limit, or a shorter time limit than specified elsewhere in this part, in order to prevent air quality degradation or loss of reserves.

(e) If you flare or vent gas without the required approval, or if the Regional Supervisor determines that you were negligent or could have avoided flaring or venting the gas, the hydrocarbons will be considered avoidably lost or wasted.

You must pay royalties on the loss or waste, according to 30 CFR part 1202. You must value any gas or liquid hydrocarbons avoidably lost or wasted under the provisions of 30 CFR part 1206.

(f) Fugitive emissions from valves, fittings, flanges, pressure relief valves or similar components do not require approval under this subpart unless specifically required by the Regional Supervisor.

***§250.1161 When may I flare or vent gas for extended periods of time?***

You must request and receive approval from the Regional Supervisor to flare or vent gas for an extended period of time. The Regional Supervisor will specify the approved period of time, which will not exceed 1 year. The Regional Supervisor may deny your request if it does not ensure the conservation of natural resources or is not consistent with National interests relating to development and production of minerals of the OCS. The Regional Supervisor may approve your request for one of the following reasons:

- (a) You initiated an action which, when completed, will eliminate flaring and venting; or
- (b) You submit to the Regional Supervisor an evaluation supported by engineering, geologic, and economic data indicating that the oil and gas produced from the well(s) will not economically support the facilities necessary to sell the gas or to use the gas on or for the benefit of the lease.

***§250.1163 How must I measure gas flaring or venting volumes and liquid hydrocarbon burning volumes, and what records must I maintain?***

(a) If your facility processes more than an average of 2,000 bopd during May 2010, you must install flare/vent meters within 180 days after May 2010. If your facility processes more than an average of 2,000 bopd during a calendar month after May 2010, you must install flare/vent meters within 120 days after the end of the month in which the average amount of oil processed exceeds 2,000 bopd.

- (1) You must notify the Regional Supervisor when your facility begins to process more than an average of 2,000 bopd in a calendar month;
- (2) The flare/vent meters must measure all flared and vented gas within 5 percent accuracy;
- (3) You must calibrate the meters regularly, in accordance with the manufacturer's recommendation, or at least once every year, whichever is shorter; and
- (4) You must use and maintain the flare/vent meters for the life of the facility.

(b) You must report all hydrocarbons produced from a well completion, including all gas flared, gas vented, and liquid hydrocarbons burned, to Office of Natural Resources Revenue on Form ONRR-4054 (Oil and Gas Operations Report), in accordance with 30 CFR 1210.102.

- (1) You must report the amount of gas flared and the amount of gas vented separately.
- (2) You may classify and report gas used to operate equipment on the lease, such as gas used to power engines, instrument gas, and gas used to maintain pilot lights, as lease use gas.
- (3) If flare/vent meters are required at one or more of your facilities, you must report the amount of gas flared and vented at each of those facilities separately from those facilities that do not require meters and separately from other facilities with meters.
- (4) If flare/vent meters are not required at your facility:
  - (i) You may report the gas flared and vented on a lease or unit basis. Gas flared and vented from multiple facilities on a single lease or unit may be reported together.
  - (ii) If you choose to install meters, you may report the gas volume flared and vented according to the method specified in paragraph (b)(3) of this section.

(c) You must prepare and maintain records detailing gas flaring, gas venting, and liquid hydrocarbon burning for each facility for 6 years.

- (1) You must maintain these records on the facility for at least the first 2 years and have them available for inspection by BSEE representatives.

- (2) After 2 years, you must maintain the records, allow BSEE representatives to inspect the records upon request and provide copies to the Regional Supervisor upon request, but are not required to keep them on the facility.
- (3) The records must include, at a minimum:
  - (i) Daily volumes of gas flared, gas vented, and liquid hydrocarbons burned;
  - (ii) Number of hours of gas flaring, gas venting, and liquid hydrocarbon burning, on a daily and monthly cumulative basis;
  - (iii) A list of the wells contributing to gas flaring, gas venting, and liquid hydrocarbon burning, along with gas-oil ratio data;
  - (iv) Reasons for gas flaring, gas venting, and liquid hydrocarbon burning; and
  - (v) Documentation of all required approvals.
- (d) If your facility is required to have flare/vent meters:
  - (1) You must maintain the meter recordings for 6 years.
    - (i) You must keep these recordings on the facility for 2 years and have them available for inspection by BSEE representatives.
    - (ii) After 2 years, you must maintain the recordings, allow BSEE representatives to inspect the recordings upon request and provide copies to the Regional Supervisor upon request, but are not required to keep them on the facility.
    - (iii) These recordings must include the begin times, end times, and volumes for all flaring and venting incidents.
  - (2) You must maintain flare/vent meter calibration and maintenance records on the facility for 2 years.
- (e) If your flaring or venting of gas, or burning of liquid hydrocarbons, required written or oral approval, you must submit documentation to the Regional Supervisor summarizing the location, dates, number of hours, and volumes of gas flared, gas vented, and liquid hydrocarbons burned under the approval.

***§250.1164 What are the requirements for flaring or venting gas containing H2S?***

- (a) You may not vent gas containing H2S, except for minor releases during maintenance and repair activities that do not result in a 15-minute time-weighted average atmosphere concentration of H2S of 20 ppm or higher anywhere on the platform.
- (b) You may flare gas containing H2S only if you meet the requirements of §§250.1160, 250.1161, 250.1163, and the following additional requirements:
  - (1) For safety or air pollution prevention purposes, the Regional Supervisor may further restrict the flaring of gas containing H2S. The Regional Supervisor will use information provided in the lessee's H2S Contingency Plan (§250.490(f)), Exploration Plan, DPP, DOCD submitted to BOEM, and associated documents to determine the need for restrictions; and



(2) If the Regional Supervisor determines that flaring at a facility or group of facilities may significantly affect the air quality of an onshore area, the Regional Supervisor may require you to conduct an air quality modeling analysis, under 30 CFR 550.303, to determine the potential effect of facility emissions. The Regional Supervisor may require monitoring and reporting, or may restrict or prohibit flaring, under 30 CFR 550.303 and 30 CFR 550.304.

(c) The Regional Supervisor may require you to submit monthly reports of flared and vented gas containing H<sub>2</sub>S. Each report must contain, on a daily basis:

- (1) The volume and duration of each flaring and venting occurrence;
- (2) H<sub>2</sub>S concentration in the flared or vented gas; and
- (3) The calculated amount of SO<sub>2</sub> emitted.

BSEE’s regulatory approach rests on balancing the need to reduce emissions with the need to allow venting and flaring when required by safety issues and in order to prevent danger to life and property. In 2012, BSEE issued additional guidance on flaring and venting metering and the processing of requests for approval to flare or vent:

- ***NTL No. 2012 N-03***, Flare/Vent Meter Installations, which clarified meter accuracy standards since the currently available technologies may not achieve the high accuracy standard required over the full range of possible flow rates. BSEE concluded that meters installed should be capable of measurement within 5 percent accuracy over the range from 50 MCF per day to a maximum flow rate expected in the most probable high rate emergency flaring scenarios, if achievable using standard applications of currently available metering technologies. If nothing can meet these requirements under a site’s particular flow conditions, operators must install the best meter technology available and may satisfy the requirement by meeting the uncertainty standard given in the API MPMS Chapter 14, Section 10.5.1.<sup>176</sup> Some limited exceptions would apply:
  - Venting systems associated with vessels that operate in atmospheric service in which the addition of measurement devices would cause the undesirable event(s) of overpressure and/or under pressure;
  - Relief systems utilizing pressure safety valves and pressure vacuum safety valves associated with pressure vessels and atmospheric vessels.;
  - Venting systems associated with water-treating vessels operating at atmospheric service;
  - Venting systems associated with instrumentation systems (control systems, safety systems); and
  - Sump systems used only to collect water, sand or liquids from drip pans and deck drains that function as a final trap for hydrocarbon liquids in the event of

---

<sup>176</sup> Which states “the overall certainty of the flow meter shall be demonstrated to be within +- 5 percent at 30, 60, 90 percent of the full application scale.



equipment upsets or platform spills, but that are not used as processing devices to treat or skim liquid hydrocarbons as part of a production operation.

- **NTL 2012-N04**, Flaring and Venting Requests, provided guidance for requesting approval to flare or vent natural gas and the discretionary authority of BSEE to approve such requests. This guidance represented a more strict policy and improved BSEE’s conservation enforcement. No flaring or venting without permission is allowed except in limited circumstances, and avoidance of lost revenue was not considered a justifiable reason to flare or vent unless otherwise authorized by BSEE regulation. The only allowable exceptions will be made on a case-by-case basis at BSEE’s discretion, and include:
  - When the BSEE Director determines the flaring or venting is in the national interest, such as when a major hurricane causes widespread and catastrophic gas infrastructure damage, leading to significant declines in national oil production and rapidly escalating oil prices;
  - When the operator demonstrates to the Regional Supervisor’s satisfaction that production from the well completion would likely be permanently lost if the well is shut in; or
  - When the operator demonstrates to the Regional Supervisor’s satisfaction that short-term flaring or venting would likely yield a smaller volume of lost natural gas than if the facility were shut in and restarted later (with flaring and venting necessary to restart the facility).

As of now, request to flare/vent gas are denied unless absolutely necessary for reasons such as national interest, safety, maximize oil recovery, etc. and violations could result in civil and/or criminal penalties. 30 CFR §250.1160. When considering requests to approve flaring or venting, BSEE does not consider avoidance of lost revenue as a reason to justify flaring or venting and any requests based on the need to install gas transportation or conditioning equipment will not be approved unless the cost of installing the equipment makes the entire project, including oil produced from the facility, uneconomic. BSEE, Conservation Enforcement of Oil and Gas Resources on the Outer Continental Shelf, Bureau of Safety and Environmental Enforcement, Sept. 28, 2012 (“BSEE Conservation Enforcement”).

BSEE notes that approval of requests had become more challenging in recent years due in part, to the deepwater facilities and the sizeable flaring and venting volumes that can occur when pieces of equipment on these facilities break down. BSEE Conservation Enforcement. Because of the enormous production capacities of these facilities, decisions to approve or deny flaring at these deepwater facilities impact a significantly larger than normal volume of national resources and therefore the stability of the Nation’s immediate and long-term energy supply. *Id.*

BSEE also conducted an internal review of regulations following the events of the Deepwater Horizon facility in April 2010, An Internal Review of BSEE Regulations Thirty Months After Macondo, Oct. 2012 (“BSEE Internal Review”), which noted significant areas for improvement in regulatory oversight with regards to flaring and venting:

- Record keeping and reporting can be improved since there are numerous references to reports, requests, approvals, communications, and records which are periodic (such as monthly) or based on a trigger event specified or implied. BSEE noted that triggers do not always appear to be concise events and that some records appear to only be maintained at the facility. Thus if there is a major incident where the offshore rig is lost or damaged, key records could be lost in whole or part or could be incomplete relative to regulatory intent. If every record is electronic (or an electronic image is preserved), presumably the owner could or should have separate records (as should BSEE if everything is filed properly and retained). BSEE Internal Review at 69.
- A wide variety of technical and jurisdictional issues (Subparts K, L and M) related to oil and gas measurements should be reviewed and probably revised from the perspective of providing a uniform and consistent approach to these kinds of issues. For example, the accuracy requirements of a particular measuring device should be consistent with the overall accuracy desired from the overall measurement program. BSEE Internal Review at 6-7, 69.
- Technologies which may accommodate broader flow ranges should be reviewed and evaluated. BSEE Internal Review at 7.
- Meter Security: While seals and a seal program assures some level of tamper indication, there is no absolute assurance that tampering cannot occur, and as a result, emphasis should be placed on training seal inspectors. BSEE Internal Review at 7 (noting a practiced person using common tools and supplies can circumvent seals in only a few minutes).

**BID-2015-G070**, *Standard Operating Procedures for Processing and Issuing Decisions Regarding Flaring, Venting, and Burning Requests; Requests to Produce Within 500-ft of Lease/Unit Boundary; Gas Cap Production Requests; and Downhole Commingling Requests*, August 31, 2015, governs procedures for use by Resource Conservation Section (RCS) personnel in processing flaring, venting, and burning requests. The BID notes that requests to flare or vent beyond allowed thresholds should be denied unless an exception outlined in NTL No. 2012-N04 applies. For exception one to apply – national interest – direction must be given from top BSEE management. For exception two to apply – permanent loss of production – RCS personnel will 1) examine the well completion history to determine if there is “solid evidence” of increased problems bringing the completion back online after a shut in; 2) evaluate the most recent well test data if the operator is claiming flow assurance concerns; 3) discuss historical flow assurance strategies (in particular looking at the last three times the well(s) were shut in; and 4) determine if a minimum flowrate exists at which the well completion can be produced. For exception 3 to apply – less lost natural gas – RCS personnel will evaluate the historical data (again focusing on the last three instances) and the well test data to confirm that the operator’s requested rates are reasonable and to confirm that high gas/oil ratio (GOR) wells (wells with a GOR of greater than 1500 SCF/STB) are not being produced. The guidance notes that initial flaring/venting approvals should not exceed the time estimated to reach the first milestone. Before an extension to the flaring/venting approval can be granted, a recapitulation report listing progress since the last flaring/venting approval or extension should be supplied by the operator. If significant progress has not been made, additional flaring/venting usually will not be approved, and

extensions should not be made if volumes or conditions change such that the total cumulative volume flared/vented would exceed the restart flare/vent volume.

**BID-2015-G069**, *Guidance and Inspection Procedures RE Documentation Requirements for Flaring or Venting of Low-Volume Flash Gas*, Sept. 1, 2015, provides guidance pertaining to the flaring or venting of low volume flash gas from storage or other low-pressure production vessels, and also provides associated inspection procedures.

- Reporting requirements in §250.1163 state that operators must prepare and maintain records for all gas flared and vented, not just gas flared or vented during upsets, including records associated with the flaring or venting of low volume, uneconomic-to-recover flash gas from storage or other low-pressure production vessels.
- Requirements of §250.1160(a)(5) state that if flare/vent meters are not required at a facility and no meters are installed, the operator must calculate the estimated volume of flared/vented flash gas by specific methods (e.g. mass balance method) and confirms that although lease use gas is not required to be shown in the flare/vented gas records, operator should be encouraged to do so.
- Inspection procedures detailed to verify compliance with the appropriate regulations:
  - Verify that the operator has determined, by a legitimate method, and recorded the volume of all flash gas flared or vented from storage vessels and other low-pressure production vessel. Note that BSEE Inspectors are not responsible for verifying operator calculations of flared or vented gas.
  - Verify that the recorded volume of gas flared/vented from any facility does not exceed 50 MCF/D (include volumes of flash gas flared/vented from storage vessels and other low-pressure production vessels during normal/routine operations, but do not include volumes from facility upsets) unless approved.
  - Verify that any BSEE approval to routinely flare/vent volumes in excess of 50 MCF/D is maintained with the operator’s flare/vent records on the facility.
- Prompt notification is required if the Inspector observes that the gas volume routinely flared/vented on a facility exceeds 50 MCF/D and the operator is unable to verify approval. Any suspect operator records of flared/vented gas volumes determined to be suspect should also be reported. The Resource Conservation Section is responsible for informing the Office of Natural Resources Revenue (ONRR) when operators flare/vent “avoidably lost” hydrocarbon volumes in noncompliance with the regulations, and operators must pay royalties on the avoidably lost volumes (see 30 C.F.R. § 250.1160(e)). When notifying the Resource Conservation Section in these instances, the BSEE Inspector should provide the Resource Conservation Section with the company name; lease; area/block; volumes flared/vented; and dates flared/vented.
- When such violations occur, BSEE Inspectors should issue an incident of noncompliance, PINC No. P-112, to document that an operator has failed to prepare and maintain flare/vent records for all gas flared or vented from storage vessels or other low-pressure production vessels. The Inspector should include bullet descriptions for each month the operator was in violation of 30 C.F.R. § 250.1160(a)(5).

**BID-2015-P015**, *Procedures Regarding Production Management, Site Security, and Gas Flaring Inspections*, Sept. 8, 2015, provides updated procedures for measurement, site security, and gas flaring inspections performed by OPD personnel and requires that OPD personnel witness a minimum 10% of all oil sales meter provings annually (“proving” means that a meter is tested for accuracy). Each meter proving witnessing as a meter inspection, and each meter proving will be counted as a separate inspection for documentation purposes. When practicable, witnessing of more than one meter proving per day will be scheduled. For gas production, 5% of meter provings should be witnessed. OPD personnel will conduct site security inspections to verify that federal production is protected from loss or theft and that the lessee is in compliance with the site security requirements, and will be conducted on each royalty measurement site in conjunction with calibration or meter proving witnessing. Gas flaring inspections will be conducted by inspection personnel to ensure operator adherence to gas flaring regulations and any conditions of flaring approval.

**BID2015-G036**, *Policy Regarding Flare and Vent Boom and Line Placement and Procedures for Permitting of Underwater Flare Lines*, Sept. 9, 2015, addresses the proper placement of flare and vent booms and lines on offshore facilities helps to manage risk of human injury, property damage, and environmental harm. Improper placement of flare/vent booms and lines may increase the risk of fire or other incident. §§ 250.802(b) and 250.803(a) require all production platforms to comply with the requirements of API RP 14C.<sup>177</sup> The BID provides updated policy regarding regulatory requirements pertaining to acceptable placement of flare/vent booms and lines, and procedures for permitting of underwater piping for flaring atmospheric gas.

- Placement of Underwater Piping for Flaring Atmospheric Gas: The use of underwater piping for flaring atmospheric gas, i.e., underwater flare lines, is acceptable if the piping is of sufficient distance from the platform; however, the outlet to the piping must be at the sea floor a minimum of 250 feet from the platform and in greater than 50 feet of water. BID2015-G036At 4.
- Placement of Flare/Vent Booms: All booms used for flaring or venting flammable gases must be installed vertically upward or such that they ensure safe discharge away from the production facility. Booms terminating vertically down a platform leg, regardless of submerged depth, are not acceptable. BID2015-G036At 4.

**BID2015-G096**, *Standard Operating Procedures for Performing Measurement Inspections, MIU, MAES*, Sept. 15, 2015, provides standard operating procedures for measurement

---

<sup>177</sup> API RP 14C Section C.2.2, Systems for Discharging Gas to Atmosphere, contains specific requirements regarding conducting discharged gas from process components to safe locations for final release to the atmosphere. Placement of flare and vent booms and lines on offshore platforms must comply with the requirements of this section. Section C.2.2.1 states that flare/vent systems should discharge gas to safe “locations where the gas will be diluted with air to below the LEL [lower explosive limit] so it will not be a threat to the facility or where it can be safely burned.” Section C.2.2.3 gives examples of placement options but makes clear the following should be considered in selecting a safe discharge point: a. Personnel safety; b. The discharge volume; c. The location in relation to other equipment, particularly fired vessels or other ignition sources, personnel quarters, fresh air intake systems, and helicopter and boat approaches; d. Prevailing wind direction and, in the case of underwater discharges, the prevailing current.

inspections performed by MIU Inspectors at assigned onshore and offshore facilities to verify lessees are complying liquid hydrocarbon and gas commingling, measurement, and site security regulatory requirements. This BID also requires inspectors to determine onsite if the facility is approved for flare/vent meter installation, required to have meters installed, and then calibrate/verify the meters in accordance with manufacturer recommendations or at least once a year (not to exceed 365 days), whichever is shorter.

## **APPENDIX II**

### **Comparison of EPA and Department of the Interior Regulations as of 2011**

**Table I: EPA and DOI OCS Air Emission Programs** (comparison of selected elements)

Program Elements	EPA Outer OCS Sources Program <sup>a</sup>	DOI
Underlying statutory citation	1990 CAA §328 (42 U.S.C. §7627)	1978 OCSLA §5(a)(8) (43 U.S.C. §1334(a)(8))
Underlying statutory authority	Directs EPA to develop regulations requiring all OCS sources “to attain and maintain Federal and State ambient air quality standards and to comply with the provisions of [the PSD program]”	Directs DOI to develop regulations for compliance with CAA national ambient air quality standards, “to the extent that activities authorized under this subchapter significantly affect the air quality of any State”
Date of implementing regulations	September 4, 1992	March 7, 1980
Jurisdiction	All OCS sources in federal waters, except those west of 87.5 degrees longitude (the western and most of the central Gulf of Mexico) and in the federal OCS off Alaska’s north coast <sup>b</sup>	All OCS sources in Gulf of Mexico federal waters that are west of 87.5 degrees longitude (the western and most of the central Gulf of Mexico) and OCS sources in federal waters off Alaska’s north coast
Framework of requirements	Air emissions permit: PSD and/or Title V  *OCS sources in EPA’s jurisdiction must also submit applicable activity-specific plans per DOI regulations* <sup>c</sup>	Activity-specific plans: Exploration Plan (EP) or Development and Production Plan (DPP)
Emission thresholds for substantive requirements (e.g., BACT)	250 tpy	Two-step determination:  (1) are emissions exempt based on distance from shore? <sup>d</sup>  (2) if not exempt, would emissions “significantly” affect onshore air quality (as determined by modeling)?
Emission monitoring and reporting	Required for Title V permits (100 tpy threshold) and PSD permits (250 tpy threshold)	Monitoring and monthly reporting required regardless of significance determination; <sup>e</sup> but it is uncertain whether this is occurring

Program Elements	EPA Outer OCS Sources Program <sup>a</sup>	DOI
Pollutants subject to thresholds	<p>Per PSD regulations, any “regulated pollutant,”<sup>f</sup> including those with a national ambient air quality standard (NAAQS):</p> <ul style="list-style-type: none"> <li>• Sulfur dioxide (SO<sub>2</sub>)</li> <li>• Particulate matter (PM<sub>2.5</sub> and PM<sub>10</sub>)</li> <li>• Nitrogen dioxide (NO<sub>2</sub>)</li> <li>• Carbon monoxide (CO)</li> <li>• Ozone</li> <li>• Lead</li> <li>• Any pollutant identified as a constituent/precursor to the above (e.g., volatile organic compounds (VOC))</li> <li>• Greenhouse gases (GHG)<sup>g</sup></li> </ul>	<p>Per DOI regulations:</p> <ul style="list-style-type: none"> <li>• SO<sub>2</sub></li> <li>• PM<sub>2.5</sub> and PM<sub>10</sub></li> <li>• Nitrogen oxide (NO<sub>x</sub>)</li> <li>• CO</li> <li>• VOC<sup>h</sup></li> </ul>
Substantive requirements if thresholds met	<p>PSD permit requirements, including:</p> <p>(1) BACT</p> <p>(2) Air quality demonstration/analysis</p>	<p>If affected onshore area is an attainment area: BACT</p> <p>If affected onshore area is a nonattainment area: BACT and reduce all emissions with additional reductions or offsets</p> <p>If more than one area is impacted, the more stringent requirements would apply</p>
Temporary source exemption	<p>If operating for less than two years in a given location, sources are subject to BACT, but not the air quality demonstration and analyses</p>	<p>If operating in one location less than three years, a source must apply BACT to address emissions of any pollutant that would significantly affect the air quality of an onshore area</p>
Other potentially applicable air emission requirements	<p>New Source Performance Standards</p> <p>National Emission Standards for Hazardous Air Pollutants</p> <p>Title V permits</p> <p><i>Coastal Zone Management Act Review per DOI regulations</i></p>	<p>Activity-specific plans must include air emission information, documenting exemption</p> <p>Coastal Zone Management Act Review could potentially lead to air emission modifications</p>



Program Elements	EPA Outer OCS Sources Program <sup>a</sup>	DOI
Time frames for agency review	PSD permit determination within 1 year of complete submittal; Title V permit within 18 months	Activity-specific plans have agency review deadlines (e.g., BOEM must provide an interim/final decision for an EP within 30 days of it being submitted)
Other federal agency involvement	EPA must consult with the applicable Federal Land Manager if a source’s emissions may impact a Class I area	No analogous authority
State implementation	Coastal states may seek authority to implement and enforce EPA requirements for OCS sources in federal waters adjacent to state waters	No analogous authority
Opportunities for public participation	EPA agency must provide a 30-day public comment period when it issues a permit	BOEM must provide a 60-day public comment period for parties to review a DPP
Opportunities for administrative appeal	Environmental Appeals Board: any person can appeal an agency action	No analogous process
Opportunity for legal challenge	CAA provides opportunity for judicial review of agency actions	OCSLA provides opportunity for judicial review of agency actions

**Source:** Prepared by CRS.

- a. Pursuant to CAA Section 328, EPA established two regulatory regimes: one for OCS sources located within 25 miles of a state’s seaward boundary (“inner OCS sources”); another for OCS sources located beyond 25 miles of a state’s water boundary and extending to the boundary of the EEZ (“outer OCS sources”). Requirements for “inner sources” are the same as would be applicable if the source were located in the corresponding onshore area. These requirements will vary by state and whether the corresponding onshore area is an attainment or nonattainment area for regulated pollutants.
- b. P.L. 112-74 (signed by President Obama December 23, 2011) transferred air emission authority from EPA to DOI for OCS sources off Alaska’s north coast.
- c. The DOI activity-specific plans entail multiple provisions, including potential air emission requirements. See Notice to Lessees and Operators 2009-NI 1, “Air Quality Jurisdiction on the OCS,” December 4, 2009.
- d. For all but CO emissions, the exemption formula is:  $E = 33.3D$ . Thus, a source located 30 miles from shore would be exempt if its emissions were above 990 tpy.
- e. This appears to apply regardless of the source’s exempt status or whether the OCS source’s emissions would significantly impact air quality (30 C.F.R. §550.303(k)).
- f. The official term is “regulated NSR [New Source Review] pollutant,” which includes (among others) any pollutant for which a national ambient air quality standard (NAAQS) has been promulgated and any pollutant identified as a constituent or precursor for a regulated NSR pollutant (40 C.F.R. §52.21(b)(50)).
- g. As of January 2, 2011, an OCS source must consider its GHG emissions. These emissions are subject to a different threshold. As of July 1, 2011, new emission sources—not already subject to PSD for other pollutants—would be subject to PSD, if GHG emissions equal or exceed 100,000 tpy of carbon dioxide equivalents (CO<sub>2</sub>e). If an OCS source is already subject to PSD for one or more of the 250 tpy-threshold pollutants, the GHG emission threshold is 75,000 tpy of CO<sub>2</sub>e.
- h. If VOC emissions breach the exemption threshold, they are automatically considered to “significantly” affect onshore air quality.

## **APPENDIX III**

### **Comparison of BLM’s Proposed Rule to Existing Regulation and Rejected Alternatives**

**Table IIa: Proposed Requirements and Alternative Considered**

Source	Distinction Within Source	Proposed Requirements	Alternatives Considered to the Proposed Requirements or Maintaining the Status Quo
Flared (variety of sources)	Oil-well gas (associated gas)	<p>The operator is required to submit information with its APD for a development oil well about anticipated gas volumes and planned disposition of any associated gas.</p> <p>The operator is not permitted to flare gas from a development oil well in excess of 7,200 Mcf/month/well (on average across a lease) for the first year of the rule’s implementation, 3,600 Mcf/month/well for the second year of the rule’s implementation, and 1,800 Mcf/month/well thereafter.</p> <p>The operator is required to meter flared associated gas if greater than 50 Mcf/day, monthly average.</p> <p>Royalty is specified on gas vented and flared during production operations when the well is connected to gas capture infrastructure (including during times of temporary line capacity issues, processing plant maintenance, etc). Royalty is not specified for well completion gas, well testing gas, gas used for production purposes, gas released during emergencies, gas released during liquids unloading, gas vapors emitted from storage tanks, or gas lost from leaks.</p>	Specifying royalty on all lost gas; Alternative flaring limits; Identifying gas capture zones and ordering the capture of gas under certain conditions.
	Well testing	Reduce maximum royalty-free volume limit to 20 MMcf.	None
Well drilling, completions, and well maintenance	None (practically affects all conventional completions and affects hydraulically fractured oil well completions only if the EPA does not finalize Subpart OOOOa)	Require gas to be captured and routed to a sales line, combusted, re-injected, or used for production purposes on site.	Placing the proposed requirements on a subset of the well completions rather than on all well completions.

**Table IIa: Proposed Requirements and Alternative Considered**

Source	Distinction Within Source	Proposed Requirements	Alternatives Considered to the Proposed Requirements or Maintaining the Status Quo
Pneumatic controllers	Continuous, high bleed (practically affects existing controllers)	Replace high-bleed continuous controllers with low-bleed controllers, with some exceptions.	None
Pneumatic pumps	Chemical injection pumps (practically affects existing pumps, and affects new pumps only if the EPA does not finalize Subpart OOOOa)	Replace pumps that use gas with solar powered units, with some exceptions. Operators are required to reduce releases from chemical injection pumps where feasible.	None
Gas well liquids unloading	None	Various operational and reporting requirements when conducting liquids unloading without an automated system; No well purging for wells drilled after the effective date.	Placing plunger lift requirements on existing wells
Oil and condensate storage tanks	None (practically affects existing uncontrolled tanks)	Require combustion (at a minimum) if VOC emissions exceed 6 tpy, with some exceptions.	Requiring combustion (at a minimum) at different VOC threshold; Placing VRU requirements on higher volume tanks.
Leaks	None (practically affects existing wellsite facilities, and affects new wellsite facilities only if the EPA does not finalize Subpart OOOOa)	Requires the operator to implement an LDAR program, initially requiring semi-annual inspections (with the inspection frequency adjustable depending on the number of leaks identified during successive inspections). The operator must use an infrared camera, portable analyzer (only if operator has less than 500 wells), or other method approved by the BLM. The operator must repair all leaks that it identifies. The BLM may approve an operator’s LDAR or monitoring programs.	Alternative inspection frequencies and mechanisms for adjusting the frequencies, including different frequencies for marginal wells.

**Table IIb: Proposed Requirements and Interaction with EPA’s Enacted and Proposed Regulations**

<b>Source</b>	<b>EPA Subpart OOOO (Enacted)</b>	<b>EPA Subpart OOOOa (Proposed)</b>	<b>Practical Impact of BLM’s Proposed Regulation</b>
Flaring during normal production operations	None	None	Would regulate operations.
Well completions and workovers	Regulates hydraulically fractured gas well completions	Would regulate hydraulically fractured oil well completions	Would regulate completions except for hydraulically fractured gas wells and hydraulically fractured oil wells if Subpart OOOOa is finalized.
Pneumatic controllers	Regulates new pneumatic controllers	None	Would regulate pneumatic controllers installed before Subpart OOOO’s implementation.
Pneumatic Pumps	None	Would regulate new pneumatic pumps	Would regulate pneumatic pumps except for new pumps if Subpart OOOOa is finalized.
Gas well liquids unloading	None	None	Would regulate operations.
Oil and condensate storage tanks	Regulates new or modified tanks	None	Would regulate tanks existing before Subpart OOOO’s implementation.
Leaks	None	Would regulate new and modified wellsites	Would regulate wellsites except for new or modified wellsites if Subpart OOOOa is finalized.

## **APPENDIX IV**

### **Comparison of United States Offshore and Onshore Regulation**

**Table III: Comparison of USA Onshore and Offshore Regulation**

	USA - Offshore	USA - Onshore
<b>Regulator</b>	Bureau of Safety and Environmental Enforcement (BSEE)	Bureau of Land Management (BLM)
<b>Authority</b>	OCS Lands Act	Mineral Leasing Act
<b>Regulations Exist?</b>	30 C.F.R. Part 250, Subpart K	43 C.F.R. Parts 3100, 3600, Proposed 43 C.F.R. Parts 3178 and 3179
<b>Additional Guidance</b>	Notices to Lessees (NOTL) and Bureau Interim Directives (BID)	NTL
<b>When is flaring/venting allowed?</b>	<p>Flaring and venting is not allowed without prior approval unless an exception in 250.1160(a) applies. Regardless of those exceptions, operators must not flare or vent gas over the volume approved in the Development Operations Coordination Document (DOCD) or your Development and Production Plan (DPP) submitted to BOEM. The Regional Supervisor may establish alternative approval procedures to cover situations when operators cannot contact the BSEE office, such as during non-office hours, and may specify alternative limits such as a volume limit or shorter time limits, in order to prevent air quality degradation or loss of reserves. If flaring or venting is done without prior approval, and the Reg'l Super determines the operator was negligent or could have avoided flaring or venting the gas, the hydrocarbons will be considered avoidably lost or wasted. Royalties will then be due on the loss or waste according to 30 CFR part 1202. Any gas or liquid hydrocarbons will be valued as avoidably lost or wasted under the provisions of 30 CFR part 1206. Fugitive emissions from valves, fittings, flanges, pressure relief valves or similar components do not require approval under this subpart unless specifically required by the Regional Supervisor. When considering requests to approve flaring or venting, BSEE does not consider avoidance of lost revenue as a reason to justify flaring or venting and any requests based on the need to install gas transportation or conditioning equipment will not be approved unless the cost of installing the equipment makes the entire project, including oil produced from the facility, uneconomic.</p>	<p>NTL-4A prohibits venting or flaring of gas well gas, and it prohibits venting or flaring of oil well gas unless approved in writing by the "Supervisor." Proposed rules would set strict limits on volumes: Flaring from development oil wells would be limited to the following amounts:</p> <ul style="list-style-type: none"> <li>• 7,200 Mcf/well/month on average across the lease for the first year of the rule's implementation;</li> <li>• 3,600 Mcf/well/month on average across the lease for the second year of the rule's implementation; and</li> <li>• 1,800 Mcf/well/month on average across the lease thereafter. As a result, operators would no longer have to obtain permission for flaring on a case-by-case basis, provided they stay within the proposed prescribed limit. However, BLM would retain the authority to allow higher rates of flaring in specific circumstances, where adhering to the proposed flaring limit would impose such costs as to cause the operator to cease production and abandon significant recoverable oil reserves under the lease.</li> </ul>
<b>Exceptions</b>	<p>(1) When the gas is lease use gas (produced natural gas which is used on or for the benefit of lease operations such as gas used to operate production facilities) or is used as an additive necessary to burn waste products, such as H<sub>2</sub>S, in which case the volume of gas flared/vented may not exceed the amount necessary for its intended purpose. Burning waste products may require approval under other regulations.</p> <p>(2) During the restart of a facility that was shut in because of weather conditions, such as a hurricane. Flaring or venting may not exceed 48 cumulative hours without approval.</p> <p>(3) During the blow down of transportation pipelines downstream of the royalty meter. The location, time, volume and reason must be given in writing within 72 hours after the incident is over, and additional approval may be necessary.</p> <p>(4) During the unloading or cleaning of a well, drill-stem testing, production testing, other well-evaluation testing, or the necessary blow down to perform these procedures, and there may not be more than 48 cumulative hours of flaring or venting per unloading or cleanup or testing operation on a single completion without prior approval.</p>	<p>Short term venting and flaring is authorized and royalty-free without the need for approval under specified circumstances, including during emergencies, well purging and evaluation tests, and initial production tests. Venting or flaring is authorized during:</p> <p>1) Emergency situations, such as equipment failures, for up to 24 hours per incident and up to 144 cumulative hours per lease per month.</p> <p>2) The unloading or cleaning up of a well during drillstem, producing, routine purging, or evaluation tests, not exceeding a period of 24 hours.</p> <p>3) Initial well evaluation tests, for up to 30 days or up to 50 million cubic feet (MMcf) of gas, whichever occurs first. 81 F.R. 6628.</p>

Table III: Comparison of USA Onshore and Offshore Regulation

(5) When properly working equipment yields flash gas (natural gas released from liquid hydrocarbons as a result of a decrease in pressure, an increase in temperature, or both) from storage vessels or other low-pressure production vessels, and you cannot economically recover this flash gas. No more than an average of 50 MCF per day in any calendar month may be vented or flared without prior approval.

(6) When the equipment works properly but there is a temporary upset condition, such as a hydrate or paraffin plug. (i) For oil-well gas and gas-well flash gas (natural gas released from condensate as a result of a decrease in pressure, an increase in temperature, or both), flaring/venting may not exceed 48 continuous hours without approval. (ii) For primary gas-well gas (natural gas from a gas well completion that is at or near its wellhead pressure; this does not include flash gas), flaring/venting may not exceed 2 continuous hours without approval. (iii) Cumulative flaring/venting may not exceed 144 hours during a calendar month without approval.

(7) When equipment fails to work properly, during equipment maintenance and repair, or when you must relieve system pressures. (i) For oil-well gas and gas-well flash gas, no more than 48 continuous hours of flaring or venting is allowed without approval. (ii) For primary gas-well gas, no more than 2 continuous hours of flaring or venting is allowed without approval. (iii) No more than 144 cumulative hours is allowed during a calendar month without approval. (iv) The continuous and cumulative hours allowed under this paragraph may be counted separately from the hours under paragraph (a)(6) of this section.

Exemptions to proposed limits would include those above (current limits) as long as the operator has complied with the proposed requirements to minimize such losses, 2) gas lost in the normal course of well drilling and well completion; 3) well tests; 4) emergencies, as would be defined in the regulations; and 5) gas flared from exploration or wildcat wells, or delineation wells (wells drilled to define the boundaries of a mineral deposit). *Id.* In making its determination, the BLM would consider the costs of capture, and the costs and revenues of all oil and gas production on the lease. create a 2-year renewable exemption from the flaring limit, available only for certain existing leases that are located a significant distance from gas processing facilities and flaring at a rate well above the proposed flaring limit

NOTL 2012-N04 provide the following additional exceptions: When the BSEE Director determines the flaring or venting is in the national interest, such as when a major hurricane causes widespread and catastrophic gas infrastructure damage, leading to significant declines in national oil production and rapidly escalating oil prices; o When the operator demonstrates to the Regional Supervisor’s satisfaction that production from the well completion would likely be permanently lost if the well is shut in; or o When the operator demonstrates to the Regional Supervisor’s satisfaction that short-term flaring or venting would likely yield a smaller volume of lost natural gas than if the facility were shut in and restarted later (with flaring and venting necessary to restart the facility). For exception one to apply – national interest – direction must be given from top BSEE management. For exception two to apply – permanent loss of production – RCS personnel will 1) examine the well completion history to determine if there is “solid evidence” of increased problems brining the completion back online after a shut in; 2) evaluate the most recent well test data if the operator is claiming flow assurance concerns; 3) discuss historical flow assurance strategies (in particular looking at the last three times the well(s) were shut in; and 4) determine if a minimum flowrate exists at which the well completion can be produced. For exception 3 to apply – less lost natural gas – RCS personnel will evaluate the historical data (again focusing on the last three instances) and the well test data to confirm that the operator’s requested rates are reasonable and to confirm that high gas/oil ratio (GOR) wells (wells with a GOR of greater than 1500 SCF/STB) are not being produced. The guidance notes that initial flaring/venting approvals should not exceed the time estimated to reach the first milestone. Before an extension to the flaring/venting approval can be granted, a recapitulation report listing progress since the last flaring/venting approval or extension should be supplied by the operator. If significant progress has not been made, additional flaring/venting usually will not be approved, and extensions should not be made if volumes or conditions change such that the total cumulative volume flared/vented would exceed the restart flare/vent volume.

Approval Criteria

BLM allows approval of an application for the venting or flaring of oil well gas if justified either by the submittal of (1) an evaluation report supported by engineering, geologic, and economic data demonstrating that the expenditures necessary to market or beneficially use such gas are not economically justified and that conservation of the gas, if required, would lead to the premature abandonment of recoverable oil reserves and ultimately to a greater loss of equivalent energy than would be recovered if the venting or flaring were permitted to continue or (2) an action plan that will eliminate venting or flaring of the gas within 1 year from the date of application. “When evaluating the feasibility of requiring conservation of the gas, the total leasehold production, including both oil and gas, as well as the economics of a field wide plan shall be considered . . . in determining whether the lease can be operated successfully if it is required that the gas be conserved.” 81 F.R. 6628.



**Table III: Comparison of USA Onshore and Offshore Regulation**

<b>Flaring or Venting for Extended Time Periods</b>	<p>You must request and receive approval from the Regional Supervisor to flare or vent gas for an extended period of time. The Regional Supervisor will specify the approved period of time, which will not exceed 1 year. The Regional Supervisor may deny your request if it does not ensure the conservation of natural resources or is not consistent with National interests relating to development and production of minerals of the OCS. The Regional Supervisor may approve your request for one of the following reasons: (a) You initiated an action which, when completed, will eliminate flaring and venting; or (b) You submit to the Regional Supervisor an evaluation supported by engineering, geologic, and economic data indicating that the oil and gas produced from the well(s) will not economically support the facilities necessary to sell the gas or to use the gas on or for the benefit of the lease.</p>	<p>Under proposed rules, gas must be metered if flaring exceeds 50 Mcf/day, Reg. Impact Analysis at 25, and estimations would be allowed as opposed to measurement of small volumes of lost gas since the agency concluded that any additional accuracy provided by meters may not be justified by the cost</p>
<b>Measurement</b>	<p>If facility processes more than an average of 2,000 bopd during May 2010, you must install flare/vent meters within 180 days after May 2010. If facility processes more than an average of 2,000 bopd during a calendar month after May 2010, install flare/vent meters must be installed within 120 days after the end of the month in which the average amount of oil processed exceeds 2,000 bopd and Reg'l Super must be informed when the facility begins to process more than an average of 2,000 bopd in a calendar month. Meters must measure all flared and vented gas within 5 percent accuracy. Meters must be calibrated regularly, in accordance with the manufacturer's recommendation, or at least once every year, whichever is shorter. Meters must be used and maintained for the life of the facility.</p>	<p>Under proposed rules, gas must be metered if flaring exceeds 50 Mcf/day, Reg. Impact Analysis at 25, and estimations would be allowed as opposed to measurement of small volumes of lost gas since the agency concluded that any additional accuracy provided by meters may not be justified by the cost</p>
<b>Reporting</b>	<p>NOTLE 2012-N03 clarified meter accuracy standards since the currently available technologies may not achieve the high accuracy standard required over the full range of possible flow rates. Meters installed should be capable of measurement within 5 percent accuracy over the range from 50 MCF per day to a maximum flow rate expected in the most probable high rate emergency flaring scenarios, if achievable using standard applications of currently available metering technologies. If nothing can meet these requirements under a site's particular flow conditions, operators must install the best meter technology available and may satisfy the requirement by meeting the uncertainty standard given in the API MPMS Chapter 14, Section 10.5.1. Some limited exceptions would apply for 1) venting systems associated with vessels that operate in atmospheric service in which the addition of measurement devices would cause the undesirable event(s) of overpressure and/or under pressure; 2) relief systems utilizing pressure safety valves and pressure vacuum safety valves associated with pressure vessels and atmospheric vessels; 3) venting systems associated with water-treating vessels operating at atmospheric service; 4) venting systems associated with instrumentation systems (control systems, safety systems); and 5) sump systems used only to collect water, sand or liquids from drip pans and deck drains that function as a final trap for hydrocarbon liquids in the event of equipment upsets or platform spills, but that are not used as processing devices to treat or skim liquid hydrocarbons as part of a production operation.</p>	<p>All hydrocarbons produced from a well completion, including all gas flared, gas vented, and liquid hydrocarbons burned must be reported in accordance with 30 CFR 1210.102. Amount of gas flared and the amount of gas vented separately. Operators may classify and report gas used to operate equipment on the lease, such as gas used to power engines, instrument gas, and gas used to maintain pilot lights, as lease use gas. Where are required, the amount of gas flared and vented at each of those facilities must be reported separately from those facilities that do not require meters and separately from other facilities with meters. Where meters are not required, gas flared and vented may be reported on a lease or unit basis. Gas flared and vented from multiple facilities on a single lease or unit may be reported together.</p>

**Table III: Comparison of USA Onshore and Offshore Regulation**

<b>Recordkeeping</b>	<p>Records must be prepared and maintained detailing gas flaring, gas venting, and liquid hydrocarbon burning for each facility for 6 years and kept onsite at facility for the first 2. Records must be made available for inspection by BSEE representatives. After 2 years, must have them available upon request. Records must include, at a minimum: (i) Daily volumes of gas flared, gas vented, and liquid hydrocarbons burned; (ii) Number of hours of gas flaring, gas venting, and liquid hydrocarbon burning, on a daily and monthly cumulative basis; (iii) A list of the wells contributing to gas flaring, gas venting, and liquid hydrocarbon burning, along with gas-oil ratio data; (iv) Reasons for gas flaring, gas venting, and liquid hydrocarbon burning; and (v) Documentation of all required approvals. If meters are required, meter recordings must be maintained for 6 years. These recordings must be kept on the facility for 2 years and available for inspection, after which time they must be maintained, available for inspection and copies made upon request but may not be kept at the facility. Recordings must include begin times, end times and volumes for all incidents. Flare/vent meter calibration and maintenance records must be maintained on the facility for 2 years. If any flaring or venting of gas, or burning of liquid hydrocarbons, required written or oral approval, you must submit documentation to the Regional Supervisor summarizing the location, dates, number of hours, and volumes of gas flared, gas vented, and liquid hydrocarbons burned under the approval.</p>
<b>H2S Requirements</b>	<p>No venting of gas containing H2S is allowed except for minor releases during maintenance and repair activities that do not result in a 15-minute time-weighted average atmosphere concentration of H2S of 20 ppm or higher anywhere on the platform. Flaring allowed only if requirements of §§250.1160, 250.1161, 250.1163 are met along with the following additional requirements: (1) For safety or air pollution prevention purposes, the Regional Supervisor may further restrict the flaring of gas containing H2S. The Regional Supervisor will use information provided in the lessee's H2S Contingency Plan (§250.490(f)), Exploration Plan, DPP, DOCD submitted to BOEM, and associated documents to determine the need for restrictions; and (2) If the Regional Supervisor determines that flaring at a facility or group of facilities may significantly affect the air quality of an onshore area, the Regional Supervisor may require an air quality modeling analysis, under 30 CFR 550.303, to determine the potential effect of facility emissions. The Regional Supervisor may require monitoring and reporting, or may restrict or prohibit flaring, under 30 CFR 550.303 and 30 CFR 550.304. (c) The Regional Supervisor may require monthly reports of flared and vented gas containing H2S. Each report must contain, on a daily basis: 1) the volume and duration of each flaring and venting occurrence; 2) H2S concentration in the flared or vented gas; and 3) calculated amount of SO2 emitted.</p>
<b>Inspections</b>	<p>Inspection procedures detailed to verify compliance with the appropriate regulations. Inspectors will 1) Verify that the operator has determined, by a legitimate method, and recorded the volume of all flash gas flared or vented from storage vessels and other low-pressure production vessel. Note that BSEE Inspectors are not responsible for verifying operator calculations of flared or vented gas. 2) Verify that the recorded volume of gas flared/vented from any facility does not exceed 50 MCF/D (include volumes of flash gas flared/vented from storage vessels and other low-pressure production vessels during normal/routine operations, but do not include volumes from facility upsets) unless approved. 3) Verify that any BSEE approval to routinely flare/vent volumes in excess of 50 MCF/D is maintained with the operator's flare/vent records on the facility.</p> <p>o requirements used to verify compliance during inspections are currently specified in three BLM onshore orders issued pursuant to regulation. Onshore Order Number 3 specifies requirements for the minimum standards for site security by ensuring that oil and gas produced from federal onshore leases are properly handled to prevent theft and loss and enable accurate measurement. Included in the order's requirements is that the operator is to submit a diagram of the facility that includes the locations of key infrastructure, such as metering equipment. Onshore Order Number 4 specifies requirements for oil measurement. Onshore Order Number 5 specifies requirements for gas measurement. BLM's petroleum engineer technicians are responsible for conducting production inspections.</p>

**Table III: Comparison of USA Onshore and Offshore Regulation**

OPD personnel must witness a minimum 10% of all oil sales meter provings annually. Each meter proving witnessing as a meter inspection, and each meter proving will be counted as a separate inspection for documentation purposes. When practicable, witnessing of more than one meter proving per day will be scheduled. For gas production, 5% of meter provings should be witnessed. OPD personnel will conduct site security inspections to verify that federal production is protected from loss or theft and that the lessee is in compliance with the site security requirements, and will be conducted on each royalty measurement site in conjunction with calibration or meter proving witnessing. Gas flaring inspections will be conducted by inspection personnel to ensure operator adherence to gas flaring regulations and any conditions of flaring approval. Inspectors at assigned onshore and offshore facilities to verify lessees are complying liquid hydrocarbon and gas commingling, measurement, and site security regulatory requirements. This BID also requires inspectors to determine onsite if the facility is approved for flare/vent meter installation, required to have meters installed, and then calibrate/verify the meters in accordance with manufacturer recommendations or at least once a year (not to exceed 365 days), whichever is shorter.

Production inspections typically consist of four key activities: (1) reviewing 6 months of production records to look for any anomalies, (2) assessing the physical conditions of the production area by looking for refuse or any leaking equipment, (3) verifying that the company-submitted diagram of the facility reflects what is actually at the site, and (4) examining a sample of both oil and gas measurement operations.

**Violations**

When such violations occur, BSEE Inspectors should issue an incident of noncompliance, PINC No. P-112, to document that an operator has failed to prepare and maintain flare/vent records for all gas flared or vented from storage vessels or other low-pressure production vessels. The Inspector should include bullet descriptions for each month the operator was in violation of 30 C.F.R. § 250.1160(a)(5). Prompt notification is required if the Inspector observes that the gas volume routinely flared/vented on a facility exceeds 50 MCF/D and the operator is unable to verify approval. Any suspect operator records of flared/vented gas volumes determined to be suspect should also be reported. The Resource Conservation Section is responsible for informing the Office of Natural Resources Revenue (ONRR) when operators flare/vent “avoidably lost” hydrocarbon volumes in noncompliance with the regulations, and operators must pay royalties on the avoidably lost volumes (see 30 C.F.R. § 250.1160(e)). When notifying the Resource Conservation Section in these instances, the BSEE Inspector should provide the Resource Conservation Section with the company name; lease; area/block; volumes flared/vented; and dates flared/vented.

**Permitting**

To secure a permit to drill on offshore leases, the operator must submit an application for a drilling permit to the appropriate BSEE district office, where it is first reviewed for completeness and then a technical review is conducted for conformance with all applicable regulations. After all reviewing is complete, a district engineer may approve the permit. Once drilling is completed—and if the operator discovers that oil and gas can be economically produced from the well—the operator may be required to submit an application to begin production that describes, among other things, how oil and gas will be measured. If the application is approved, a facility measurement point is assigned, which is an identifier for each location where oil and gas produced will be measured for royalty purposes, a requirement that BLM does not have

To secure a permit to drill on onshore leases, a company must submit an application for a drilling permit to the appropriate BLM field office where It is evaluated for conformity with relevant BLM land use plan for the area and applicable laws and regulations, including those focused on protecting the environment. In evaluating an application for a drilling permit, an engineer reviews technical aspects of the proposed well design and drilling practices. In most cases, there is no need to specifically approve any oil or gas measurement equipment if a company plans to use metering technologies addressed by BLM’s measurement regulations. However, at a company’s request, BLM will also consider whether to approve a variance from regulations governing the use of alternative metering technologies. After a drilling permit is approved, the company may drill the well and commence production but must file within 60 days of drilling a diagram of the facility that accurately reflects the relative positions of the production equipment, piping, and metering systems.

BLM proposed rules require operators to submit information about anticipated gas production and planned gas disposition in conjunction with the Application for Permit to Drill. prior to drilling a new development oil well, an operator would have to evaluate the opportunities and prepare a plan to minimize waste of associated gas from that well, and the operator would need to submit this plan along with the Application for Permit to Drill or Reenter (APD). The BLM proposes to require submission of a plan with specific content, to ensure that operators have carefully considered and planned for gas capture prior to drilling.

## APPENDIX II

# METHANE EMISSION REDUCTION TECHNOLOGY BRIEFINGS

THIS REPORT WAS INADVERTENTLY DISSEMINATED IN THE PUBLIC DOMAIN/ONLINE SINCE 07/2021 WITHOUT A DISCLAIMER. DISCLAIMER HAS BEEN ADDED  
– “THIS INFORMATION IS DISTRIBUTED SOLELY FOR THE PURPOSE OF PEER REVIEW UNDER APPLICABLE INFORMATION QUALITY GUIDELINES. IT HAS NOT BEEN FORMALLY DISSEMINATED BY BSEE. IT DOES NOT REPRESENT AND SHOULD NOT BE CONSTRUED TO REPRESENT ANY AGENCY DETERMINATION OR POLICY.”



## Appendix II: Methane Emission Reduction Technology Briefings

Each section in this appendix provides an overview of the technology discussed, including a description and discussions about applicability, operation and maintenance, and emission reduction potential. The economic analyses of these technologies are covered in the Cost-Benefit Analysis section of the main report. The exhibit numbers and references in each section pertain only to that individual technology section.

- [Maintain Pressure](#) in Standby Compressor
- [Compressors Blowdown Recovery](#) as Fuel Gas
- [Install Static Seals](#) on Compressor Rods
- [Install Ejectors](#) on Compressor Blow-Down Vent Lines
- [Recover Gas from Pipeline Pigging Operations](#)
- [Capturing Gas When Depressurizing a Pipeline](#)
- Pipeline [Purging with Nitrogen](#)
- [Reduced Emission Completions](#)
- Well Unloading—[Foaming Agents](#)
- Well Unloading—[Velocity Tubing](#)
- [Install Flare System](#)
- Liquid Removal Through [Gas Lift System](#)
- [Microturbines](#) Use Flare Gas for Power Generation
- Well Unloading Through [Electric Submersible Pumps](#)
- [Downhole Jet Pump for Well Unloading](#)
- [Monitor and Repair Leaking Flare/Vent Control Valves](#)
- [Install Redundant Compressors](#)

# Maintain Pressure in Standby Compressor

[Return](#)

## Technology Overview

In the offshore production industry, compressors are used to recover flash gas (natural gas) from production wells and to export it through pipelines. Compressors must periodically be taken offline for maintenance, operational standby, or emergency shutdown testing; and as a result, methane may be released into the atmosphere from a number of sources. When compressor units are shut down, typically, the high-pressure gas remaining within the compressors and the associated piping between isolation valves (see Exhibit 1) is “blown down” to the flare or to the atmosphere. In addition to blow-down emissions, a depressurized system may continue to leak gas due to faulty or improperly sealed unit isolation valves, which are estimated to leak at an average rate of 1.4 thousand standard cubic feet (Mcf) per hour.

Changes in operating practices and in the designs of blow-down systems can save money and significantly reduce methane emissions. While a compressor must be blown down before it can be restarted, the blow down can occur either after initial shutdown or just before restart. Keeping systems fully or partially pressurized during an extended compressor shutdown can reduce venting and flaring emissions by preventing leaks through the unit isolation valves. Though pressurized systems may also leak from the closed blow-down valve and from reciprocating compressor rod packings (or centrifugal compressor seals), total emissions can be significantly reduced. The leakage rate from pressurized compressors is estimated to be smaller, totaling 0.45 Mcf/hour versus 1.4 Mcf/hour for a depressurized system.

The number of times a compressor is taken offline for normal operations depends on its operating mode. Some compressors are considered “base load”; these compressors operate most of the time and might be taken offline only a few times per year with a downtime of 2–5%.

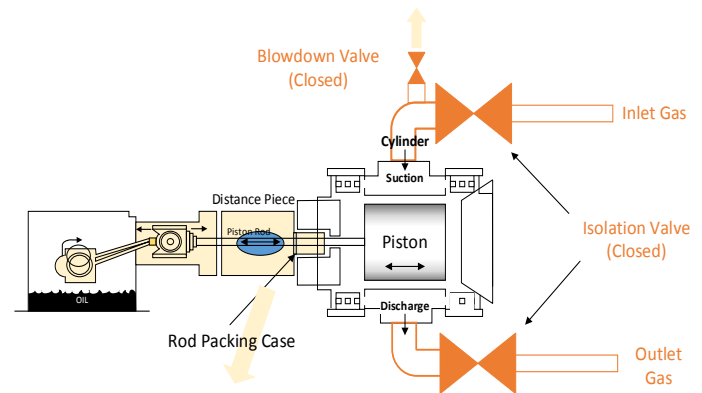

**Exhibit 1: Typical Compressor Isolation Valves (side view cut in half).**

If an offline compressor is shut down because it is a standby unit (not needed for current demand), then unit isolation valves may not be verified to completely seal like they would be in the case of a Lock-out/Tag-out for repair. Unit isolation valves are periodically maintained to reduce leakage, but the limited accessibility of such valves can result in increased leakage between scheduled maintenance.

The largest source of methane emissions that are associated with taking compressors offline stems from depressurizing the system by venting gas that remains within the compressor and associated piping. The gas volume released during a compressor blow down depends on several factors, including the size of the compressor, the internal pressure, and the piping and separator volumes contained between unit isolation valves.

On average, a single blow down will release approximately 15Mcf of gas to the atmosphere.

If the compressor is kept pressurized while offline, emissions from compressor rod packings, compressor seals, and blow-down valves can be observed. Seals on compressor piston rods will leak during normal operations, but this leakage increases approximately 50% (to about 75 scfh per rod, or 0.3 Mcf/hour, per four-cylinder compressor) when a compressor is idle with a fully pressurized suction line. Leaks occur through gaps between the seal rings and their support cups, which are closed by the dynamic movement of the piston rod and lubricating oil (see EPA’s Energy Gas Star *Lessons Learned: [Reducing Methane Emissions from Compressor Rod Packing](#)*). Dry gas centrifugal compressor seals are less likely to leak while the unit is pressurized, unless they are damaged or fouled. Vent and flare system valves (blow-down valves) can also leak from pressurized systems at a rate of 150 scfh.

Leakage from a compressor seal and closed blow-down valve will increase for a pressurized system, but is still less than the anticipated leakage at the unit isolation valve for a depressurized system. Operators report that total fugitive revised to enable maintaining pressure in the standby compressor.

gas emissions can be reduced by as much as 68%, to approximately 0.45 Mcf/ hour for a pressurized compressor.

### Operation and Implementation

Safety is a priority when designing and operating offshore production facilities. Maintaining gas pressure on idle compressors and valves causes increased leakage through the equipment inside the compressor station. The appropriate precautions must be taken within the facility for gas detection, the potential energy hazards of high-pressure vessels, and adequate ventilation to prevent accumulation of leaked gases. Installing static seals on compressor rods and maintaining and selecting the appropriate valves can minimize this leakage and the associated safety concerns.

Appropriate valve selection and maintenance of the unit isolation valve seal integrity of can eliminate much of the annual emission from typical shutdown and blow-down practice. Repairs on these valves are expensive in terms of material and labor, as well as the cost of gas emissions and losses that result from depressurizing the entire station to access these valves.

To modify blow-down practices, programming logic for the compressor will need to be

Applicable Application(s)	
<input checked="" type="checkbox"/>	New Construction
<input checked="" type="checkbox"/>	Retrofit
Applicable Modification(s)	
<input type="checkbox"/>	Hardware/Equipment
<input checked="" type="checkbox"/>	Process
Applicable Structure(s)	
<input type="checkbox"/>	Well-Only Platforms
<input checked="" type="checkbox"/>	Fixed Platforms
<input checked="" type="checkbox"/>	Floating Platforms (SPAR/TLP/CT/Semi-Sub)
Applicable Equipment Type(s)	
<input checked="" type="checkbox"/>	Flare
<input checked="" type="checkbox"/>	Cold Vent



## Applicability

The opportunity to maintain pressure on the standby compressor system is mainly viable when the compressor will be offline for days or weeks and not isolated for maintenance.

Offshore, this happens if there is redundant compressor capacity and a unit is placed in standby mode for days or weeks. This is more common on new facilities built for a peak production rate that will not be realized for some time or on older facilities where production has declined significantly.

If none of the valves associated with the compressor system leak, then leaving the compressor pressurized would lead to the same emissions as blowing down the unit on shutdown. If the isolation valves don't leak and the blow-down valve does leak, the compressor will blow itself down over a longer period of time, and emissions will be essentially the same.

The benefit of this change in procedure (and possibly programming) is only realized if the unit isolation valves leak into the depressurized compressor and through the open blow-down valve.

A reasonable test of the isolation valves would be to close the blow-down valve after the compressor is depressurized. Monitor the compressor case pressure to determine whether the valves leak sufficiently to

justify maintaining pressure in the compressor case during extended standby periods.

## Emission Reduction Potential

When identifying blow-down alternatives, it is important to consider maintaining pressure on the compressor, either on its own or in combination with other blow-down alternatives. Installing static seals could provide added gas savings in conjunction with maintaining the compressor pressure by limiting fugitive gas emissions.

Determining the quantity and value of methane emissions will require an understanding of the leakage rate of unit isolation valves. Unit valve leaks can be measured at the blow-down vent using handheld measuring devices. Leak rates generally increase since the last maintenance of the valves. A default value of 1,400 scfh is used in this analysis.

When compressor pressure is maintained, leakage occurs at the compressor rod packing (0.3 Mcf/h per compressor) and at the blow-down valve (0.15 Mcf/h), totaling approximately 0.45 Mcf/h when the compressor is fully pressurized.

Most of this information is easily accessible from operating records and nameplate specifications, or can be estimated.

Uptime	45%	%
Downtime for Mtc	10%	%
Stand-by time	45%	%
S/B Hours/Yr	3942	Hours
Leakage when depressured	1.4	MCFH
Leakage when pressurized	0.45	MCFH
Emission Reduction/hr	0.95	MCFH
Emission Reduction / yr	3745	MCF
Emission Reduction / yr	3.7	MMSCF
Gas Price	3	\$/MCF
Benefit \$/Yr	11235	\$/Yr

## References

This technology briefing is based on research conducted for the following study: The EPA Natural Gas STAR Program: Recommended Technologies and Practices – [Taking Compressors Offline](#)

### Exhibit 2: Example Calculation of Potential Gas savings per Year.

Exhibit 2 presents a sample calculation of benefits from the baseline scenario versus maintaining pressure on the compressor during standby.

### Economic Analysis

Keeping compressors fully pressurized when offline achieves immediate payback—there are no capital costs, and emissions are avoided by reducing the net leakage rate.

Specific costs for this alternative include the offline leak rate associated with this option and probable programming costs, which are estimated to be on average \$15,000 including field testing.

The simple payback for maintaining pressure on standby compressors is the net emissions savings, which is the difference between methane emissions from offline leakage for a depressurized compressor and offline leakage of a compressor kept fully pressurized (calculated in Exhibit 2). This is equal to 3.7 MMcf per year on a unit running half of the time.

# Compressor Blowdown Recovery as Fuel Gas

[Return](#)

## Technology Overview

Compressors are used throughout the offshore production industry to recover flash gas (natural gas) from production wells and to export it through pipelines. However, compressors must periodically be taken offline for maintenance, operational standby, or emergency shutdown testing; and as a result, methane may be released to the atmosphere. When compressor units are shut down, the high-pressure gas remaining within the compressors and associated piping between isolation valves is typically released (in a “blowdown”) to a flare or to the atmospheric vent.

The gas volume released during a compressor blowdown depends on several factors, including the size of the compressor, the pipeline pressure, and the pipe volume contained between unit isolation valves. On average, a single blowdown will release approximately 15 thousand standard cubic feet (Mcf) of gas to the flare or to atmosphere.

Changes in operating practices and in the design of blowdown systems can save money and significantly reduce methane emissions. Routing blowdown gas to the fuel gas system or to a lower-pressure gas line reduces fuel costs and avoids blowdown emissions.

## Operation and Implementation

Compressors designated as “base load” operate most of the time and might be taken offline only a few times per year. However, process upsets can cause the unit to trip (shut down automatically) much more frequently.

Each shutdown requires a blowdown of the compressor before the unit can be restarted. This blowdown is frequently performed as part of the stop sequence of the compressor.

Many higher-pressure compressors are configured to supply an alternate source of fuel gas to the fuel gas scrubber. This way, the piping is already in place to enable blowing the unit down partially to the fuel gas system prior to completely blowing it down to atmospheric conditions. However, this process change would likely require programming changes.

The costs of these changes include the capital investment and any incremental operations and maintenance (O&M) costs. The average programming costs are estimated to be \$15,000, including field testing.

If modification requires adding piping and valves to bleed gas from an idle compressor into the fuel gas system or to another low pressure system, facility modification costs range between \$30,000 to \$200,000 per compressor.

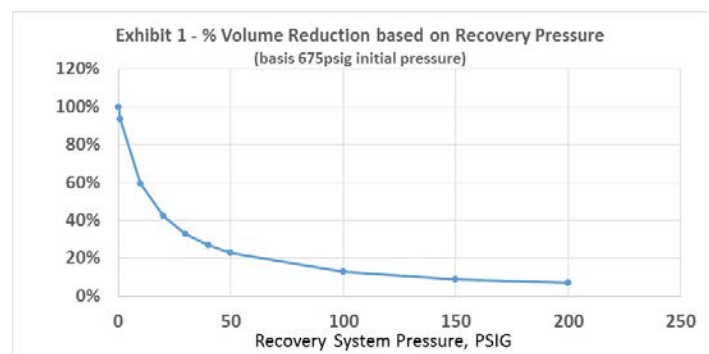

**Exhibit 1: Percent Volume Reduction Based on Recovery Pressure.**

Major determinants of cost are the size of the compressor; the number of fittings, valves, and piping supports; size of piping; length of piping; and automation equipment.

### Applicability

Depressurizing offline compressors to the fuel gas system (or a lower pressure system) is effective only where there is sufficient fuel demand (or low pressure compression capacity) to handle the gas at the blowdown rate. After the pressure in the compressor equilibrates with the fuel line pressure, the compressor can be blown down the rest of the way via the flare or atmospheric vent.

### Emission Reduction Potential

Emissions are avoided by diverting gas to the fuel gas system, where the gas can be utilized rather than emptied to the environment.

### Economic Analysis

Diverting gas to a lower-pressure system requires operators to determine which lower-pressure systems should remain active (and have sufficient capacity to receive the blowdown gas volume) when a higher-pressure compressor shuts down. Examples include lower-pressure vapor recovery; field gas compressors with suction pressure less than the settle-out pressure of the higher-pressure compressor; and a route to either the fuel gas system or the export gas pipeline. Note that the benefit is increased further as the recovery system pressure is lowered (see Exhibit 1).

Exhibit 2 provides the sample volume calculations, which can be utilized to calculate the quantity and value of natural gas that can be recovered by routing the gas to a lower-pressure system.

Applicable Application(s)	
<input checked="" type="checkbox"/>	New Construction
<input checked="" type="checkbox"/>	Retrofit
Applicable Modification(s)	
<input checked="" type="checkbox"/>	Hardware/Equipment
<input type="checkbox"/>	Process
Applicable Structure(s)	
<input type="checkbox"/>	Well-Only Platforms
<input checked="" type="checkbox"/>	Fixed Platforms
<input checked="" type="checkbox"/>	Floating Platforms (SPAR/TLP/CT/Semi-Sub)
Applicable Equipment Type(s)	
<input checked="" type="checkbox"/>	Flare
<input checked="" type="checkbox"/>	Cold Vent

Physical Volume of Compressor and Associated Vessels and Piping	320 CF
Operating Suction Pressure	150 PSIG
Operating Discharge Pressure	1200 PSIG
Settle-Out Pressure on Shutdown	675 PSIG
P2 if All Gas Is Flared	1 PSIG
SCF of Gas for Total Blowdown	14058 SCF
P2 if Some Gas Is Routed to Fuel (or LP System)	150 PSIG
Gas Recovered if Part of Blowdown Routed to Fuel at 200 PSIG	1340 SCF
# of Blowdowns per Month	2 Blowdowns
# of Blowdowns per Year	24 Blowdowns
Total Gas Recovered per Year	32 MSCF

## References

This technology briefing is based on research conducted for the following study: The EPA Natural Gas STAR Program: Recommended Technologies and Practices – [Taking Compressors Offline](#)

**Exhibit 2: Example Calculation of Potential Gas Savings per Year.**

## INSTALLING STATIC SEALS ON COMPRESSOR RODS

[RETURN](#)

### Technology Overview

In the offshore production industry, compressors recover flash gas (natural gas) from production wells and export it to pipelines. Normal practice is to depressurize (blow down) the compressor when it is shut down. However, when redundant compressors are installed and are available to run, one compressor may remain in a pressurized, standby mode. As a result, natural gas may be released to the atmosphere through rod packing seals. These fugitive emissions are not normally measured.

Static seals installed on compression rods can eliminate the gas leaking back through the rod packing while a compressor is shut down under pressure.

A static seal can be installed on each rod shaft outside the conventional packing. An automatic controller activates when the compressor is shut down to wedge a gas-tight seal around the shaft; the controller deactivates the seal on start-up.

### Operation and Implementation

Operators generally conduct compressor maintenance every 12 to 36 months, replacing compressor valves, replacing packing, and performing other preventive maintenance. This outage presents an opportunity for installation of static seals.

Safety is a priority when designing and operating offshore production facilities.

Uptime	45%
Downtime for Maintenance	10%
Standby Time	45%
S/B Hours/Year	3942 Hours
Reduced Leakage with Static Seals	0.3 MCFH
Emission Reduction/Hour	0.3 MCFH
Emission Reduction/Year	1183 MCF
	1.2MMSCF
Gas Price	\$3/MCF
Benefit	\$3548/Year

**Exhibit 1: Example Calculation of Potential Gas savings per Year.**

Maintaining gas pressure on idle compressors and valves causes increased leakage through the compression equipment. Appropriate precautions must be taken within the facility for gas detection, the potential energy hazards of high-pressure vessels, and adequate ventilation to prevent accumulation of leaked gases.

Static seals cost about \$825 per rod, plus \$1,600 for an automatic activation controller for the entire compressor. This totals \$4,900 per four-rod compressor. With engineering, programming, installation labor, and logistics, offshore installation costs are estimated at \$70,000–\$100,000 per unit.

### Emission Reduction Potential

Seals on compressor piston rods will leak during normal operations, but this leakage increases approximately 50% (to about 75 scfh per rod, or 0.3 Mcf/ hour, per four-cylinder compressor) when a compressor is idle with a fully pressurized suction line.

Leaks occur through gaps between the seal rings and their support cups, which are closed (during operation) by the dynamic movement of the piston rod and lubricating oil. If leakage from the compressor rod packing is virtually eliminated, the only remaining potential leakage will be from the blow-down valves to the flare.

Based on 10% downtime and 45% standby time, the annual gas recovery is estimated at 1.2 MMSCF (see Exhibit 1).

### Applicability

The use of static rod packing seals is only beneficial on reciprocating compressors that will be left pressurized for long periods of time (i.e., where there is a standby compressor).

### Economic Analysis

Evaluate simple payback—an industry standard economic analysis method in which first-year costs are compared against the annual value of gas saved.

### References

This technology briefing is based on research conducted for the following study: The EPA Natural Gas STAR Program: Recommended Technologies and Practices – [Taking Compressors Offline](#)

### Applicable Application(s)

- New Construction
- Retrofit

### Applicable Modification(s)

- Hardware/Equipment
- Process

### Applicable Structure(s)

- Well-Only Platforms
- Fixed Platforms
- Floating Platforms (SPAR/TLP/CT/Semi-Sub)

### Applicable Equipment Type(s)

- Flare
- Cold Vent

## INSTALLING EJECTORS ON COMPRESSOR BLOW-DOWN VENT LINES

[RETURN](#)

### Technology Overview

Compressors are used throughout the offshore production industry to recover flash gas (natural gas) from production wells and export it through pipelines. Periodically, compressors must be taken offline for maintenance, operational standby, or emergency shut-down testing, and as a result, methane may be released to the atmosphere. When compressor units are shut down, the high-pressure gas remaining within the compressors and associated piping between isolation valves is “blown down” to the flare or to the atmosphere. In addition to blow-down emissions, a depressurized system may continue to leak gas from faulty or improperly sealed unit isolation valves, which are estimated to leak at an average rate of 1.4 thousand standard cubic feet (Mcf) per hour.

Changes in operating practices and in the design of blow-down systems can save money and reduce methane emissions by keeping systems fully or partially pressurized during an extended compressor shutdown. Though pressurized systems may also leak from a closed blow-down valve and from reciprocating compressor rod packings (or centrifugal compressor seals), total emissions can be significantly reduced. One method of reducing emissions is using an ejector. An ejector uses the discharge of an adjacent compressor as motive to pump blow-down or leaked gas from a shut-down compressor into the suction of an operating compressor or a fuel gas system. Benefits of this practice include fewer bulk gas releases, lower leak rates, and lower fuel costs, with payback manifesting in less than a year in many cases.

The largest source of methane emissions associated with taking compressors offline comes from depressurizing the system by venting the gas that

remains within the compressor and the piping associated with the compressor. The gas volume released during a compressor blow down depends on several factors, including the size of the compressor, the pipeline pressure, and the pipe volume contained between unit isolation valves. On average, a single blow down will release approximately 15 thousand standard cubic feet (Mcf) of gas to the atmosphere.

Methane emissions from compressors taken offline can be significantly reduced by installing ejectors on compressor blow-down vent lines. An ejector is a venturi nozzle that uses high-pressure gas as motive fluid to draw suction on a lower-pressure gas source, discharging into an intermediate-pressure gas stream. The ejector can be installed on vent connections up and down stream of a partly closed valve or between the discharge and suction of a compressor. This creates the necessary pressure differential. The captured gas and the motive gas are then routed to the compressor suction or fuel gas system.

### Operation and Implementation

Recovering gas via an ejector is effective only where there is sufficient capacity in the recovery system to consume the gas at the rate of the blow down.

Although the maintenance and repair costs of gas-handling equipment can be prohibitive in terms of valve materials and labor, when combined with better operating routines, better facility and



equipment design, and the elimination of unnecessary blow-down practices, significant cash flow can be added to the bottom line of many operations. Many of these operations have economic incentives to reduce lost and unaccounted-for gas.

### Emission Reduction Potential

Installing ejectors will recover blow-down gas that would otherwise be vented and allow the operator to direct it to a useful outlet.

The total methane emissions from offline, depressurized compressors is the sum of the losses from venting the compressor and associated piping and the losses across the unit valves for the period of time the compressor is depressurized.

Total emissions (TE) are calculated as:

$$TE = B \times V + T \times U.$$

and the total value (TV) or cost of these emissions is:

$$TV = TE \times P.$$

- Where:
- B = Number of blow downs per year
  - V = Pressurized compressor volume between unit isolation valves
  - T = Duration of the shut-down period
  - U = Leakage rate at the unit valves
  - P = Price of gas

### Applicability

The addition of ejectors is only applicable where there is a high-pressure system still available for motive gas, an export path available, and an IP or LP compressor. These conditions may be applicable for a very limited number of cases.

The feasibility and cost of installing ejectors, either singly or in combination with other methods, must be considered by operators when modifications to compressor shut-down procedures are developed.

### Economic Analysis

The capital and installation costs of a typical venturi ejector system are estimated to be \$100,000. In addition to the ejector itself, capital expenditures include ejector block valves, piping from the blow-down vent line connections, and engineering design work to size the nozzle and expander for the site.

### References

This technology briefing is based on research conducted for the following study: The EPA Natural Gas STAR Program: Recommended Technologies and Practices – [Taking Compressors Offline](#)

### Applicable Application(s)

- New Construction
- Retrofit

### Applicable Modification(s)

- Hardware/Equipment
- Process

### Applicable Structure(s)

- Well-Only Platforms
- Fixed Platforms
- Floating Platforms (SPAR/TLP/CT/Semi-Sub)

### Applicable Equipment Type(s)

- Flare
- Cold Vent

## RECOVER GAS FROM PIPELINE PIGGING OPERATIONS

[RETURN](#)

### Technology Overview

Gases rich in recoverable hydrocarbons tend to condense liquids in offshore gas export pipelines. These systems are frequently pigged with spherical, disc (see Exhibit 1), or bullet-shaped pigs to remove accumulated liquids and reduce the pipeline pressure drop. This improves gas flow and pipeline efficiency.



**Exhibit 1: Example Pig Used in the Trans-Alaska Pipeline<sup>1</sup>**

The gas flow in the pipeline transports the pig; however, inserting and removing the pig (to/from a launcher or receiver) is a manual exercise. Opening the trap requires depressurizing the pig trap from normal export pressure to atmospheric pressure, usually to the flare.

The majority of intermittently flared gas could be recovered and sold if it were depressurized to a low-pressure compressor prior to the final depressurizing to atmospheric conditions.

### Operation and Implementation

The required equipment to be installed includes small-bore (~3/4 or 1") piping, isolation valves, pressure indicators, and a break-out spool. It is assumed that a pig launcher and/or receiver is already present on site and a vapor recovery compressor with adequate capacity is available.

Procedures and training would be required to prevent accidental misdirected flow from the export gas system back to the VRU suction.

### Applicability

Gas recovery is possible at any gas pigging station that is currently being depressurized to the flare or a vent.

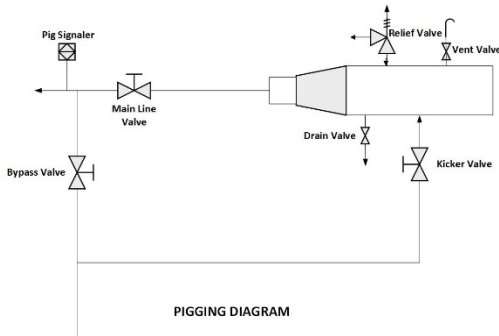

**Exhibit 2: Example Pigging Diagram.**  
 Source: Argonne Vent/Flare Research Team

Offshore pig traps could be depressurized to low-pressure (LP) systems before the flare or vent, which could cause significant reduction in cases where gas line pigs are used frequently (i.e., weekly).

Although most offshore production facilities have a gas export system and pig launcher, pigging frequency is variable based on gas composition, flowing velocity, pressure, and pipeline terrain. It is estimated that 30 % of structures with gas pig launchers send pigs regularly (avg 1/wk).

### Emission Reduction Potential

The methane emission savings are based on a typical-sized pig trap of 16” diameter and 8 ft length (see Exhibit 3) being depressurized from 1000 psig to 100 psig prior to venting/flaring the remaining pressure to atmospheric conditions.

### Economic Analysis

This emission reduction opportunity is independent of the production rate for the structure or facility, except that pigging is only done while the production is at or near normal rates. The gas that would be recovered by the system would be sold almost immediately.

The cost of the system is an estimate of engineering, materials, and construction costs. It is further assumed that the costs would be ~ 50% less on a new facility, since they would be integrated into the larger project.

### References

1. Harvey Barrison. Trans-Alaskan Pipeline – 26.  
<https://www.flickr.com/photos/harrison/991988019/in/album-72157601184642247/> (accessed 22 Aug 2016)  
<https://creativecommons.org/licenses/by-sa/2.0/legalcode>.

This technology briefing is based on research conducted for the following study. The EPA Natural Gas STAR Program: Recommended Technologies and Practices – [Recover Gas from Pipeline Pigging Operations](#)

Applicable Application(s)	
<input checked="" type="checkbox"/>	New Construction
<input checked="" type="checkbox"/>	Retrofit
Applicable Modification(s)	
<input checked="" type="checkbox"/>	Hardware/Equipment
<input checked="" type="checkbox"/>	Process
Applicable Structure(s)	
<input type="checkbox"/>	Well-Only Platforms
<input checked="" type="checkbox"/>	Fixed Platforms
<input checked="" type="checkbox"/>	Floating Platforms (SPAR/TLP/CT/Semi-Sub)
Applicable Equipment Type(s)	
<input checked="" type="checkbox"/>	Flare
<input checked="" type="checkbox"/>	Cold Vent

## CAPTURE GAS WHEN DEPRESSURIZING A PIPELINE

[RETURN](#)

### Technology Overview

Operators of natural gas pipeline systems routinely reduce line pressure and discharge gas from pipeline sections to ensure safe working conditions during maintenance and repair activities. The gas is typically discharged to a flare, but in some cases, it may be vented.

Sometimes, in-field flow lines need to be depressurized. In those cases, the system pressure that the flow line is connected to is the lowest pressure that can be achieved before venting or flaring the remaining pressure.

If the work can be planned in advance, it may be possible to capture most of the gas rather than flare it. Where piping and available compression exist downstream, the gas can be rerouted and sold. In the case of flow lines upstream of the production platform, it may be possible to route the flow line to a test separator and depressurize it in stages to the intermediate and low-pressure systems prior to venting or flaring the rest.

### Operation and Implementation

Temporary compression is often impractical because of the high horsepower requirements for any significant gas rate to be captured. The driver of such a portable compressor would need to be diesel driven, unless fuel gas or electric supply was built into the original facility design. Diesel-driven units may be available, but for the multistage package that would be required in this application, the footprint for the equipment would likely be too large for most platforms to accommodate.

Rental costs, connection costs, and operating costs would need to be estimated for each specific situation.

### Applicability

Pipeline pump-down techniques are only applicable for planned maintenance activities and cases where piping exists to a permanent downstream compressor. Alternatively, sufficient manifolding and connections can enable the use of a portable compressor.

If the segment of piping can be depressurized from an onshore location, then the practicality of a portable compressor is increased by the higher likelihood of electric power or fuel gas.

### Emission Reduction Potential

The emission reduction potential is greater for larger-volume (larger diameter or longer distance), higher-pressure gas lines. In those cases, the gas can be sold rather than flared or vented.

For example, consider a 10 mile 30” diameter pipeline with a pressure of 1000 psig. If two-thirds of the gas in that segment could be recovered, it would capture approximately 16,000 MCF.

### Economic Analysis

If the revenue of the captured gas is greater than the cost of the recovery efforts, the economics and environmental benefits support the effort.

### References

This technology briefing is based on research conducted for the following study: The EPA Natural Gas STAR Program: Recommended Technologies and Practices – [Pipeline Pump-Down Techniques](#)

### Applicable Application(s)

- New Construction
- Retrofit

### Applicable Modification(s)

- Hardware/Equipment
- Process

### Applicable Structure(s)

- Well-Only Platforms
- Fixed Platforms
- Floating Platforms (SPAR/TLP/CT/Semi-Sub)

### Applicable Equipment Type(s)

- Flare
- Cold Vent

## PIPELINE PURGING WITH NITROGEN

[RETURN](#)

### Technology Overview

When pipeline segments are taken out of service for maintenance or repairs, it is common practice to depressurize the pipeline and vent the natural gas to the atmosphere. To prevent these emissions, a pig is inserted into the isolated section of the pipeline, and inert gas (nitrogen) is then pumped in behind the pig. The nitrogen pushes natural gas through to the product line. At the appropriate shutoff point, the pig is caught in a pig trap and the pipeline blocked off. Once the pipeline is “gas free,” the inert gas is vented to the atmosphere. To assist with separation between the nitrogen and the natural gas, sometimes a slug of glycol is used in addition to the pig.

### Operation and Implementation

This application requires existing pig-launch and pig-trap facilities and a significant nitrogen supply. Rental nitrogen generators and compressors to boost the

pressure significantly are available. They require a large space on the platform and heavy lifts with the crane.

### Applicability

Nitrogen pigging techniques are only applicable for planned maintenance activities and cases where pigging facilities are available on both ends of the pipeline segment. In addition, a large nitrogen generator package must be accommodated on the upstream platform. Larger pipelines will require more nitrogen volume. Generating large volumes of high-pressure nitrogen could take days, which may make this alternative infeasible.

Facilities with built-in, permanent nitrogen generation (if sufficiently sized) could consider this alternative without the expense of rental equipment.

---

## Emission Reduction Potential

The emission reduction potential is greater for larger-volume (larger diameter or longer distance), higher-pressure gas lines. In those cases, the gas can be sold rather than flared or vented.

For an example, consider a 10 mile 30” diameter pipeline at 1000 psig. If two-thirds of the gas in that segment could be recovered, it would capture approximately 16,000 MCF.

---

## Economic Analysis

If the revenue of the captured gas is greater than the cost of the recovery efforts, the economics and environmental benefits support the effort.

---

## References

This technology briefing is based on research conducted for the following study: The EPA Natural Gas STAR Program: Recommended Technologies and Practices – [Inert Gas to Purge Pipelines](#)

---

### Applicable Application(s)

- New Construction
- Retrofit

---

### Applicable Modification(s)

- Hardware/Equipment
- Process

---

### Applicable Structure(s)

- Well-Only Platforms
- Fixed Platforms
- Floating Platforms (SPAR/TLP/CT/Semi-Sub)

---

### Applicable Equipment Type(s)

- Flare
  - Cold Vent
-

## REDUCED EMISSIONS COMPLETIONS

[RETURN](#)

### Technology Overview

In recent years, the onshore production industry has developed more technologically challenging, unconventional gas reserves through the use of horizontal drilling and multistage hydraulic fracturing. While unconventional resource development is not yet as common offshore (because of the significantly higher cost), hydraulic fracturing offshore has been used since the early 1990s (e.g., frac-packs), primarily to maximize the financial return on investments in existing fields and wells through enhanced recovery of conventional resources.

Advances in stimulation technologies have made it possible to exploit challenging, unconventional gas reservoirs, including those in low-permeability (tight) formations found in partially depleted existing wells (workovers and recompletions) and those that are targets of new exploration and development drilling. In both cases (completions of new wells in tight formations and workovers/recompletions of existing wells), one technique for improving gas production is to fracture the reservoir rock with very high-pressure water containing a proppant (generally sand) that keeps the fractures “propped open” after water pressure is reduced. In a vertical well, the process is usually limited to one stage, but in a well with a long horizontal section, there can be as many as 30 or 40 stages.

Immediately following the frac job in both new and existing wells, fluids are produced at a high rate to lift any excess sand to the surface and clear the perforations, well bore, and formation face. This improves the flow of oil, gas, and formation water. Typically, the gas/liquid separator installed for normal well flow is not designed to handle the

possible high volume of abrasive solids that can include both proppant and formation sand or the emulsions that could result from completion fluids and reservoir fluids mixing. Therefore, a common practice on an offshore platform is to flare the gas into temporary storage facilities where water, hydrocarbon liquids, and sand are captured, and gas is vented to the atmosphere or flared. Completions can take anywhere from one day to several weeks, during which time a substantial amount of gas may be released to the atmosphere or flared.

Reduced emissions completion (RECs)—also known as *reduced flaring completion* or *green completion*—is a term used to describe an alternate practice, mostly used onshore, that captures gas produced during well-completions and well workovers following hydraulic fracturing. Portable equipment is brought onsite to separate the gas from the solids and liquids produced during the high-rate flowback and to produce gas that can be delivered into the sales pipeline if one can be easily accessed. Applying this practice offshore is limited by the space available on the platform for the additional equipment compared to the space required for, and the rental cost (including transportation) of, temporary equipment. RECs help reduce methane, VOC, and HAP emissions during well cleanup and can eliminate or significantly reduce the need for flaring.

### Operation and Implementation

If there is room for equipment on the platform, it is possible in the offshore environment to mimic the current trend onshore and use RECs to recover much of the gas that is normally vented or flared during the completion flowback process. This involves installing portable equipment that is specially designed and sized for the initial high rate of water,



sand, and gas flowback during well completion. The objectives are to keep the fluids out of the normal production train and to capture and deliver gas to the sales line rather than venting or flaring this gas. Offshore, it is necessary to dehydrate (remove water from) the produced gas before it enters the sales pipeline, so the gas would need to be routed to the permanent glycol unit for dehydration.

Liquids are separated from the gas and processed or captured for onshore processing. As much water as possible is removed, treated, and discharged overboard. Temporary piping is usually used to connect the well to the REC skid.

The equipment used during RECs is only necessary for the time it takes to flow back the fluids from the frac job and/or completion fluids; therefore, the equipment should be easily removable to free up the limited and valuable space on the platform. Most producers prefer leased equipment with dedicated operators for well flowback equipment. If the intention is to complete a number of wells on the same platform over a long period of time (possibly years), permanent equipment may be installed on the platform with appropriate piping and valve headers. This would allow the capital investment to be spread over a number of wells.

If a third-party contractor is used to perform an REC, the cost used to assess the economic viability of an REC program should only include the incremental costs to carry out RECs versus traditional completions. This incremental cost can vary widely depending on the platform configuration, location (water depth and seafloor stability), and crane capacity. The available space or crane capacity may require many separate small skids or may allow fewer, larger skids. The location may allow the use of a lift boat on which to keep the REC equipment or

may require all of the equipment to be placed on the platform.

Generally, the third-party contractor will charge a commissioning fee for transporting and setting up the equipment for each well completion or group of completions on the platform.

There are rental equipment costs, installation costs, and labor costs to operate each REC. As mentioned above, when evaluating the costs of well completions, it is important to consider the incremental cost of an REC over a traditional completion, rather than focusing on the total cost. Equipment costs associated with RECs will vary from platform to platform and from well to well and would typically be at least \$20,000 for a temporary installation

High production rates may require larger equipment to perform the REC and will increase costs.

If permanent equipment, such as a glycol dehydrator, is already installed, REC costs may be reduced, as this equipment can be used rather than bringing a portable dehydrator onsite (assuming the flowback rate does not exceed the capacity of the equipment). Some operators report installing permanent equipment that can be used in the RECs as part of normal well completion operations and regular well testing operations (such as oversized three-phase separators), further reducing incremental REC costs. Well completion flowbacks usually take 2 to 10 days to clean out the well bore, complete well testing, and tie into the permanent production facilities. BSEE limits flaring for well flowbacks to 48 hours unless special permission is granted.

## Applicability

Wells that require hydraulic fracturing to stimulate or enhance gas production may need a lengthy flowback period, and therefore are good candidates for RECs. Long flowback times mean that a significant amount of gas may be vented or flared and could potentially be recovered and sold for additional revenue to justify the additional cost of a REC.

The production platform would need to have adequate space and weight available for the temporary equipment and tie-in points for the gas to be returned to the processing system.

## Emission Reduction Potential

Natural gas lost during well completion and testing can range from 1–50 million cubic feet (MMcf) per well depending on well production rates and the number of test days.

RECs allow for recovery of gas rather than venting or flaring, and therefore reduce the environmental impact of well completion and workover activities.

## Economic Analysis

Once the quantity and value of natural gas recovered and reduced emissions are determined and the cost is established, an economic analysis of the emission mitigation can be performed

Gas recovered from RECs can vary widely because the amount of gas recovered depends on a number of variables, such as reservoir pressure, production rate, and total flow time to the gas recovery system. Not all the gas that is produced during initial well flowback may be captured for sales, since it may be necessary to flow against very low back pressure initially due to hydrate risks. Gas saved during RECs can be translated directly into emissions reductions.

Simple payback is an industry standard economic analysis method in which the first-year costs are compared against the annual value of gas saved.

## References

This technology briefing is based on research conducted for the following study: The EPA Natural Gas STAR Program: Recommended Technologies and Practices – [Reduced Emission Completions for Hydraulically Fractured Natural Gas Wells](#)

### Applicable Application(s)

- New Construction
- Retrofit

### Applicable Modification(s)

- Hardware/Equipment
- Process

### Applicable Structure(s)

- Well-Only Platforms
- Fixed Platforms
- Floating Platforms (SPAR/TLP/CT/Semi-Sub)

### Applicable Equipment Type(s)

- Flare
- Cold Vent

## WELL UNLOADING - FOAMING AGENTS

[RETURN](#)

### Technology Overview

In gas wells, liquids accumulate in the tubing, creating additional back pressure against the producing formation. This slows gas velocity and eventually stops gas flow (loading up). A common approach to temporarily restore flow, when gas compression to lower the surface flowing pressure is not available, is to flow the well to atmospheric pressure (flare or vent to “unload” the liquids), which produces substantial emissions. Foaming agents or surfactants (also called “soap”) can help lift accumulated liquids and temporarily restore production from the well without venting or flaring.

Foam reduces the density and surface tension of the liquid column, which also reduces the critical gas velocity needed to lift liquids to the surface and aids liquid removal from the well (see Exhibit 1). Compared to other artificial lift methods, foaming agents are one of the least costly applications in terms of capital investment for unloading gas wells.

### Operation and Implementation

Surfactants are delivered to the well as soap sticks or as a liquid injected directly into the casing-tubing annulus or down a capillary tubing string. For shallow

wells, surfactant delivery can be as simple as the operator periodically pouring surfactant down the annulus of the well through an open valve. For deep wells (more typical offshore), a surfactant injection system requires the installation of surface equipment, as well as regular monitoring.

The easiest method of introducing soap sticks into the well bore is with a hatch arrangement (or ‘lubricator’) comprised of two full-opening ball valves separated by an 18–24 inch length of pipe all mounted above the cap on top of the tree. Alternatively, an automatic soap stick launcher can be installed at significantly more capital expense, but less operating expense, than using a manual hatch.

For liquid surfactant, a reservoir, an injection pump, a motor valve with a timer (depending on the installation design), and a power source for the pump may be used. No equipment is required in the well, although foaming agents and velocity tubing may be more effective when used in combination.

The amount of water typically removed by one soap stick ranges from 1–5 bpd, and the total amount of liquid removable by this method peaks at about 50–100 bpd.

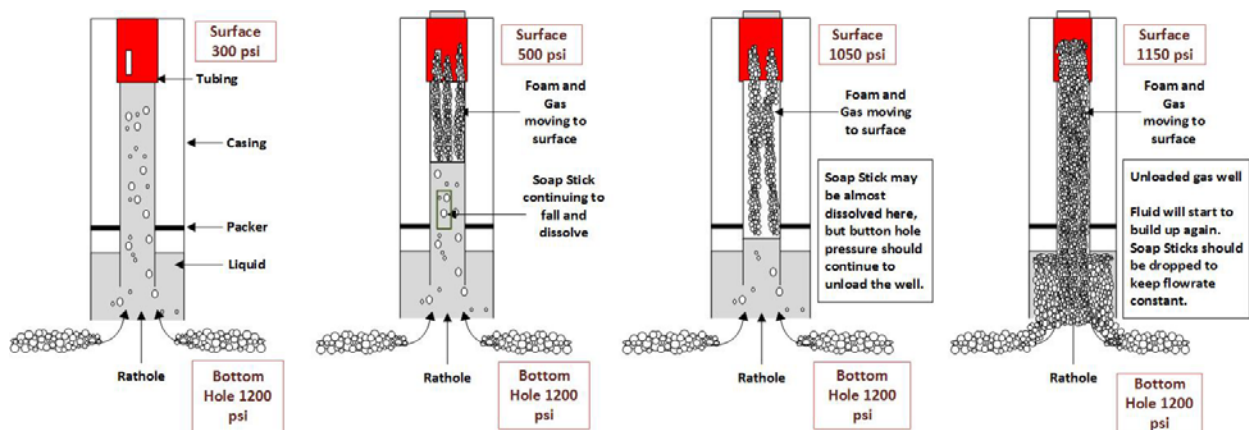

Exhibit 1: Soap Stick Illustration in Well Bore.1

Concerning low flow rate wells, solid surfactants will lower by 5% to 20% the Turner-Coleman (see Exhibit 2) rates (critical flow rates for the removal of liquids from the well bore) necessary to produce the well after other variables are met. A weaker well or a loaded well can be shut in for an extended period to increase the flow rate for unloading liquid from the tubing after the stick has been dropped.

In high-rate producers, the maximum flow rate at which a soap stick will fall is approximately 400 Mcfd in 2-3/8" tubing and approximately 600 Mcfd in 2-7/8" tubing. When a well flows above these rates, the well should be shut in for 5 to 10 minutes to allow the stick to fall into the water column.

If venting a well is the current fluid removal approach, the application of foaming agents should be evaluated before well blow downs become too frequent, less effective, and costly.

Costs associated with fluid removal options include capital, start-up, and labor expenditures to purchase and install the equipment, as well as ongoing costs to operate and maintain the systems. For foaming agents, the upfront capital and start-up costs to install soap launchers range from \$10,000 to \$20,000 per well, plus the cost of labor. Soap sticks cost between \$5 and \$10 each if purchased in bulk and depending on the formulation. Further, if a manual hatch type launcher is used, the cost of labor to monitor and launch the stick must be included in the operating cost. Assuming an inexpensive formulation (\$5/stick), the monthly cost of the surfactant would be \$150/month/daily stick used. Again, labor must be added to this if manual launching is used.

If a chemical pump system is required, the cost would be \$30,000–\$50,000 per system (1–10 wells).

## Applicability

Foaming agents are only applicable on direct vertical access (DVA) gas wells that do not commingle fluids with other wells, since the foaming can create processing difficulties (emulsion) topside where oil and water separation occurs.

There is not a finite depth limitation with the use of soap sticks other than maximum temperature. This fact makes solid surfactants an attractive option for deeper completions.

Soap sticks are immune to increases in pressure and may be used in high-pressure applications. Soap sticks are available for both low- and high-temperature use. Using surfactants at extreme temperatures, however, can cause the chemical components to degrade.

The variables involved in the decision to employ soap sticks are produced water volume and water column temperature gradient. The solid surfactant in a soap stick, used correctly, does not need to migrate deeply into the water column, so bottom-hole temperature may not be the controlling factor.

Foamer formulations are specific for the presence of fresh water or water with high chloride count. Foaming agents work best if the fluid in the well is at least 50% water. Surfactants are not effective for natural gas liquids or liquid hydrocarbons, with the exception of some recent formulations developed specifically to address high 'oil' fractions in the liquid stream. Typically, the oil cut can be as high as 50% for the extended, continuous use of surfactants. They are most effective when the maximum amount of oil or condensate is 30% when using surfactants on a daily basis, such as with an automated launcher. These upper limits do not apply for the occasional use of surfactants.

Operators typically use foaming agents early in the life of gas wells when the wells begin to load with formation water, but the liquid production rate is comparatively low. They are also commonly used to allow a high water content flowing well to continue producing until an artificial lift (i.e., gas lift or plunger lift) can be installed or at the end of a well’s economic life when artificial lift is not warranted.

Foaming agents may also be used in combination with other well treatments that reduce salt and scale build up, or may be applied in combination with small-diameter tubing (also known as a *velocity string*).

site; and the capabilities and training of field personnel.

The installation of smaller-diameter tubing may extend the life cycle of a high water cut gas well before artificial lift is required. The curves in Exhibit 2 provide an estimate of the critical rate necessary to keep water from gathering at the bottom of a well versus surface flowing pressure, depending on pipe diameter.

It has been reported that the use of soap sticks can reduce the critical rate to unload the well by 5% to as much as 20%.

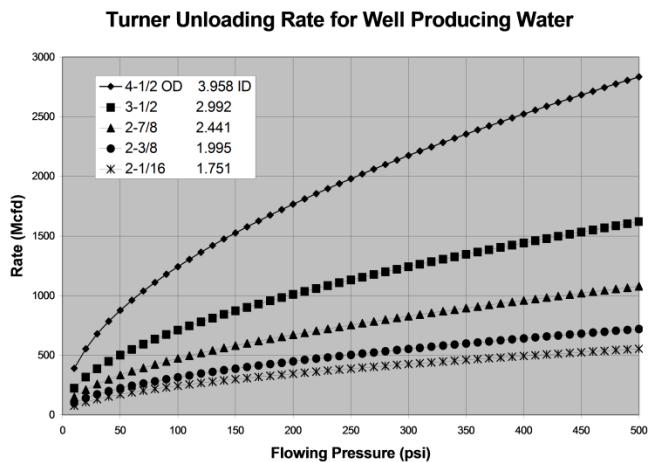

Exhibit 2: Schematic of the Turner Unloading Rate for Wells Producing Water.<sup>2</sup>

Various data and criteria should be evaluated to select a fluid removal approach that is both technically feasible and cost effective. This data includes IPR (inflow performance relationship) curves; reservoir pressure; gas and fluid (hydrocarbon and water) production flow rates; fluid levels in the well; the desired flowing bottom-hole pressure and casing pressure; production tubing size; the downhole condition of the well; other mechanical limitations of the well and production

### Emission Reduction Potential

The most significant benefit of deploying foaming agents is to extend the productive life of the well by decreasing the abandonment pressure of the reservoir and increasing the cumulative gas production.

There is also the time value of money realized by delaying the purchase and installation of artificial lift equipment.

The more common evaluation is for a well already experiencing production decline. In such a case, estimating incremental gas production from installing velocity tubing is more complex and requires generating a new “expected” production and decline curve that would result from reducing the back pressure at the well perforations. This requires well-specific reservoir engineering analyses.

Because foaming agents have a limited application, it is estimated that only 10–15% of late-life well unloading flare/vent can be reduced. In the Natural Gas Energy Star Lessons learned, emissions savings have been reported that range from 500 thousand cubic feet (Mcf) per well to more than 27,000 Mcf/well.

The benefits of increased gas production will vary considerably among individual wells and reservoirs, but can be substantial.

## Economic Analysis

The decision to implement any type of liquid removal option during the life cycle of a gas well should be made when the value of the estimated incremental gas production exceeds the cost of the fluid removal option. Basic cash flow analysis can be used to compare the costs and benefits of using foaming agents.

## References

1. AltaChem Ltd. Solid Chemical Stick Applications for OPTIMIZATION of Gas Production, with permission [altachem@shaw.ca](mailto:altachem@shaw.ca).
2. The Artificial Lift R&D Council. Guidelines and Recommended Practices – Selection of Artificial Lift Systems for Deliquifying Gas Wells. <http://beta.alrdc.com/recommendations/gas%20well%20deliquification/artificial%20lift%20selection%20---%20new%20version.htm> (accessed 22 Aug 2016).

This technology briefing is based on research conducted for the following study: The EPA Natural Gas STAR Program: Recommended Technologies and Practices – [Options for Removing Accumulated Fluid and Improving Flow in Gas Wells](#)

### Applicable Application(s)

- New Construction
- Retrofit

### Applicable Modification(s)

- Hardware/Equipment
- Process

### Applicable Structure(s)

- Well-Only Platforms
- Fixed Platforms
- Floating Platforms (SPAR/TLP/CT/Semi-Sub)

### Applicable Equipment Type(s)

- Flare
- Cold Vent



## WELL UNLOADING – VELOCITY TUBING

[RETURN](#)

### Technology Overview

In gas wells, liquids accumulate in the tubing. This creates additional back pressure against the producing formation, slowing gas velocity and eventually stopping gas flow (loading up). A common approach to temporarily restoring flow, when gas compression to lower the surface flowing pressure is not available, is to flow the well to atmospheric pressure (flare or vent to “unload” the liquids), producing substantial emissions. One option to overcome liquid loading is to install smaller-diameter production tubing or “velocity tubing.” For the same gas volume per unit time, the cross-sectional area of the conduit through which gas is produced determines the velocity of flow and can be critical for controlling liquid loading. A velocity string reduces the cross-sectional area of flow and increases the flow velocity, achieving liquid removal without venting or flaring gas. The diameter of the velocity string is selected to lower the velocity required to lift the liquid, without significantly increasing the back pressure against the reservoir that would be caused by increased friction.

Exhibit 1 shows that the conduit for gas flow up a well bore can be either production tubing (usual circumstance), the casing-tubing annulus, or, in rare cases, simultaneous flow through both the tubing and the annulus.

Installation of velocity tubing requires a well workover rig to place the smaller tubing string in the well. Due to high costs and the availability of other options for artificial lift, velocity strings are rarely implemented offshore.

Coiled tubing may also be used, allowing for easier installation and the application of a greater range of

tubing diameters, normally between 1 and 3.25 inches.

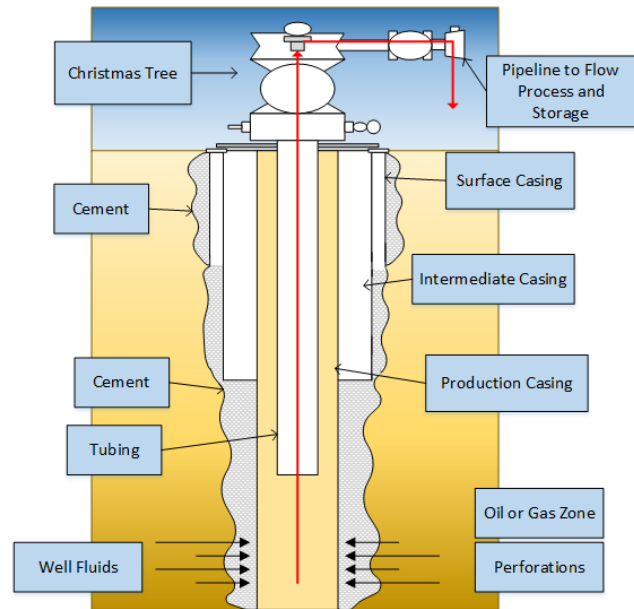

**Exhibit 1: Tubing and/or Annular Flow Is Possible.**

### Operation and Implementation

If venting a well is the current fluid removal approach, the application of velocity tubing should be evaluated before well blow downs become too frequent, less effective, and costly. The sizing of velocity tubing is based on the Turner-Coleman critical flow rate, which, for the case of water, can be estimated from the plot in Exhibit 2. The plot in Exhibit 2 also demonstrates the effect of smaller-diameter tubing on the gas rate necessary to unload liquid from the well. Similar plots can be generated for loading with crude oil or condensate alone or in combination with water.

As a rule of thumb, a gas flow velocity of approximately 1,000 feet per minute is the minimum necessary to remove fresh water. Condensate requires less velocity due to its lower density, while more dense brine requires a higher velocity. Once the velocity string is installed, no other artificial lift

equipment is required until the reservoir pressure declines to the point that velocities of 1,000 feet per minute are no longer possible in the tubing

of 1,000 feet per minute can be used. These figures assume that the used pipe is in good condition with low relative roughness in the pipe wall.

Turner Unloading Rate for Well Producing Water

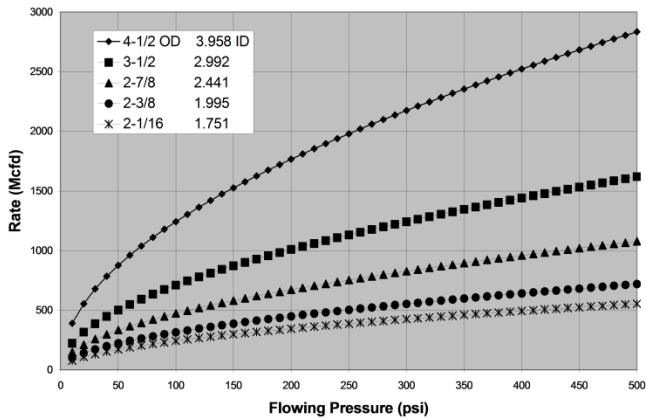

Exhibit 2: Schematic of the Turner Unloading Rate for Wells Producing Water<sup>1</sup>

Coiled tubing can be applied in wells with lower gas production rates due to better relative roughness characteristics and the absence of pipe joint connections. Studies indicate that seamed coiled tubing provides better lift characteristics due to the elimination of turbulence in the flow stream because the seam acts as a “straightening vane.”

Costs associated with installing velocity tubing are primarily offshore rig and equipment costs and material costs.

Based on industry experiences, typical costs will vary widely depending the type of rig needed and the well depth, since a rig is needed to pull the existing tubing, packer, and other materials out of the well.

### Applicability

A 2004 study estimated that gas velocity must be at least 5 to 10 ft/sec (300 to 600 ft/min) to effectively remove hydrocarbon liquids from a well, and at least 10 to 20 ft/ sec (600 to 1200 ft/min) to move produced water. As a rule of thumb, gas flow velocity

Velocity tubing to facilitate liquid removal can be successfully deployed in low-volume gas wells upon initial completion or near the end of their productive lives.

Various data and criteria should be evaluated to determine if velocity tubing is both technically feasible and cost effective. This data includes IPR (inflow performance relationship) curves; reservoir pressure; gas and fluid production flow rates; fluid levels in the well; the desired flowing bottom hole pressure and casing pressure; production tubing size, the downhole condition of the well; other mechanical limitations of the well and production site; and the capabilities and training of field personnel.

The Turner relationship (based on a spherical water droplet theory) and Lee relationship (based on a flat water droplet theory) between critical flow rate (critical gas velocity) and flowing pressure for various sizes of production tubing can help evaluate if velocity tubing should be implemented. If the relationship between flow rate and pressure falls below a line specifying the size of production tubing, a well will not flow liquids to the surface for the indicated tubing size. If flow rate versus pressure falls on or above the line for a specified tubing size, a well meets or exceeds the critical flow rate for the specified tubing size, and the well is able to unload that fluid type to the surface. Exhibit 2 can be used to estimate whether velocity tubing is likely to be effective.

Velocity tubing strings are appropriate for natural gas wells with relatively small liquid production and higher reservoir pressure. Low surface pipeline pressure relative to the reservoir pressure is also



necessary to create the pressure drop that will achieve an adequate flow rate. The depth of the well affects the overall cost of the installation, but is usually offset by the higher pressure and gas volume in deeper wells. Velocity tubing can also be a good option for deviated wells and crooked well bores.

### Emission Reduction Potential

Reclaimed vented or flared gas can be routed instead to sales, generating revenue and reducing emissions. The most significant benefit of deploying velocity tubing is to extend the productive life of the well by decreasing the abandonment pressure of the reservoir and increasing the cumulative gas production.

The more common evaluation is for a well already experiencing production decline. In such a case, estimating incremental gas production from installing velocity tubing is more complex and requires generating a new “expected” production decline curve that would result from reducing the

back pressure at the well perforations. This requires well-specific reservoir engineering analyses.

Emissions from venting gas to the atmosphere vary in both frequency and flow rates and are entirely well and reservoir specific. The volume of natural gas emissions avoided by reducing or eliminating well blow downs will vary due to individual characteristics, such as sales line pressure, well shut-in pressure, fluid accumulation rate, and well dimensions (such as depth and casing and tubing diameters). Another key variable is an operator’s normal practice for venting wells.

Reported annual emissions attributable to well blow downs vary from 1 Mcf per well to several thousand Mcf per well, so methane emissions savings attributable to avoided emissions will also vary according to the characteristics and available data for the particular wells being vented.

## References

1. The Artificial Lift R&D Council. Guidelines and Recommended Practices – Selection of Artificial Lift Systems for Deliquifying Gas Wells. <http://beta.alrdc.com/recommendations/gas%20well%20deliquification/artificial%20lift%20selection%20---%20new%20version.htm> (accessed 22 Aug 2016).

This technology briefing is based on research conducted for the following study: The EPA Natural Gas STAR Program: Recommended Technologies and Practices – [Options for Removing Accumulated Fluid and Improving Flow in Gas Wells](#)

### Applicable Application(s)

- New Construction
- Retrofit

### Applicable Modification(s)

- Hardware/Equipment
- Process

### Applicable Structure(s)

- Well-Only Platforms
- Fixed Platforms
- Floating Platforms (SPAR/TLP/CT/Semi-Sub)

### Applicable Equipment Type(s)

- Flare
- Cold Vent

## INSTALLATION OF A FLARE SYSTEM

[RETURN](#)

### Technology Overview

Remote and unmanned production sites may vent low-pressure natural gas and vapors from storage tanks and other onsite equipment to the atmosphere. These emissions can be reduced by installing flares to combust these gases instead of venting them to the atmosphere.

Flare systems typically consist of a long, cantilevered or vertical flare boom with one or two pilots, a flare scrubber vessel, and a network of piping and connections from processing equipment. Emissions sources, such as tank vents, compressor blow-down lines, low-pressure separator vents, overpressure relief valves, and other vent streams, are piped directly to the flare.

Flares are commonly installed on higher-pressure blow-down or emergency pressure relief valves for safety reasons. Low-pressure gas installations have been justified by environmental emissions control.

### Operation and Implementation

If the heat content of the stream is below 300 Btu per scf, auxiliary fuel is needed. The average pilot gas consumption is 70 scf per hour per pilot burner.

A flare system will require a flare scrubber vessel to remove liquids. The scrubber's size will depend on the potential rate from equipment tied into the flare system. Often, when all of the processing equipment is tied into the flare, the flare scrubber is the largest vessel on the platform. If it was not part of the original design, a full functioning flare system to handle all of the processing equipment would likely be infeasible. Smaller combustion flares may be viable for very low-pressure, low-rate vent streams.

Consistent with an OOC presentation on venting and flaring in the Gulf of Mexico, offshore structures without current flare booms are categorized as:

1. Venting facilities with adequate, existing boom arm (but no flare tip);
2. Venting facilities with inadequate boom arm, but without the capability of supporting boom arm and flare with minor structural reinforcement; and

3. Venting facilities with inadequate boom arm, but without the capability of supporting boom arm and flare; would likely need the new flaring structure installed as a tripod or caisson type facility.<sup>1</sup>

Costs of retrofits were estimated by the OOC to be \$2–4 million per installation in 2015.

### Applicability

Flares can be applied to all vented emissions of combustible gas with minimal sulfur content.

Flare systems apply to platforms with significant vented volumes from compressor outages or well unloading. The installation of flare systems is common practice for all new facilities with processing equipment.

Fifty-three of 852 leases reported vented volumes in 2014–2015 that averaged > 50 MCF/D, which is the threshold rule of thumb that triggers an economic evaluation for capturing the vented gas. The causes of vented gas would require further analysis to determine whether a flare addition would be applicable.

In addition, temporary or portable flare stacks (commonly used on shore) might be considered for planned depressurizing of pipelines for repair and maintenance work.

### Emission Reduction Potential

Methane emissions reduction is uniquely dependent on the types and sizes of sources and the methane content of the flared gas. Wellhead gas may range from 70 to 90 percent methane.

### Economic Analysis

Methane emissions reductions would need to be converted to value using the social cost of carbon to determine if a flare is economic, since there are no revenues from the combusted gas.

### References

1. BSEE OOC General Meeting Presentation given in New Orleans, LA in 2011, <https://www.bsee.gov/sites/bsee.gov/files/public-comments/safety/final-ooc-12-3-2013-presentation-saucier.pdf>

This technology briefing is based on research conducted for the following study: The EPA Natural Gas STAR Program: Recommended Technologies and Practices – [Install Flares](#)

### Applicable Application(s)

- New Construction
- Retrofit

### Applicable Modification(s)

- Hardware/Equipment
- Process

### Applicable Structure(s)

- Well-Only Platforms
- Fixed Platforms
- Floating Platforms (SPAR/TLP/CT/Semi-Sub)

### Applicable Equipment Type(s)

- Flare
- Cold Vent

## LIQUID REMOVAL THROUGH GAS LIFT SYSTEM

[RETURN](#)

### Technology Overview

Many wells do not have sufficient pressure to allow oil or gas to rise to the surface naturally. A common approach to temporarily restoring flow is to flow the well to atmospheric pressure (flare or vent to “unload” the liquids), which produces substantial emissions. One alternative commonly used both onshore and offshore to overcome the back pressure on the reservoir caused by liquid loading is a gas lift system. Compressed gas is injected down the annulus (space between the tubing and casing strings), through a valve or orifice at the bottom of the tubing and into the liquid that has built up in the tubing. The injected gas supplements the formation gas to form bubbles within the oil and water, which reduces viscosity and density. By lightening the liquid column with gas bubbles, the reservoir pressure is then able to lift the liquid column to the surface. For dewatering gas wells, the volume of injected gas is designed such that, in combination with the formation gas, the critical rate to lift the water is exceeded.

A gas lift system works by injecting compressed gas down the casing tubing annulus, where the gas can enter the tubing through one or more entry points known as gas lift valves. These valves are installed in “side pocket mandrels” using wire line, which allows them to be easily changed as the reservoir conditions change. The mandrels are installed in the well as part of the tubing string.

Gas lift valves are utilized to adjust the rate and pressure at which gas is injected into the well. This is accomplished by varying the size of the orifice to achieve the minimum gas velocity required for fluids to flow (the critical velocity) and by changing the pressure setting of the valve so that it opens when the desired differential between the reservoir and well bore pressures is achieved. Each gas lift valve has an allowable injection pressure, which causes the valve to open and gas to flow to the desired location. Check valves located within the gas lift valve allow only one-directional flow through the valve.

Gas lift systems can be either continuous or intermittent flow. The majority of wells utilize continuous gas lift gas flow to achieve a steady flow of fluids to the surface; however, this requires a reliable source of high-pressure gas. In most cases, gas resources decline before full depletion of a zone is complete.

Continuous flow gas lift is recommended for high-volume wells with a high-static bottom-hole pressure, offshore wells with strong water drive, or formations being produced via water flood that have a high productivity index and high gas/oil ratios.

For intermittent flow, gas is periodically injected into the production string to displace slugs of fluid. Intermittent flow may cause gas and liquid handling complications on the surface. Also, the large variations in pressure caused by intermittent injection may lead to sand production. Wells are converted from continuous to intermittent gas lift when the bottom-hole pressure declines to the point that it will no longer support continuous lift.

The ideal gas lift system involves the continuous injection of gas into the fluid column at a consistent rate and pressure to ensure stable liquid flow rate from the reservoir. This can only be accomplished when a sufficient volume of high-pressure gas is readily available, such as from other wells on the same production facility or from a gas compressor. The gas typically used for gas lift systems is recycled gas that was produced from the well(s).

Intermittent flow gas lift systems are not recommended for wells producing more than 150 bbl/day with 2-3/8" tubing, 250bbl/day with 2-7/8" tubing, 300bbl/day with 3-1/2" tubing, or in wells with high bottom-hole pressures and low productivity indices or vice versa. Many intermittent flow systems are utilized for depleted wells, which previously used continuous flow gas lift, or for gas wells that have begun to produce water.

Gas lift systems are highly reliable, flexible, and robust and can operate for the life of the well. The ability to change valves also allows adaptation for production changes.<sup>2,3</sup>

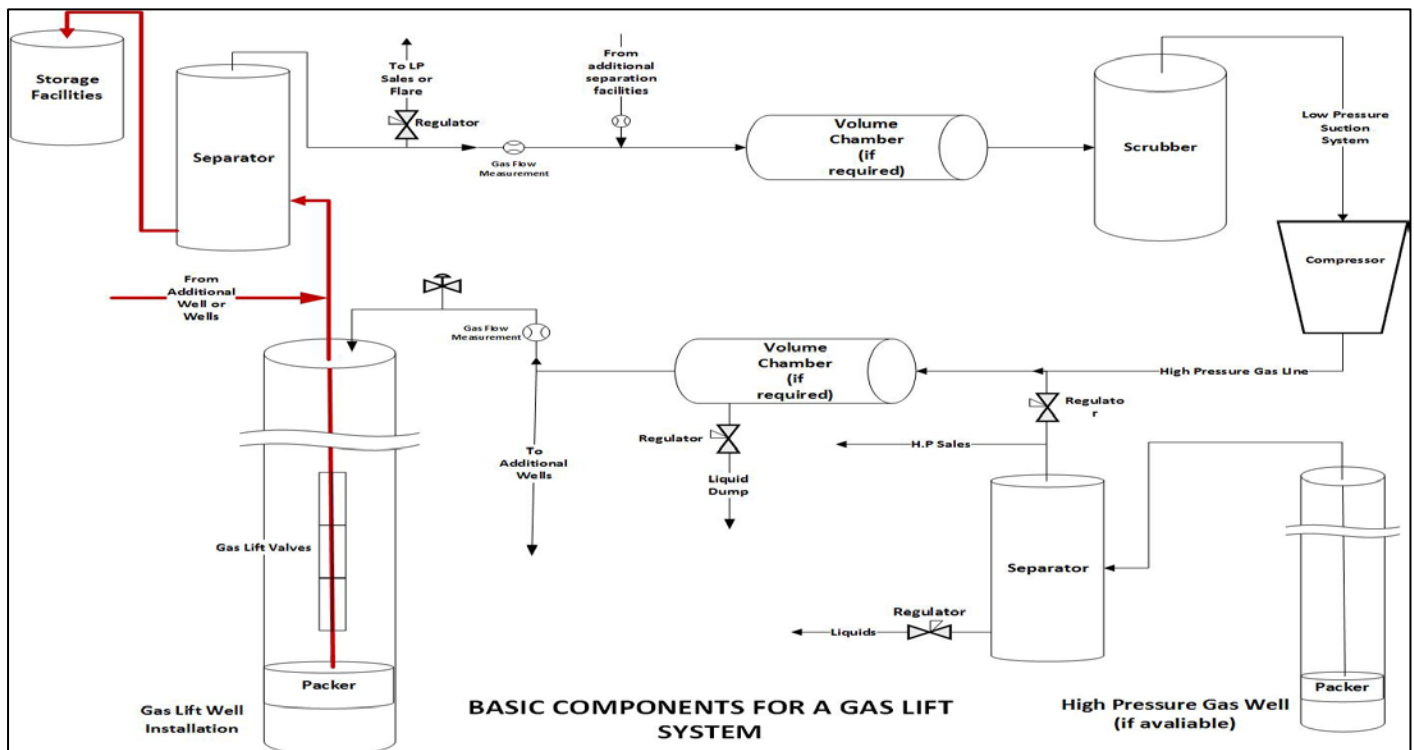

Exhibit 3: Typical Gas Lift System source: Argonne Vent/Flare Research Team

## Operation and Implementation

Designing a gas lift system to optimize production is accomplished by determining the production potential of each well. Based on the available gas pressure and volume, engineers can determine the optimum production rate and gas lift allocation required.

Interactions of all parts of the production system must be considered individually for each well. Flow-line and down-hole tubular sizes and lengths, processing equipment, gas and compressor availability, fluid composition, and other factors impact the gas lift efficiency and production.

Today, optimization software programs can be utilized to design the gas lift system and test different injection rates.

Conditions in the well are constantly changing. By pairing computer optimization technologies with real-time data, the optimal amount of gas lift gas for optimal production can be determined.

Different injection systems may be required based on the dynamics of the well. The most common configuration includes a packer and gas lift valves,<sup>3</sup> but the configuration may also be designed in combination with a free traveling plunger.<sup>5</sup>

## Applicability

Gas lift systems can only be utilized in situations where there is sufficient gas pressure to lift the fluids and where the reservoir properties and pressures are such that fluids can flow through the formation into the well bore at an economic rate.

For a gas lift system to function properly, sufficient compression is required to produce gas with high enough pressure to overcome the hydrostatic pressure exerted by the standing column of fluid in the well bore.

Gas lift mandrels and valves will be required during well construction, and if retrofitting an existing facility, well modifications will be required to add these gas lift mandrels and valves.

## Emission Reduction Potential

Emission reductions are realized by avoiding well unloading to the flare or vent. The frequency of well unloads is dependent on the reservoir pressure, well depth, liquid loading rate, and other factors.

In addition to the emission benefits, often the well can be produced longer and yield greater cumulative recovery.

## Economic Analysis

There are moderate costs associated with the implementation of a gas lift system.<sup>4</sup>

### Applicable Application(s)

- New Construction
- Retrofit

### Applicable Modification(s)

- Hardware/Equipment
- Process

### Applicable Structure(s)

- Well-Only Platforms
- Fixed Platforms
- Floating Platforms (SPAR/TLP/CT/Semi-Sub)

### Applicable Equipment Type(s)

- Flare
- Cold Vent

The economic viability of utilizing gas lift as an artificial lift system is dependent on whether there is a sufficient amount of gas needed for the injection.<sup>3</sup>

Another factor impacting the economics of a gas lift system is whether additional compression capacity will need to be added to the facility to produce gas with high enough pressure.

The costs associated with the installation of gas lift valves and mandrels must also be accounted for in the implementation cost.

When considering the costs of gas lift, it is also important to include the economic benefits that may be realized from improved production of the well.

Gas lift will likely only be economically attractive when the economics include the improved recovery. To capture the economic benefits and also gain the advantages of reduced emissions, the gas lift needs to be implemented at the right time to minimize the number of times gas is vented or flared to unload the well.

## References

1. Rigzone. How Does Artificial Lift Work? [http://www.rigzone.com/training/insight.asp?insight\\_id=315](http://www.rigzone.com/training/insight.asp?insight_id=315) (Accessed 5 May 2016).
2. Schlumberger. Gas Lift. [http://www.slb.com/resources/oilfield\\_review/~media/Files/resources/oilfield\\_review/defining\\_series/Defining%20Gas%20Lift.ashx](http://www.slb.com/resources/oilfield_review/~media/Files/resources/oilfield_review/defining_series/Defining%20Gas%20Lift.ashx) (accessed 5 May 2016).
3. American Completion Tools “Gas Lift Equipment” <http://americancompletiontools.com/act-cat/COMPLETION%20SYSTEMS.pdf>
4. Part III: Flare Reduction Project Family. *Oil and Natural Gas Industry Guidelines for*

*Greenhouse Gas Reduction Projects.* [Print] 2009, <http://www.api.org/~media/files/ehs/climate-change/ghgreductionprojectsflares.pdf?la=en> (accessed 5 May 2016).

5. Lea, James F., Nickens, Henry V., Wells, Mike (2011) *Gas Well Deliquification.* Gulf Professional Publishing, 2011.



## MICROTURBINES USE FLARE GAS FOR POWER GENERATION

[RETURN](#)

### Technology Overview

Capstone C65 microturbines (see Exhibit 1) are smaller than equivalent generators by 33% and can reliably power onshore and offshore operations using unprocessed wellhead gas (economic or flare, sweet or up to 7% sour) to generate three-phase, load-following, continuous power. Capstone’s patented air-bearing technology creates ultra-low emissions and reliable electrical generation using raw natural gas with minimal gas treatment.

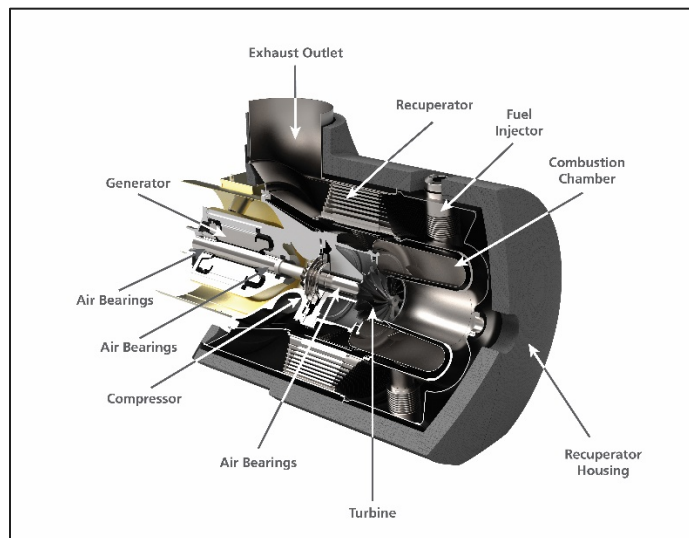

Exhibit 1: Cutaway of Microturbine<sup>1</sup>

programming the load sharing system or adding a new load sharing system.

Alternatively, a standalone unit could be used to power a certain segment of the electrical system. Installation would entail fuel gas supply piping and controls, as well as electrical system tie-in or design in addition to the microturbine unit itself. Costs for the installation would also need to include engineering design, construction labor, and transportation.



Exhibit 2: Example of an Offshore Installation<sup>2</sup>

### Operation and Implementation

Incorporating a microturbine power generation system into an existing power system would require

### Applicability

For the benefit of burning otherwise routinely vented gas, smaller-sized microturbines could be applicable offshore if there is space available. The power generation that they provide would need to be used to power a less critical electric demand or a load bank that could consume the excess power.

Microturbines can be bundled together to produce greater MW output; however, the size makes them difficult to retrofit for an offshore platform. On new installations, the microturbine may be feasible. Some case studies on offshore platforms (see Exhibit 2) are presented in the manufacturer’s website.

### Emission Reduction Potential

Each 30 kW size would use approximately 10 MCF/D of fuel and use gas that would otherwise be flared.

If there is an available stream of normally flared or vented gas, the annual emission reduction would be ~ 3000 MCF depending on runtime.

### Economic Analysis

The economic analysis would need to account for the reduced operating costs in addition to the reduction of lease use gas currently used to fuel the power generators on the platform.

### References

1. Capstone Turbine Corporation, with permission [cfinch@capstoneturbine.com](mailto:cfinch@capstoneturbine.com).
2. MicroTurbine Applications for the Offshore Oil and Gas Industry. <https://www3.epa.gov/gasstar/documents/workshops/2008-tech-transfer/neworleans5.pdf> (accessed 23 Aug 2016).

This technology briefing is based on vendor literature provided by Capstone Turbine Corporation – [Microturbines](#)

### Applicable Application(s)

- New Construction
- Retrofit

### Applicable Modification(s)

- Hardware/Equipment
- Process

### Applicable Structure(s)

- Well-Only Platforms
- Fixed Platforms
- Floating Platforms (SPAR/TLP/CT/Semi-Sub)

### Applicable Equipment Type(s)

- Flare
- Cold Vent

## WELL UNLOADING THROUGH ELECTRIC SUBMERSIBLE PUMPS

[RETURN](#)

### Technology Overview

Many wells do not have sufficient pressure to allow oil or gas to rise to the surface naturally. A common approach to temporarily restore flow (when gas compression to lower the surface flowing pressure is not available) is to flow the well to atmospheric pressure (flare or vent to “unload” the liquids), which produces substantial emissions. In situations like these, artificial lift methods can be employed to enable well fluids to flow to the surface. These techniques become even more useful as pressure in the reservoir is depleted over time from production.

The artificial lift method most commonly used offshore is the gas lift system, however when a gas lift system has proven ineffective at a particular well other options are available for artificial lift methods, including an electric submersible pump (ESP) system.

The ESP system is relatively efficient and can be designed to function at a wide range of volumes spanning from 150 barrels per day to 150,000 barrels per day (combined oil & water) with a variable speed drive (VSD) extending this range. However, once selected for a particular set of conditions, the pump capacity range will be a small portion of that range.

The main downhole components of an ESP system include a multi-staged centrifugal pump, three-phase induction motor, seal-chamber section, sometimes a gas separator and a power cable. The surface equipment includes a power source, transformer and equipment for controlling the speed and monitoring power usage.

ESP systems are applicable in deep wells but are limited to casing sizes equal to or greater than 4-1/2”

Outside Diameter (OD). A single ESP pump section is approximately 30 feet long. An ESP system may be composed of several sections. Because of its length the system must be installed in a relatively straight part of the hole but can be used at any angle from vertical to horizontal. The more severe the angle, the more care must be taken to select the correct material for thrust bearings to avoid excessive wear.

ESP systems are ideal for high rate, low pressure wells and can provide as much as 15,000 feet of lift and can be designed for temperatures up to 500 deg. F. The range of available construction materials allows them to be used in harsh, corrosive environments. They are attractive for use offshore because of their small footprint and low profile – only the VSD and cabling is visible on the surface.

Efficiency suffers in the presence of high gas liquid ratio (when greater than 10% of the pump intake volume is gas), high solids content, and/or high viscosity fluids.

Implementing an ESP system will allow increased production while also allowing reduced emissions since a low pressure system (e.g. a flare or vent) is no longer required for the well to flow upon restart.

### Operating & Implementation

The ESP system is typically considered a relatively low maintenance system because there is very little equipment on the surface to maintain and the downhole equipment is not accessible without using a rig to pull the tubing to retrieve the pump. The costs associated with fixing, replacing, and installing any of the downhole equipment are high and will result in lost production since the well must be killed.

System failure is often associated with electrical failure of the motor or the cable from the surface to the pump.

As flow from the well declines modifications must be made to the ESP system, plus the system often has only a 1 to 2 year service life due to electric system issues occurring in the annulus. In some environments, the service life is measured in months.

### Applicability

ESP systems are considered high volume systems, so sufficient fluid flow is necessary.

They also have the ability to function at extreme depths and temperatures relative to other artificial lift systems, though deeper applications invite electrical system reliability challenges.

ESP systems can be utilized in highly deviated wells as long as the system itself can be installed in a straight section of casing.

ESP systems are sometimes installed at the first production of a well if reservoir pressure is insufficient to lift the fluids to the surface at the maximum efficient rate. More often the systems are installed after unassisted production from the well has caused reservoir pressure to decline and rates have fallen below what can be achieved by the use of an ESP.

ESP systems can function in wells with low bottomhole pressure however high fractions of gas (greater than 10 percent volume at the pump intake) significantly impact the efficiency of the system. Further, care must be taken to prevent the pumping fluid level from falling to the level of the pump. This causes the system to overheat and fail.

The ESP system can only tolerate minimal amounts of sand production since any solids will cause wear to the system.

## Emission Reduction Potential

Production gains are achieved through increased flow of fluids from the well through the implementation of an ESP system. A well may also remain economic to a higher water oil ratio thereby increasing the total oil recovery. In addition, the recovery efficiency may be improved by lowering the abandonment pressure.

When well fluids need to be routed to a low pressure system (e.g. flare or vent) in order to get the well to flow upon restarting, an ESP system can allow the well to be restarted at normal system pressures which significantly reduces the amount of vented and flared emissions.

## Economic Analysis

Factors such as the required depth, tubing/casing size, operating pressure, production capacity, and wellbore conditions will impact the cost and benefits of implementing an ESP system.

## References

1. Electric Submersible Pumps in the Oil and Gas Industry.  
<http://www.pumpsandsystems.com/topics/pumps/pumps/electric-submersible-pumps-oil-and-gas-industry> (accessed 10 May 2016).
2. Offshore Magazine. Artificial Lift and Pressure Boosting Options for Production Enhancement.  
<http://www.offshore-mag.com/articles/print/volume-61/issue-10/news/artificial-lift-and-pressure-boosting-options-for-production-enhancement.html> (accessed 23 Aug 2016).

### Applicable Application(s)

- New Construction
- Retrofit

### Applicable Modification(s)

- Hardware/Equipment
- Process

### Applicable Structure(s)

- Well-Only Platforms
- Fixed Platforms
- Floating Platforms (SPAR/TLP/CT/Semi-Sub)

### Applicable Equipment Type(s)

- Flare
- Cold Vent

## DOWNHOLE JET PUMP FOR WELL UNLOADING

[RETURN](#)

### Technology Overview

Many wells do not have sufficient pressure to allow oil or gas to rise to the surface naturally. In situations like these, artificial lift methods must be employed to encourage the flow of oil to the surface. These techniques become even more useful as pressure in the reservoir is depleted over time from production.

The artificial lift method most commonly used offshore is the gas lift system; however, when a gas lift system has proven ineffective at a particular well, other options are available, including a jet pump (part of the hydraulic lift class of pumps). Jet pump systems transmit power downhole by means of pressurized power fluid flowing in well bore tubulars. The hydraulic transmission of power downhole can be accomplished with reasonable efficiency. Power fluid can be either oil or water, with water providing better efficiency due to its lower viscosity.<sup>3</sup>

The [downhole pump](#) acts as a transformer, utilizing the Venturi effect to convert the pressurized power fluid to a high-velocity jet. The resulting pressure drop brings formation fluid into the jet pump. The power fluid mixes directly with well fluids. In this turbulent mixing, momentum and energy from the power fluid are added to the produced fluids. The hydraulic fluid can be either produced oil or water. A tank at the surface provides surge capacity and is usually part of the cleaning system used to condition the well fluids. Appropriate control valves and piping complete the system.

Jet pumps are installed in the tubing, and the mixed power fluid and produced fluid return either up the annular space or up a second string of tubing (conventional or standard configuration). The power fluid can also be pumped down either the annulus or

the second tubing string, with the mixed fluid returning up the tubing string in which the jet pump is installed (reverse configuration).

There are no moving parts in the well for the jet pump to function, and the bottom hole assembly can be recovered without a rig by either circulating it to the surface using power fluid where the BHA is caught in the tree above the master valve or by using wire line (slick line). The BHA can then be repaired, replaced, or resized. By varying the sizes of nozzles and throats in the BHA and varying the amount of power fluid supplied to the pump, jet pumps can function in volumes as small as 50 barrels per day and up to volumes as high as 15,000 barrels per day. Varying these parameters and the materials and configurations of the pump system also accommodate changing well and reservoir conditions.

### Operation and Implementation

The general materials utilized to construct the nozzle and throat in a jet pump are tungsten carbide or ceramic materials, which make these pumps long lasting and durable. Chemicals can also be added to the power fluid to prevent the buildup of scale, dissolve salt deposits, and prevent corrosion.

Typically, the operational life of the jet pump is 4 years. If repairs are required, jet pumps can be repaired onsite without the use of a rig, which allows less downtime and reduced associated repair costs.

When operating jet pumps, it is important to maintain a specific balance between the production flow rate, pump intake pressure, and return line flow area to avoid cavitation in the pump.



### Applicability

Since no moving components are required for the jet pump to function, these pumps are rugged and can be exposed to abrasive and corrosive environments. Jet pumps can also operate in high gas volumes and high solids production.

Jet pumps can be run in wells that are highly deviated and can also function in very heavy and viscous oil or with high volumes of paraffin. Jet pumps can also operate at higher volumes relative to most other lift methods. With the correct type of elastomers, jet pumps can operate at high temperatures reaching 500 degrees Fahrenheit.

Determining the installation design of the jet pump requires extensive and complicated calculations and thus computational software should be utilized to perform the calculations.

The costs of the initial installation of the jet pump may be extensive since a second tubing string, dual string packer, and two surface controlled subsurface safety valves must be installed to run a jet pump offshore. There is also the additional cost of the power fluid pump, additional pipeline and valves for injection, wellhead reconfiguration and equipment to condition the power fluid (remove

solids, entrained gas, etc.) prior to injection.

The jet pump also requires sufficient available equipment capacity for the power fluid to be pumped downhole. If water is used, it should be produced water to avoid scale formation that commonly occurs when seawater is mixed with produced water.

### Emission Reduction Potential

Production gains are achieved through increased flow of fluids from the well through the implementation of a jet pump.

When well fluids need to be routed to a low-pressure system (e.g., flare or vent) in order to get the restarted well to flow, implementing a jet pump system allows the well to be restarted at normal system pressures. This significantly reduces the amount of vented and flared emissions.

### Economic Analysis

Factors such as the required depth, operating pressure, production capacity, and well bore conditions will impact the cost and benefits of implementing a jet pump.

The total cost of the topside equipment (such as power fluid pump, surge tanks, and fluid filters) can be shared among several wells

with the addition of some valves and headers, thereby lowering the cost of jet-pump use for each individual well.

#### Applicable Application(s)

- New Construction
- Retrofit

#### Applicable Modification(s)

- Hardware/Equipment
- Process

#### Applicable Structure(s)

- Well-Only Platforms
- Fixed Platforms
- Floating Platforms (SPAR/TLP/CT/Semi-Sub)

#### Applicable Equipment Type(s)

- Flare
- Cold Vent

### References

1. Diverse Energy Systems. Fundamentals – How the Jet Pump Works. <http://www.flowfastjetpumps.com/> (accessed 23 Aug 2016).

## MONITORING AND REPAIRING LEAKING FLARE/VENT CONTROL VALVES

[RETURN](#)

### Technology Overview

When operating a flare system, a small amount of header purge gas is maintained to ensure there is no possibility of reverse flow of air into the flare system. In addition, a small amount of pilot gas is used to maintain the lit flare.

Other sources of gas to the flare or vent system are pressure relief valves, commonly called Pressure Safety Valves (PSV's). These are normally closed valves, but they can leak through to the flare header.

Pressure control valves are used for intermittent flaring and venting operations from processing equipment and prevent process upsets from putting demand on the safety system (i.e., high-pressure shutdown devices or PSVs).

After some time, the control valve(s) may begin to leak through and release gas to the flare or vent system continuously. This will contribute to vented and flared volumes. Since not all platforms are

required to have meters, these emissions may go unreported on many facilities.

To avoid these additional emissions, increasing the monitoring of the flare and vent control valves will allow better detection of leaks and decreased flare and vent emissions upon repair of a leaking valve.

### Operation and Implementation

The costs associated with monitoring and repairing leaking flare and vent control valves will be relatively small, except in higher-pressure applications with special, high-complexity, low-noise control valve trims. The costs associated with monitoring for leaks will depend on the type of monitoring system utilized. For platforms which are already required to have meters installed for measuring vented and flared volumes, monitoring capability already exists.

If a metering system has not previously been installed on the platform, there will be costs associated with installing the metering systems.



Other methods can also be employed for monitoring leaked volumes, including temperature monitoring or different acoustic, optical, and infrared technologies.<sup>1</sup>

There will also be associated costs with repairing or replacing the control valve if leaks are detected. When making any repairs to the flare system, there will be associated downtime, and the entire system will need to be purged of any gas before any repairs can be made.<sup>2</sup>

### Applicability

Monitoring and repairing the flare and vent control valves is important for any facility that has flare and/or vent control valves or pressure safety valves; however, detection methods are required to determine if gas is in fact leaking from the valve(s). This can easily be accomplished when a metering system is available on the platform and can determine if emissions are occurring when the valve is closed and no emissions are intended.

### Emission Reduction Potential

Leaking flare or vent control valves are a contributor to (sometimes undetected) flared and vented volumes. Through monitoring and repairing control valves associated with the flare or vent system, the volume of gas allowed to avoidably escape through the system can be reduced.

### References

1. Passing Valves (leakage).  
<http://www.ipieca.org/energyefficiency/solutions/60391> (accessed 17 May 2016).
2. 5.4 Maintenance and Repair.  
<http://www.argoflares.com/research/introduction/flare-inspection-maintenance/maintenance-and-repair/> (accessed 17 May 2016).

#### Applicable Application(s)

- New Construction
- Retrofit

#### Applicable Modification(s)

- Hardware/Equipment
- Process

#### Applicable Structure(s)

- Well-Only Platforms
- Fixed Platforms
- Floating Platforms (SPAR/TLP/CT/Semi-Sub)

#### Applicable Equipment Type(s)

- Flare
- Cold Vent

## INSTALL REDUNDANT COMPRESSORS

[RETURN](#)

### Technology Overview

Compressors are used throughout the offshore production industry to recover flash gas (natural gas) from production wells and to export it through pipelines. Exhibit 1 shows a typical offshore production train where compressors are used to recover gas from four system pressures (Intermediate Pressure–IP, Low Pressure–FWKO/LP, Bulk Oil Treater–BOT, and the Dry Oil Tank–DOT). The range of horsepower per unit is 40 HP to 15,000 HP.

Booster gas compressors are typically the highest-pressure stage of compression and discharge at pressures sufficient to export into the gas export pipeline (after dehydration). Booster gas compressors usually have high capacity, so centrifugal compressors are the most common type of BGC.

Field gas compressors (FGCs) recover flash gas from produced oil at intermediate (400–600 psig) and low (100–200 psig) system pressures. Both centrifugal and reciprocating compressors can be found in FGC service. Generally, more recent, larger-production-rate platforms prefer centrifugal compressors over reciprocating compressors because of higher reliability. Centrifugal compressors are most commonly driven with natural gas turbines, and reciprocating compressors are either driven by electric motors or gas-powered reciprocating engines.

Vapor recovery units (VRUs) recover gas from the lowest system pressures including the Bulk Oil Treater (30–60 psig) and Dry Oil Tank (< 15 psig). These are lower-volume compressors and are typically either reciprocating compressors or screw

compressors. An electric motor is the most common VRU driver; however, there are many natural gas reciprocating engines driving VRU compressors.

### Operation and Implementation

Unless there are redundant compressors at the same system pressure, all compressors must run any time the wells are flowing to avoid flaring. When there are redundant or multiple compressors at the same system pressure, the number of compressors and the load on the running compressors will depend on the production rate.

Platform space and weight constraints may limit the possibility of adding compression after the initial design. Even if there is space and if the weight can be accommodated, the power supply or fuel gas supply and other auxiliary systems (i.e., seal gas, seal oil, safety system, and piping) may not be expandable to accommodate the new compression system.

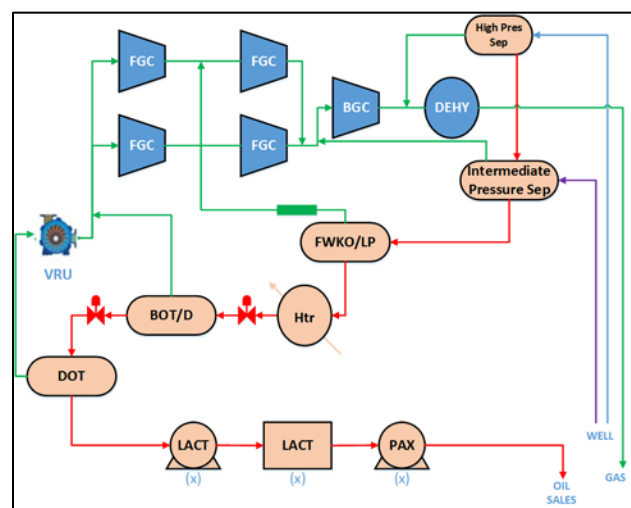

Exhibit 1: Typical Offshore Production Train<sup>1</sup>

The cost of adding a centrifugal compressor system is likely to exceed \$25 million. A smaller, reciprocating compressor or screw compressor may be less, but is likely to cost more than \$10 million.

In addition to capital costs, additional compression will add to operating costs, such as fuel and repair and maintenance.

### Applicability

The ideal time to install redundant (>100% of design capacity) compression is during the original platform design and construction. Even systems with two units at 50% capacity or three units at 33% capacity would be preferred over one unit at 100%. These arrangements would also be helpful during platform startup, when the production rates are expected to be very low (< 10% of peak design gas rates).

In some rare cases, existing compression capacity can be reconfigured to allow the compressor to operate in different system pressure ranges. For example, a field gas compressor may be configured (and connected) as a VRU. This should be evaluated if compression is being considered on a new platform or an existing platform.

### Emission Reduction Potential

Since flaring or venting is limited by current regulations, the larger benefit in adding redundant compression is in reducing production deferment. However, there is still significant flaring and venting associated with compression downtime within the current limits of 48 continuous hours or 144 hours during the month.

### Economic Analysis

The economics of adding compression will depend on whether the added compression will lower the abandonment pressure for the wells, lower the system pressure and accelerate production, reduce production deferment due to compressor downtime, or allow recovery of flared or vented gas during compressor downtime.

### References

1. Shell Presentation in Robert, LA October 2015.

### Applicable Application(s)

- New Construction
- Retrofit

### Applicable Modification(s)

- Hardware/Equipment
- Process

### Applicable Structure(s)

- Well-Only Platforms
- Fixed Platforms
- Floating Platforms (SPAR/TLP/CT/Semi-Sub)

### Applicable Equipment Type(s)

- Flare
- Cold Vent

## APPENDIX III

# CHANGE TO OGOR-B REPORTING REQUIREMENTS FOR FLARING AND VENTING, FORM MMS-405

---

THIS REPORT WAS INADVERTENTLY DISSEMINATED IN THE PUBLIC DOMAIN/ONLINE SINCE 07/2021 WITHOUT A DISCLAIMER. DISCLAIMER HAS BEEN ADDED  
– “THIS INFORMATION IS DISTRIBUTED SOLELY FOR THE PURPOSE OF PEER REVIEW UNDER APPLICABLE INFORMATION QUALITY GUIDELINES. IT HAS NOT BEEN FORMALLY DISSEMINATED BY BSEE. IT DOES NOT REPRESENT AND SHOULD NOT BE CONSTRUED TO REPRESENT ANY AGENCY DETERMINATION OR POLICY.”



## United States Department of the Interior



MINERALS MANAGEMENT SERVICE  
Minerals Revenue Management  
P.O. Box 17110  
Denver, Colorado 80217-0110  
[www.mrm.mms.gov](http://www.mrm.mms.gov)

Dear Reporter:

MAY - 7 2010

Subject: Reporting requirements for reporting Flaring and Venting of oil-well gas and gas-well gas on the Oil and Gas Operations Report (OGOR), Form MMS-4054.

This letter notifies you of a change in OGOR reporting for flaring and venting of oil-well and gas-well gas on the OGOR-B. This reporting requirement will identify the flaring and venting volumes separately in order to validate the volumes reported on the OGOR with field records.

Beginning with the **July, 2010** production month **due September 15, 2010**, **onshore and offshore reporters** must report as follows on the OGOR-B:

1. Flared oil-well gas using the disposition code 21.
2. Flared gas-well gas using the disposition code 22.
3. Vented oil-well gas using the new disposition code 61.
4. Vented gas-well gas using the new disposition code 62.

**Onshore** reporters are required to report the appropriate disposition code. The "Metering Point" field is optional.

**Offshore** reporters are required to report the appropriate disposition code. In addition, for facilities that process more than 2,000 BOPD (barrels of oil per day), enter the approved Facility/Measurement Point (FMP) number in the "Metering Point" field beginning with the July, 2010 production month. The offshore FMP numbers for facilities located in the Gulf of Mexico Region will be available after August 1, 2010, and can be obtained by using the Fast Facts. "Facility/Measurement Points (FMP)" online query located at <http://www.gomr.mms.gov/homepg/fastfacts/fastfacts.html>. The offshore FMP numbers for facilities located in the Pacific Region will be mailed to you beginning August 1, 2010.

If you have questions regarding these reporting requirements, please contact your MRM company contact at 800-525-7922, and enter "1," plus the extension number of your company contact. If you have questions regarding the offshore FMP numbers, please contact Ms. Kathy Bell at 504-736-2838 for the Gulf of Mexico Region or Mr. Obediah Racicot at 805-389-7797 for the Pacific Region.

Sincerely,

*Louise Williams*

Louise Williams  
Manager, Production Accounting  
and Verification Services  
Financial Management

U.S. DEPARTMENT OF THE INTERIOR  
 Office of Natural Resources Revenue

REPORTER USE

ONRR USE

**OIL AND GAS OPERATIONS REPORT  
 PART B - PRODUCT DISPOSITION  
 (OGOR-B)**

INDIAN

REPORT TYPE: <input type="checkbox"/> ORIGINAL <input type="checkbox"/> MODIFY (DELETE/ADD BY LINE) <input type="checkbox"/> REPLACE (OVERLAY PREVIOUS REPORT)	ONRR LEASE/AGREEMENT NUMBER: (11)	OR	AGENCY LEASE/AGREEMENT NUMBER: (25)
PRODUCTION MONTH: (6) MMCCYY	ONRR OPERATOR NUMBER: (5)	OPERATOR NAME: (30)	
OPERATOR LEASE/AGREEMENT NAME: (30)		OPERATOR LEASE/AGREEMENT NUMBER: (20)	

LINE NUMBER	ACTION CODE (1)	DISPOSITION CODE (4)	METERING POINT NUMBER (11)	GAS PLANT NUMBER (11)	API GRAVITY 99.9 (3)	BTU 9999 (4)	DISPOSITION VOLUMES			
							OIL/CONDENSATE (BBL) (9)	GAS (MCF) (9)	WATER (BBL) (9)	
1					■					
2					■					
3					■					
4					■					
5					■					
6					■					
7					■					
8					■					
9					■					
10					■					
<b>TOTAL DISPOSITIONS (9)</b>										

CONTACT NAME: (First, M.I., Last) (30)	TELEPHONE NUMBER: (10) (     ) (     -     )	EXTENSION NUMBER: (5) (     )
AUTHORIZING SIGNATURE	DATE: (8) MMDDCCYY	COMMENTS: (60)

## **INSTRUCTIONS OIL AND GAS OPERATIONS REPORT PART B – PRODUCT DISPOSITION (OGOR-B)**

### **WHO MUST FILE**

- A separate report must be filed monthly (unless non-monthly reporting has been approved) by each designated operator of an offshore OCS, onshore, or Indian lease/agreement that contains active wells. Wells must be reported from the time active drilling is concluded and up until the status is changed to permanently abandoned or until inventory has been disposed of.

### **WHEN TO FILE**

- Reports must be received by the 15th of the second month following the production month (e.g., the report for June is due on August 15).
- You are required to report electronically under 30 CFR 1210 (2012) (formerly 30 CFR 210) unless ONRR approved you to report on paper.

### **WHERE TO FILE**

Reports must be filed with:

Office of Natural Resources Revenue  
PO Box 25627  
Denver CO 80225-0627

**REFER TO THE PRODUCTION REPORTER HANDBOOK PRIOR TO COMPLETING THIS FORM.**

The Paperwork Reduction Act of 1995 (PRA) Statement: The PRA (44 U.S.C. 3501 et seq.) requires us to inform you that we collect this information to corroborate oil and gas production and disposition data with sales and royalty data. Responses are mandatory (43 U.S.C. 1334). Proprietary information is protected in accordance with the standards established by the Federal Oil and Gas Royalty Management Act of 1982 (30 U.S.C. 1733), the Freedom of Information Act [5 U.S.C.552(b)(4)], and the Department regulations (43 CFR 2). An agency may not conduct or sponsor, and a person is not required to respond to, a collection of information unless it displays a currently valid OMB Control Number. Public reporting burden for this form is estimated at an average of 5 minutes/hour per report for electronic and manual reporting, including the time for reviewing instructions; gathering and maintaining data; and completing and reviewing the form. Direct your comments regarding the burden estimate or any other aspect of this form to the Office of Natural Resources Revenue, Attention: Rules & Regs Team, MS 61030A, PO Box 25165, Denver CO 80225-0165.



THIS REPORT WAS INADVERTENTLY DISSEMINATED IN THE PUBLIC DOMAIN/ONLINE SINCE 07/2021 WITHOUT A DISCLAIMER. DISCLAIMER HAS BEEN ADDED  
– “THIS INFORMATION IS DISTRIBUTED SOLELY FOR THE PURPOSE OF PEER REVIEW UNDER APPLICABLE INFORMATION QUALITY GUIDELINES. IT HAS NOT BEEN FORMALLY DISSEMINATED BY BSEE. IT DOES NOT REPRESENT AND SHOULD NOT BE CONSTRUED TO REPRESENT ANY AGENCY DETERMINATION OR POLICY.”

## About Argonne National Laboratory

Argonne is a U. S. Department of Energy laboratory managed by UChicago Argonne, LLC under contract DE-AC02-06CH11357. The Laboratory’s main facility is outside Chicago, at 9700 South Cass Avenue, Argonne, Illinois 60439. For information about Argonne and its pioneering science and technology programs, see [www.anl.gov](http://www.anl.gov).

## Disclaimer

This report was prepared as an account of work sponsored by an agency of the United States Government. Neither the United States Government nor any agency thereof, nor UChicago Argonne, LLC, nor any of their employees or officers, makes any warranty, express or implied, or assumes any legal liability or responsibility for the accuracy, completeness, or usefulness of any information, apparatus, product, or process disclosed, or represents that its use would not infringe privately owned rights. Reference herein to any specific commercial product, process, or service by trade name, trademark, manufacturer, or otherwise, does not necessarily constitute or imply its endorsement, recommendation, or favoring by the United States Government or any agency thereof. The views and opinions of document authors expressed herein do not necessarily state or reflect those of the United States Government or any agency thereof, Argonne National Laboratory, or UChicago Argonne, LLC.

Bureau of Safety and Environmental Enforcement and Argonne National Laboratory logos used with permission.

