



# Decommissioning Methodology and Cost Evaluation

**BPA No. E13PA00010**

**Call Order No. E14PB00056**

## **Prepared for**

U.S. Department of the Interior  
Bureau of Safety and Environmental Enforcement  
45600 Woodland Road  
Sterling, Virginia 20166

## **Prepared by**

Prepared by ICF Incorporated, LLC in collaboration with the  
Bureau of Safety and Environmental Enforcement  
9300 Lee Highway  
Fairfax VA 22031

blank  
page

## Contents

<b>Executive Summary</b> .....	<b>ix</b>
Background.....	ix
Report Objectives Organization .....	ix
Conclusions.....	xi
<b>1. Introduction to the Decommissioning Methodology and Cost Evaluation Study</b> .....	<b>1-1</b>
<b>2. Review of Previous Decommissioning Studies</b> .....	<b>2-1</b>
2.1. Review of the 2009 GOM Study .....	2-1
2.2. Review of the 2010 POCS Study .....	2-2
<b>3. Structure and Asset Types</b> .....	<b>3-1</b>
3.1. Caissons .....	3-1
3.2. Compliant Towers (CT) .....	3-3
3.3. Fixed Platforms .....	3-4
3.4. Mobile Offshore Production Units (MOPU).....	3-5
3.5. Floating Production, Storage, and Offloading (FPSO) Vessels.....	3-5
3.6. Tension Leg Platforms (TLP) / Mini Tension Leg Platforms (MTLP).....	3-6
3.7. Semi-submersible Platforms (SEMI) .....	3-8
3.8. Spars .....	3-9
3.9. Well Protectors (WP) .....	3-10
3.10. Subsea Templates (SSTMP) .....	3-12
3.11. Distribution of Structure Types .....	3-13
<b>4. The Decommissioning Process</b> .....	<b>4-1</b>
4.1. Pre-job Activities.....	4-1
4.2. Well Plugging and Abandonment.....	4-3
4.3. Pipeline Decommissioning.....	4-5
4.4. Platform Decommissioning.....	4-5
4.5. Disposal.....	4-10
4.6. Site Clearance and Verification.....	4-11
4.7. Post-job Activities .....	4-11
<b>5. Facility Decommissioning Techniques and Methodology</b> .....	<b>5-1</b>
5.1. Well Plugging and Abandonment.....	5-1
5.2. Pipeline Decommissioning.....	5-10
5.3. Platform Decommissioning.....	5-15
5.4. Subsea Structure Decommissioning .....	5-21
5.5. Other Decommissioning Considerations .....	5-21
5.6. Site Clearance/Verification.....	5-24
<b>6. Decommissioning Technologies</b> .....	<b>6-1</b>
6.1. Well P&A.....	6-1
6.2. Well Intervention Vessels and Systems .....	6-7
6.3. Cutting and Severing.....	6-10
6.4. Heavy Lift Technologies .....	6-26
<b>7. Selecting Decommissioning Technologies</b> .....	<b>7-1</b>
7.1. Well Plugging and Abandonment.....	7-1

7.2. Pipeline Decommissioning.....	7-3
7.3. Umbilical Decommissioning.....	7-3
7.4. Platform Decommissioning.....	7-4
7.5. Subsea Structure Decommissioning .....	7-6
7.6. Decision Flowcharts.....	7-7
<b>8. Decommissioning Costs.....</b>	<b>8-1</b>
8.1. Introduction.....	8-1
8.2. Parameters Affecting Decommissioning Costs.....	8-2
8.3. Estimated Costs .....	8-9
8.4. Comparisons of Actual and Estimated Decommissioning Costs .....	8-40
<b>9. Contingencies and Uncertainties Impacting Cost Estimating .....</b>	<b>9-1</b>
9.1. Introduction.....	9-1
9.2. Contingencies .....	9-1
9.3. Uncertainties .....	9-5
<b>10. Non-technical Impacts on Decommissioning Costs .....</b>	<b>10-1</b>
10.1. Introduction.....	10-1
10.2. Inflation Impacts.....	10-1
10.3. Demand Impacts.....	10-3
10.4. Regional Impacts.....	10-4
10.5. Market Condition Impacts.....	10-7
10.6. Technology Impacts.....	10-8
10.7. Regulatory Impacts.....	10-9
10.8. Other Possible Impacts.....	10-9
<b>11. Safety and Environmental Accidents, Incidents and Events .....</b>	<b>11-1</b>
11.1. Introduction.....	11-1
11.2. Data Sources.....	11-1
11.3. Safety Incidents and Events.....	11-2
11.4. Environmental Incidents and Events .....	11-13
11.5. Risk Ranking.....	11-19
<b>12. Analysis of Decommissioning and Facility Removal Regulations .....</b>	<b>12-1</b>
12.1. United States .....	12-1
12.2. Other IRF Member Countries .....	12-7
12.3. Other Jurisdictions.....	12-9
12.4. Regulatory Matrix.....	12-10
12.5. Regulatory Gaps.....	12-27
12.6. Suggested Modifications .....	12-27

## List of Tables

Table 3-1. Existing Structures in the GOM .....	3-13
Table 6-1. Heavy Lift Vessels .....	6-27
Table 7-1. Well Plugging and Abandonment Techniques .....	7-1
Table 7-2. Pipeline Abandonment Techniques .....	7-3
Table 7-3. Umbilical Decommissioning Techniques.....	7-3
Table 7-4. Fixed Platform Decommissioning Techniques .....	7-4
Table 7-5. Floating Platform Decommissioning Techniques.....	7-5
Table 7-6. Subsea Structure Decommissioning Techniques .....	7-6
Table 8-2. Dry Tree Well T&A in WD 50' to 400' .....	8-12
Table 8-3. Well T&A Basic Parameters with Casing Jacks .....	8-14
Table 8-4. Dry Tree Well T&A in WD $\geq$ 400', 60 Wells per platform .....	8-15
Table 8-5. Pipeline Decommissioning Cost .....	8-22
Table 8-6. Umbilical Removal Costs .....	8-23
Table 8-7. Comparison of Explosive and Abrasive Severing Costs.....	8-25
Table 8-8. Estimated Decommissioning Costs of Representative Fixed Platforms.....	8-27
Table 8-9. Spar Platform Removal Preparation .....	8-31
Table 8-13. Spar Mooring Line Removal .....	8-33
Table 8-14. MTLP/TLP Removal Prep.....	8-33
Table 8-15. MTLP Deck <5000 st Deck Removal .....	8-34
Table 8-16. MTLP Deck >5000 st Deck Removal .....	8-34
Table 8-17. MTLP Tendon & Hull Disconnect and Removal.....	8-34
Table 8-18. TLP Tendon & Hull Disconnect and Removal .....	8-35
Table 8-19. SEMI Platform Removal .....	8-36
Table 8-20. SEMI Mooring Line Removal .....	8-37
Table 8-21. Shelley FPSO Decommissioning Costs.....	8-38
Table 8-22. Site Clearance and Verification Costs .....	8-39
Table 8-23. Decommissioning Component Costs .....	8-39
Table 8-24. Fixed Platforms with Actual and Estimated Removal Costs with Pile Information .....	8-42
Table 10-1. Estimated Derrick Barge Mob/Demob Costs, Pacific OCS .....	10-5
Table 10-2. Estimated Derrick Barge Mob/Demob Costs, GOM OCS .....	10-6
Table 10-3. Decommissioning Approaches around the World .....	10-6
Table 11-1. Number of U.S. Decommissioning Related Safety Incidents with Fatalities and Injuries by Equipment Type, 2004-2014' .....	11-3
Table 11-2. Number of U.S. Decommissioning Related Safety Incidents by Incident Type and Equipment Type, 2004-2014' .....	11-4
Table 11-3. Number of U.S. Decommissioning Related Safety Incidents with Fatalities and Injuries by Cause, 2004-2014' .....	11-5
Table 11-4. Number of U.S. Decommissioning Related Safety Incidents by Cause, 2004-2014.....	11-6
Table 11-5. Worldwide Reportable Incidents by Operation, 2010-2013.....	11-9
Table 11-6. Number of U.S. Spill Incidents by Equipment Type and Spill Material, 2004-2014.....	11-14
Table 11-7. Number of U.S. Spill Incidents by Cause, 2004-2014.....	11-14
Table 12-1. State Comparison Regulatory Matrix.....	12-11
Table 12-2. International Comparison Regulatory Matrix .....	12-18

## List of Figures

Figure 3-1. Typical Caisson Platforms .....	3-2
Figure 3-2. Typical Caisson Platform Components .....	3-2
Figure 3-3. Compliant Towers .....	3-3
Figure 3-4. Typical Fixed Platform.....	3-5
Figure 3-5. Typical FPSO.....	3-6
Figure 3-6. Representative FPSO's .....	3-6
Figure 3-7. Typical TLP (MC-807-A).....	3-7
Figure 3-8. Representative TLP's.....	3-8
Figure 3-9. Representative Semi-submersible Platforms .....	3-9
Figure 3-10. Typical Semi-submersible .....	3-9
Figure 3-11. Representative Spars .....	3-10
Figure 3-12. Typical Spar (MC-773-A) .....	3-10
Figure 3-13. Tripod Well Protector .....	3-11
Figure 3-14. 4-Pile Well Protector.....	3-11
Figure 3-15. Typical Subsea Template Layout.....	3-12
Figure 3-16. History of Platform Installation in the GOM.....	3-14
Figure 4-1. Deck Ready to Be Installed .....	4-7
Figure 4-2. Deck Installed.....	4-8
Figure 5-5. Bubbling Well After Abandonment .....	5-9
Figure 5-6. Flexlife UT Riser Scanner.....	5-15
Figure 5-7. Deck Severed into Lift Sections.....	5-17
Figure 5-8. Setting Deck for Seafastening.....	5-17
Figure 5-9. Typical Hurricane Katrina Damage, 2005 .....	5-22
Figure 5-10. Hurricane Katrina Damage, 2005.....	5-22
Figure 5-11. Hurricane Ike Damaged Platform, 2008 .....	5-23
Figure 5-12. Damaged Vermilion 281-A Platform, 2008.....	5-23
Figure 5-13. Site Clearance and Verification Trawling Patterns .....	5-25
Figure 5-14 Example Scrap Pile from Site Clearance .....	5-26
Figure 6-7. Snubbing Unit .....	6-5
Figure 6-8. Hydraulic Workover Unit .....	6-6
Figure 6-9. Coil Tubing Unit.....	6-7
Figure 6-10. Q4000 Well Intervention Vessel .....	6-8
Figure 6-11. Oceaneering Well Intervention Vessel .....	6-9
Figure 6-12. Expro Group AX-S Subsea Well Intervention System .....	6-10
Figure 6-13. Template removal by explosives .....	6-11
Figure 6-14. Bulk Charges .....	6-12
Figure 6-15. Shaped Charges .....	6-14
Figure 6-16. Linear Charge .....	6-15
Figure 6-17. Diamond Wire Cutting System.....	6-17
Figure 6-18. ROV Diamond Wire Tool.....	6-19
Figure 6-19. Guillotine Saw .....	6-20
Figure 6-20. Water abrasive Cutting c/w internal manipulators .....	6-21
Figure 6-21. Water Abrasive Cutting.....	6-21
Figure 6-22. Hydraulic Mechanical Shear .....	6-22

Figure 6-23. Pipeline Cut with Power Shear .....	6-23
Figure 6-24. Multi-string Conductor Sheared below the Mudline.....	6-23
Figure 6-25. Power Shear Cutting Platform Jacket .....	6-24
Figure 6-26. Power Shear Cutting Platform Deck Beam .....	6-24
Figure 6-27. Mechanical Cutting Tool .....	6-25
Figure 6-28. Grouted Caisson Severed with Tungsten Beaded Wire.....	6-25
Figure 6-29. Siapem 7000 and Heerema Thialf Semi-Submersible Crane Vessels .....	6-28
Figure 6-30. Heerema H-851 Cargo Barge .....	6-28
Figure 6-31. Versatruss Jacket Lifting System Topside/Jacket Lifting.....	6-29
Figure 6-32. Versabar VB 4000 Bottom Feeder Lifting System.....	6-30
Figure 6-33. Versabar VB 10,000 .....	6-31
Figure 6-34. Versabar Claw Controlled by VB 10,000 Lift System .....	6-32
Figure 6-35. Allseas Pioneering Spirit Lifting System Topsides/Jacket .....	6-33
Figure 6-36. Control Variable Buoyancy System (CVBS) .....	6-34
Figure 6-37. Frigg DP2 Platform Removal .....	6-36
Figure 6-38. Buoyancy Tank Assembly.....	6-37
Figure 6-39. Seametric International Twin Marine Lifter .....	6-38
Figure 8-1. Southern Scrap Yard Morgan City.....	8-7
Figure 8-2. Southern Scrap Yard .....	8-7
Figure 8-3. Gulf Marine Fabricators Yard.....	8-8
Figure 8-4. Gulf Marine Fabricators .....	8-9
Figure 8-5. Total Well Costs .....	8-13
Figure 8-6. Per Well Costs .....	8-13
Figure 8-7. T&A Cost per Well as a Function of WD and Number of Wells .....	8-16
Figure 8-8. T&A Cost per Foot of Well as a Function of WD and Number of Wells.....	8-16
Figure 8-9. Subsea Well P&A Durations (mob/demob not included).....	8-19
Figure 8-10. Subsea Well P&A Costs by Depth (mob/demob not included) .....	8-20
Figure 8-11. Umbilical Removal Costs.....	8-24
Figure 8-12. Total Cost per Conductor for Removal Using Abrasive Severing and Casing Jacks .....	8-26
Figure 8-13. Estimated Platform Decommissioning Costs .....	8-28
Figure 8-14. Platform Removal Costs, Single Lift .....	8-29
Figure 8-15. Platform Removal Costs, Tow to Shallow .....	8-29
Figure 8-16. Platform Removal Costs, Jacket Sectioning .....	8-30
Figure 8-17. Estimated Platform Removal Costs w/o Conductor Costs.....	8-30
Figure 8-18. Actual and Estimated Platform Removal Costs .....	8-45
Figure 8-19. Actual vs. Estimated Platform Removal Costs .....	8-46
Figure 8-20. Actual Minus Estimated Platform Removal Costs .....	8-47
Figure 10-1. Offshore Vessel Prices Normalized to 1996.....	10-1
Figure 10-2. U.S. General Construction Inflation - Normalized to Dec-2003 Values .....	10-2
Figure 10-3. Heavy Construction Inflation from 2003 to 2014 - Normalized to Dec-2003.....	10-3
Figure 10-4. Platform Installations and Removals after Major Storms .....	10-4
Figure 11-1. Average Severity of U.S. Decommissioning Related Injury/Fatality by Operation and Equipment Type, 2004-2014.....	11-7
Figure 11-2. Average Severity of U.S. Decommissioning Related Injury/Fatality by Cause, 2004- 2014 .....	11-8
Figure 11-3. Worldwide Fatalities and Lost Work Day Cases (LWDCs) by Operation, 2010-2012 .....	11-12
Figure 11-4. Worldwide Fatalities and LWDCs by Category, 2010-2012 .....	11-13

Figure 11-5. Average Severity of U.S. Spills by Operation or Equipment Type, 2004-2014 ..... 11-15

Figure 11-6. Total Spill Volume of U.S. Spills by Operation or Equipment Type, 2004-2014 ..... 11-16

Figure 11-7. Average Severity of U.S. Decommissioning Spills by Cause, 2004-2014 ..... 11-17

Figure 11-8. Total Spill Volume of U.S. Decommissioning Spills by Cause, 2004-2014 ..... 11-18

Figure 11-9. Worldwide Number of Spills >100 bbl in Size and Volume Lost from Primary  
Containment, 2010-2012 ..... 11-19

Figure 11-10. Worldwide Number of Spills 10-100 bbl in Size and Volume Lost from Primary  
Containment, 2010-2012 ..... 11-19



## Executive Summary

### Background

The mission of the Bureau of Safety and Environmental Enforcement (BSEE) is to promote safety, protect the environment, and conserve resources offshore through regulatory oversight and enforcement. Through its Technology Assessment Programs (TAP), BSEE supports research related to operational safety and pollution prevention to provide engineering support to BSEE decision makers, to promote the use of Best Available and Safest Technologies (BAST), and to coordinate international research. The objectives of this study, Decommissioning Methodology and Cost Evaluation, address each of these research areas.

Specifically, the study results will improve BSEE's ability to determine the proper amount of supplemental bonding required to ensure compliance with decommissioning requirements, will improve BSEE's knowledge of current decommissioning methods and equipment capabilities, and documents the safety and environmental performance of decommissioning and facility removal operations. This technical report was prepared for the Bureau of Safety and Environmental Enforcement (BSEE) to research and document conventional domestic and global offshore decommissioning techniques, the estimated and actual costs of those techniques, and the regulatory structures that govern decommissioning and facility removal projects around the world.

ICF International, Inc. (ICF) together with TSB Offshore, Inc. (TSB) prepared this report with input from BSEE. ICF provides professional services and technology solutions that deliver beneficial impact in areas critical to the world's future, producing compelling results throughout the entire program lifecycle, from research and analysis through implementation and improvement. TSB is widely recognized as the oil and gas industry leader in providing worldwide offshore abandonment consulting services that include project planning, abandonment liability estimates and asset retirement obligations, detailed project studies, project management, and permitting support.

### Report Objectives Organization

This report provides detailed information on the methodology, techniques, engineering considerations, and costs associated with decommissioning offshore assets. The report includes all aspects of the decommissioning process from including planning, well abandonment, pipeline decommissioning, platform decommissioning, disposal, and site clearance. Cost estimates are presented for individual aspects of representative facilities and components. The study compares estimated decommissioning costs to actual costs and discusses the variances and their causes. Conclusions and recommendations for improving the quality of decommissioning cost estimates are also provided. Decommissioning safety performance, environmental performance, and regulations are compared for jurisdictions with offshore oil production around the world.

This report is composed of the following chapters:

Chapter 1 introduces the study and describes its component tasks. Chapter 2 summarizes the reviews of previous Gulf of Mexico OCS and Pacific OCS decommissioning cost studies.

Chapter 3 provides a catalog of offshore oil and gas structures and asset types so that the reader understands the types of structures to be decommissioned.

Chapter 4 provides an overview of the major steps in a decommissioning project, whereas Chapter 5 presents a much more detailed and technically rich explanation of each step.

Chapter 6 describes the technologies, i.e. the equipment and tools, used in offshore decommissioning and Chapter 7 discusses the selection of the appropriate technology for different tasks under various conditions.

Chapter 8 discusses the cost estimation process, presents cost data and curves for the major decommissioning steps, and summarizes how to build a decommissioning cost estimate. Chapter 8 also presents estimated and actual decommissioning costs for over 200 structures and discusses the variance between the estimated and actual costs.

Chapter 9 discusses various components that go into a decommissioning cost estimate but that may be harder to quantify than the physical aspects of removal. These include foreseeable costs due to engineering, project management, weather delays, and deviations from the planned scope of work. It also discusses other events or conditions with a much lower probability of occurrence but which can cause work delays or additional costs.

Chapter 10 examines a number of non-technical factors that can affect cost estimates for decommissioning planned for future implementation. Assumptions regarding these factors, such as inflation, labor market conditions, equipment availability, technological developments, or regulatory constraints, should be stated in the estimate so that the costs can be adjusted if the future conditions deviate from the assumptions.

Chapter 11 analyzes the history of safety and environmental incidents that have occurred during offshore decommissioning in the U.S. Because little decommissioning has been done outside of the Gulf of Mexico, the analysis of global safety and environmental performance relies on statistics for all offshore oil and gas activities.

Chapter 12 looks at the statutes and regulations that govern offshore decommissioning in U.S. federal waters, in state waters, and in countries around the world. The chapter discusses potential gaps in U.S. regulations and recommends some potential improvements.

## Conclusions

The decommissioning of offshore oil and gas facilities presents many challenges throughout all parts of the operation. Development of new and innovative structures to explore and produce in deeper waters has been followed by continued development of new methods and techniques to remove those facilities when they reach the end of their productive lives. The historical performance of decommissioning projects provides useful guidance in developing cost estimates for future projects. The uncertainties of offshore work mean that cost estimates will never be perfect due to ocean and weather conditions beyond the operator's control, but a structured approach to cost estimation and periodic benchmarking against actual projects affords the best approach for operators and for BSEE to determine reasonable decommissioning cost estimates.

## Acronyms, Abbreviations, and Definitions

Acronym / Abbreviation	Stands For
AHSV	Anchor Handling Support Vessel
AHT	Anchor Handling Tug
ANP	Agência Nacional do Petróleo, Gás Natural e Biocombustíveis (Brazilian National Petroleum Agency)
ARO	Asset Retirement Obligation
AWJ	Abrasive Water Jet
BAST	Best Available and Safest Technology
BOEM	Bureau of Ocean Energy Management
BML or bml	Below Mud Line
BOEMRE	Bureau of Ocean Energy Management, Regulation and Enforcement
BOP	Blowout Preventer
BOPE	Blowout Prevention Equipment
BSEE	Bureau of Safety and Environmental Enforcement
BTA	Buoyancy Tank Assembly
CB	Cargo Barge
CFR	Code of Federal Regulations
CIBP	Cast Iron Bridge Plug
C-NLOPB	Canada-Newfoundland and Labrador Offshore Petroleum Board
CNSOPB	Canada-Nova Scotia Offshore Petroleum Board
COG	Center of Gravity
CT	Compliant Tower
CVBS	Controlled Variable Buoyancy System
DB	Derrick Barge
DDCV	Deep Draft Caisson Vessel
DEA	Danish Energy Agency
DOI	Department of the Interior
Downhole	Refers to well formations, as in pumping flushed fluids downhole or into the well and its formations
DP	Dynamically Positioned
Dry Tree	A well with its wellhead located above the water surface
DSI	Deep Sea Intervention vessel
DSV	Dive Support Vessel

Acronym / Abbreviation	Stands For
DWCS	Diamond Wire Cutting System
E&PM	Engineering & Project Management
EBW	Exploding Bridge Wire
EIS/EIR	Environmental Impact Statement/Environmental Impact Report
FPSO	Floating Production Storage and Offloading Vessel
GOM	Gulf of Mexico
HLV	Heavy Lift Vessel
Hopping	A HLV lifts the jacket partially out of water, secures it to the vessel, transports it to a shallower water depth, sets the jacket on the bottom and severs and removes the above the waterline section. The process is repeated until the jacket is completely removed.
HSE	Health and Safety Executive, United Kingdom
IBU	Intelligent Buoyancy Unit
IRM	Inspection, Repair, and Maintenance
IRF	International Regulator Forum
LB	Lift Boat – numerical value after LB refers to the working depth in feet (LB 100)
Methodology	The method of decommissioning, as in the overall process; e.g., completely remove the jacket. Also called process
Mob/Demob	Mobilization/Demobilization
MODU	Mobile Offshore Drilling Unit
MOPU	Mobile Offshore Production Unit
MSV	Multi-Service Vessel
MSV-T	Multi-Service Vessel with Tower
MTLP	Mini Tension Leg Platform
NEPA	National Environmental Policy Act
NM	Nautical Mile (approx. 6,076 feet or 1.15 miles)
NOPSEMA	National Offshore Petroleum Safety and Environmental Management Authority, Australia
NTL	Notice to Lessees and Operators
OCS	Outer Continental Shelf
P&A	Plug and Abandon
PAES®	Platform Abandonment Estimating System
PEA	Programmatic Environmental Assessment
PEIS	Programmatic Environmental Impact Statement

Acronym / Abbreviation	Stands For
Piece small	Piece small is a decommissioning methodology to remove structures by cutting into pieces small enough to fit into regular waste containers, and are shipped to shore by standard supply vessels.
PL	Pipeline
PLET	Pipeline End Termination
PM	Project Management
POCS	Pacific Outer Continental Shelf
POOH	Pull Out Of Hole
Process	The overall decommissioning methodology
ROV	Remotely Operated Vehicle
SAT	Saturation Diving
SCSSV	Surface Controlled Subsurface Safety Valve
SEMI	Semi-submersible Platform
SILS®	Subsea Intervention Lubricator System
Spread	The particular assemblage of crew and equipment required to complete a particular task
SSCV	Semi-submersible Crane Vessel
SSM	State Supervision of Mines, The Netherlands
SSS	Side-Scan Sonar
SSTI	Subsea Tie-In (where a pipeline ties in or attaches to another pipeline as in a perpendicular or angled connection)
SSTMP	Subsea Template
st	Short Ton Unit
SUTA	Subsea Umbilical Termination Assembly
SWED	Shock Wave Enhancement Device
TAP	Technology Assessment Programs
Technique	The techniques used to accomplish the overall decommissioning methodology or process; e.g., remove the jacket by cutting into smaller pieces under water
Technology	The resources used to perform the decommissioning technique; e.g., cutting the jacket underwater using divers or ROV with either diamond wire cutters, shears, etc.
TLP	Tension Leg Platform
TSB	TSB Offshore, Inc.
UTA	Umbilical Termination Assembly
WD	Water Depth in feet
Wet Tree	A well with its wellhead located below the water surface

<b>Acronym / Abbreviation</b>	<b>Stands For</b>
WIV	Well Intervention Vessel
WOC	Wait on cement
WP	Well Protector

## Acknowledgments

ICF would like to recognize the governmental agencies and commercial firms that contributed information for this report.

The International Regulators' Forum (IRF) is a consortium of regulatory bodies that oversee health and safety issues in the offshore upstream oil and gas industry. As part of this study, ICF reached out to all of the IRF member agencies for their input on technical, financial, environmental, safety, and regulatory issues associated with decommissioning offshore structures. In particular, we would like to thank the following individuals for their contributions:

- Jeremy Dunster, National Offshore Petroleum Safety and Environmental Management Authority (NOPSEMA), Australia
- Luciano da Silva Pinto Teixeira, Brazilian National Petroleum Agency (ANP), Brazil
- Daniel Chicoyne, Canada-Newfoundland and Labrador Offshore Petroleum Board, (C-NLOPB), Canada
- Richard Loughery, Canada-Nova Scotia Offshore Petroleum Board, (CNSOPB), Canada
- Hans Christian Langager, Danish Energy Agency (DEA), Denmark
- Ivan Abdoellakhan, State Supervision of Mines (SSM), The Netherlands
- Wayne Vernon, Department of Labour Workplace Services, New Zealand
- Reidar Hamre, Petroleum Safety Authority Norway, Norway
- Stewart Millar, The Health and Safety Executive (HSE), United Kingdom

As part of this study, we initiated outreach efforts to companies involved in decommissioning activities to request that they share confidential information on techniques and costs. The confidentiality agreements with the firms that contributed data preclude mentioning them by name, but the comparisons between estimated and actual cost data would not have been possible without their input. We thank them for their kind participation in this study.

ICF's subcontractor, TSB Offshore, Inc., provided the bulk of the information on the technical aspects of offshore decommissioning, generated the estimated decommissioning costs that made the estimated vs. actual cost comparisons possible, and prepared large sections of this report.

Finally, we would like to thank the members of the BSEE project team that contributed to this study, especially the Contracting Officer Herma Banks, the Contracting Officer's Representative and Project Manager Mohammad Ashfaq, and Subject Matter Experts and Reviewers Olivia Adrian, Keith Good, Peter Hosch, Kathy Hoffman, and Joseph Levine. Their comments and reviews of the report during its production added valuable insights from the regulator's perspective, clarified technical details, and greatly improved the final result.



# **1. Introduction to the Decommissioning Methodology and Cost Evaluation Study**

The mission of the Bureau of Safety and Environmental Enforcement (BSEE) is to promote safety, protect the environment, and conserve resources offshore through regulatory oversight and enforcement. Through its Technology Assessment Programs (TAP), BSEE supports research related to operational safety and pollution prevention to provide engineering support to BSEE decision makers, to promote the use of Best Available and Safest Technologies (BAST), and to coordinate international research. The objectives of this study, Decommissioning Methodology and Cost Evaluation, address each of these research areas. This study has been prepared under BPA No. E13PA00010, Call Order No. E14PB00056.

This report documents conventional domestic and global decommissioning and facility removal techniques, the estimated and actual costs of those techniques, and the regulatory structures that govern decommissioning and facility removal around the world. The study will improve BSEE's ability to determine the proper amount of supplemental bonding required to ensure compliance with decommissioning requirements, will improve BSEE's knowledge of current decommissioning methods and equipment capabilities, and will document the safety and environmental performance of different equipment and methods used globally during decommissioning and facility removal operations.

The technical approach framed the scope of work into eight tasks. Task 1 involved the review of previous MMS decommissioning reports. Tasks 2, 3, and 4 involved the collection of data and the analysis of activities related to estimated and actual costs, decommissioning methodologies and facility removal techniques, safety incidents, and environmental incidents. Tasks 5, 6, and 7 involved documenting the decommissioning decision process, cost estimation uncertainties and contingencies, and non-technical cost factors. Task 8 evaluated BSEE regulations in comparison to other jurisdictions.

## 2. Review of Previous Decommissioning Studies

BSEE (and its predecessor MMS) perform periodic studies and publish reports describing the technologies, methodologies, and costs associated with decommissioning offshore facilities. The intent of BSEE is to update these reports every five years to incorporate new information that may result from advances in technology, changes in market conditions, or new regulatory requirements. This section summarizes the results of the reviews of the most recent previous reports for decommissioning in the Gulf of Mexico and in the Pacific OCS region and identifies key aspects that have been improved in this report.

### 2.1. Review of the 2009 GOM Study

The 2009 report “Gulf of Mexico Deep Water Decommissioning Study, Review of the State of the Art for Removal of GOM US OCS Oil & Gas Facilities In Greater Than 400’ Water Depth”<sup>1</sup> presented an overall review of decommissioning approaches and costs. The report provided a solid background on the variety and complexity of offshore decommissioning and the technology and methodology available. The cost sections allowed the reader to piece together various costs and get an understanding or a general estimate of the total cost for a particular type of structure with various specifics; e.g., the estimated cost for a 4-pile platform in a particular water depth with a described number of wells and with a specified number of pipelines.

The 2009 study focused only on GOM decommissioning techniques, whereas this study considered other global and regional technologies and methodologies. This report also incorporates information on any decommissioning methodologies, technologies and equipment in use since 2009. For example, ever larger platforms, such as those in the Gulf of Thailand region where the jackets were installed by launching off of a transport barge and where the decks were installed using a float-over method, will require removal methods other than traditional derrick barge removal. This report also covers more recently developed technologies such as the use of gel pigs, increased industry use of remotely operated vehicles (ROVs), and advances in cold cutting methods and mechanical shearing.

The costs for various aspects of decommissioning were provided in separate sections in the 2009 report. Although the report did allow the reader to understand the steps in the decommissioning process and to understand the costs of each step, it was not designed to develop a total decommissioning cost for the purpose of bonding estimates. The previous study did not provide a visual or descriptive path on how to go about selecting the correct decommissioning method and associated resources nor did it provide an example of how to use the report to derive a total cost for a particular facility. This report includes a newly-developed matrix to guide the reader in the decision process of what methodologies to consider and where to go in the report to find appropriate information and costs for those methodologies. It also includes guidelines on the appropriate use and limitations of the cost data and cost formulas. The

---

<sup>1</sup> Proserv Offshore (2009), “Gulf of Mexico Deep Water Decommissioning Study, Review of the State of the Art for Removal of GOM US OCS Oil & Gas Facilities In Greater Than 400’ Water Depth”, Final Report, MMS M09PC00004, Houston, TX.

discussion of costs includes new or expanded material on dry tree platform wells, umbilical abandonment, subsea structure decommissioning, and the uncertainties and contingencies associated with decommissioning.

## 2.2. Review of the 2010 POCS Study

### 2.2.1. Overview

The 2010 report “Decommissioning Cost Update for Removing Pacific OCS Region Offshore Oil and Gas Facilities, January 2010”<sup>2</sup> presented a review of the decommissioning practices for the Pacific OCS region oil and gas facilities and developed benchmark costs for decommissioning the facilities utilizing conventional technology. The report included cost assessments specific to the Pacific Region operations and included reviews of the availability and capability of derrick barges; support vessel services; well plugging and abandonment services; abrasive, mechanical and explosive cutting services; disposal options; and site clearance services available along the west coast of the U.S.

The Pacific OCS decommissioning cost report was updated in 2014<sup>3</sup>. No decommissioning work has been performed in the Pacific OCS region so, except for updates on the estimated costs, the structure and content of the 2014 report is similar to its 2010 predecessor. Where relevant, the updated cost information from the 2014 Pacific OCS report is used in this report.

### 2.2.2. Undeveloped Market

The 2010 report documented that no structures had been decommissioned in the Pacific OCS region and that only 7 relatively small structures had been decommissioned in California state waters, with the last decommissioning occurring in 1996. No additional structures have been decommissioned since 2010. The future market for decommissioning is also small because there are only 23 platforms in the region. Therefore, offshore decommissioning equipment is not normally available along the U.S. Pacific coast.

The market has limited access to standard offshore oilfield equipment and spreads, i.e. the particular assemblage of crew and equipment required to complete a particular task. Local companies could be utilized, but there would be a lack of synergy and experience in decommissioning. Well P&A spreads exist in the California onshore region, but they are not easily converted to offshore operations as they are truck mounted or diesel powered. The well P&A spreads would most likely be mobilized from the GOM. These spreads will have the proper equipment and experience for these operations, but they may lack equipment modifications required to meet the more stringent California emission requirements.

---

<sup>2</sup> Proserv Offshore (2010), “Decommissioning Cost Update for Removing Pacific OCS Region Offshore Oil and Gas Facilities, January 2010”, Volumes 1 and 2, MMS M09PC00024, Houston, TX.

<sup>3</sup> TSB Offshore, Inc. (2014), “Decommissioning Cost Update for Pacific OCS Region Facilities”, Volumes 1 and 2, Houston, TX.

Many standard decommissioning methodologies require the use of large derrick barges which may be unavailable in or expensive to mobilize to the Pacific OCS region. Decommissioning operations on a majority of the platforms will require the use of a dynamic positioning (DP) vessel which is not currently available in the Pacific region and would have to be mobilized. Alternative methods and techniques may be adopted for some platforms to cost effective decommissioning project.

Diving operations are performed frequently on the Pacific coast but these operations do not normally include decommissioning operations. The majority of these diving operations involve standard platform or pipeline work that occurs in shallow water.

### **2.2.3. Availability of Cost Data**

The lack of recent decommissioning projects in the Pacific OCS region makes the acquisition of actual decommissioning cost data difficult and requires more indirect methods to estimate costs. Local companies are willing to discuss the costs of mobilizing equipment and personnel for operations, however, advance mobilization costs are of limited use as mobilization costs can vary greatly due to market influences and can change significantly over a short period of time.

The use of local service providers needs to be compared with the advantages of mobilizing crews and equipment from the GOM. Mobilizing well P&A equipment and workforce from GOM is relatively inexpensive compared to the total expected service cost for a single platform. Mobilizing a DB from GOM or Asia is a significant cost component of the overall decommissioning process. For some of the deeper platforms, this could be offset against the increased time on station in using a smaller DB in combination with deep reach vessel approach (see 2014 Pacific OCS study). The 2014 Pacific OCS study incorporated local resources rates for diving services, trawling services, and material disposal sites whereas the remaining equipment and services not locally available were estimated as if they were being mobilized from outside California.

The 2014 study verifies or updates the information on derrick barge availability, the current well numbers and classifications, the pipeline and power cable inventories, conductor sizes and weights, and recycling facility capabilities.

All costs in the 2014 report were updated to current market values or adjusted for past inflation rates.

## 3. Structure and Asset Types

The purpose of this section is to identify and categorize the various configurations of platforms. The types of platforms that are classified in the BSEE database are listed below. This section provides descriptions of each type of platform.

- Caissons
- Compliant Towers
- Fixed Platforms
- Floating Production, Storage, and Offloading (FPSO) vessels
- Mobile Offshore Production Units (MOPU)
- Mini Tension Leg Platforms (MTLP) / Tension Leg Platforms (TLP)
- Semi-submersible Platforms (SEMI)
- Spars
- Well Protectors (WP)
- Subsea Templates (SSTMP)

### 3.1. Caissons

Caissons are straight cylindrical or tapered steel pipes driven into the seabed that support a steel deck above the waterline. The caisson can be the well conductor or one or more conductor(s) can be installed inside or outside the caisson. The wellhead inside the conductor is typically connected by a pipeline to a nearby production platform. Outside diameters can range from 30” for a shallow water straight caisson or 96”-120” for tapered multi-well caissons in deeper water. The term “tapered” here is used to describe a caisson that has a larger diameter in the lower portion than the upper section. The transition or taper can be above or below the waterline. The caisson can be free-standing or supported by a cable mooring system secured to piles driven into the seabed or supported with one or more piles driven at an angle into the seabed and secured to the caisson, the later often called a braced caisson. BSEE files lists total weights of (decommissioned) caisson structures from 30 to 544 tons including conductors and from 25 to 502 without conductors. Typical deck dimensions can vary from 10’X10’ to 40’X45’. According to BSEE database, the deepest caisson in the GOM is located in 173’ of water. Typical caissons are illustrated in Figure 3-1 and Figure 3-2.

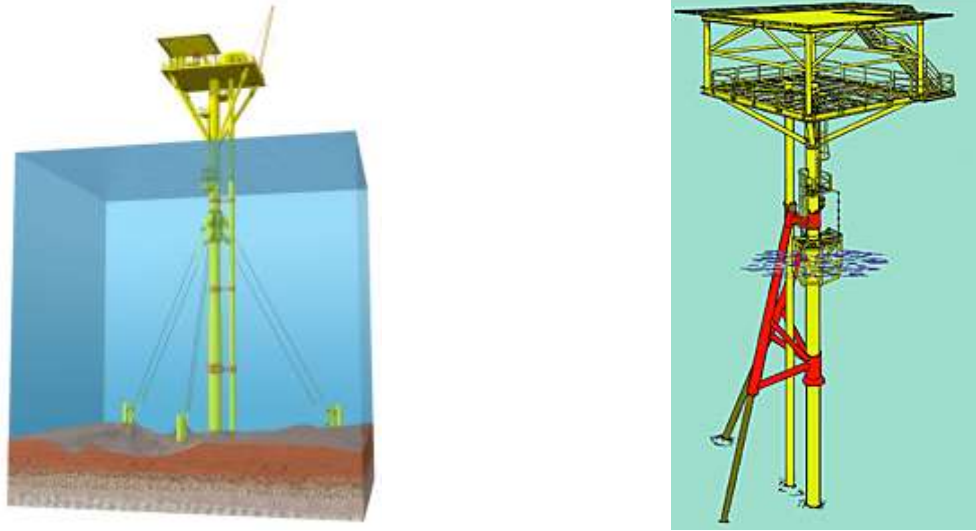

Figure 3-1. Typical Caisson Platforms

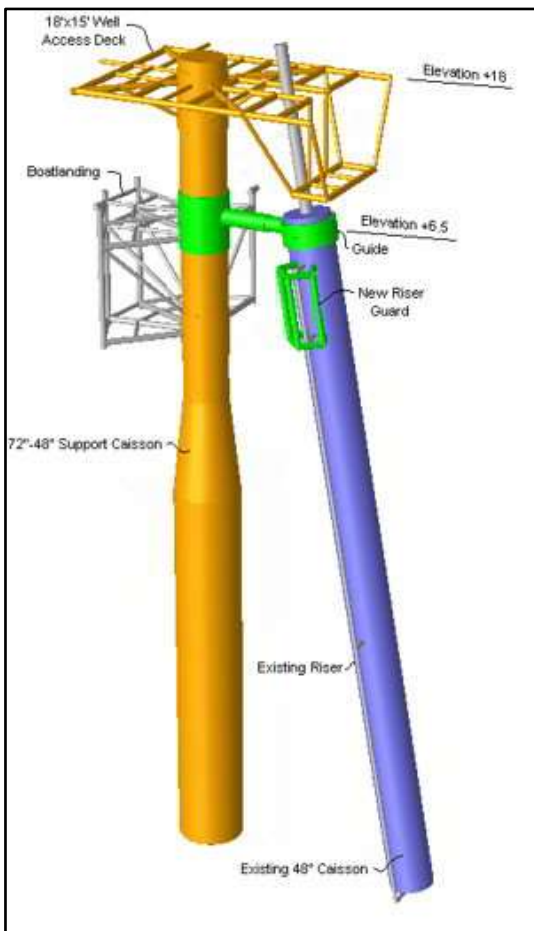

Figure 3-2. Typical Caisson Platform Components

### 3.2. Compliant Towers (CT)

A compliant tower (CT) is a fixed rig steel structure normally used for the offshore production of oil or gas. The rig consists of narrow, flexible (compliant) steel lattice towers and a piled foundation supporting a conventional deck for drilling and production operations. Compliant towers are designed to sustain significant lateral deflections and forces, and are typically used in water depths ranging from 1,500 to 3,000 feet (450 to 900 m). According to the BSEE database the deepest CT in the GOM is located in 1,754' of water at VK-786-A, also known as Petronius. With the use of flex elements such as flex legs or axial tubes, resonance is reduced and wave forces are de-amplified. This type of rig structure can be configured to adapt to existing fabrication and installation equipment. Compared with floating systems, such as tension-leg platforms and SPARs, the production risers are conventional and are subjected to less structural demands and flexing. [1] However, because of cost, it becomes uneconomical to build compliant towers in depths greater than 1,000 meters. In such a case a floating production system is more appropriate, even with the increased cost of risers and mooring. Despite its flexibility, the compliant tower system is strong enough to withstand hurricane conditions.

The first tower emerged in the early 1980s with the installation of Exxon's Lena oil platform. (Wikipedia) Typical compliant towers are illustrated below in Figure 3-3.

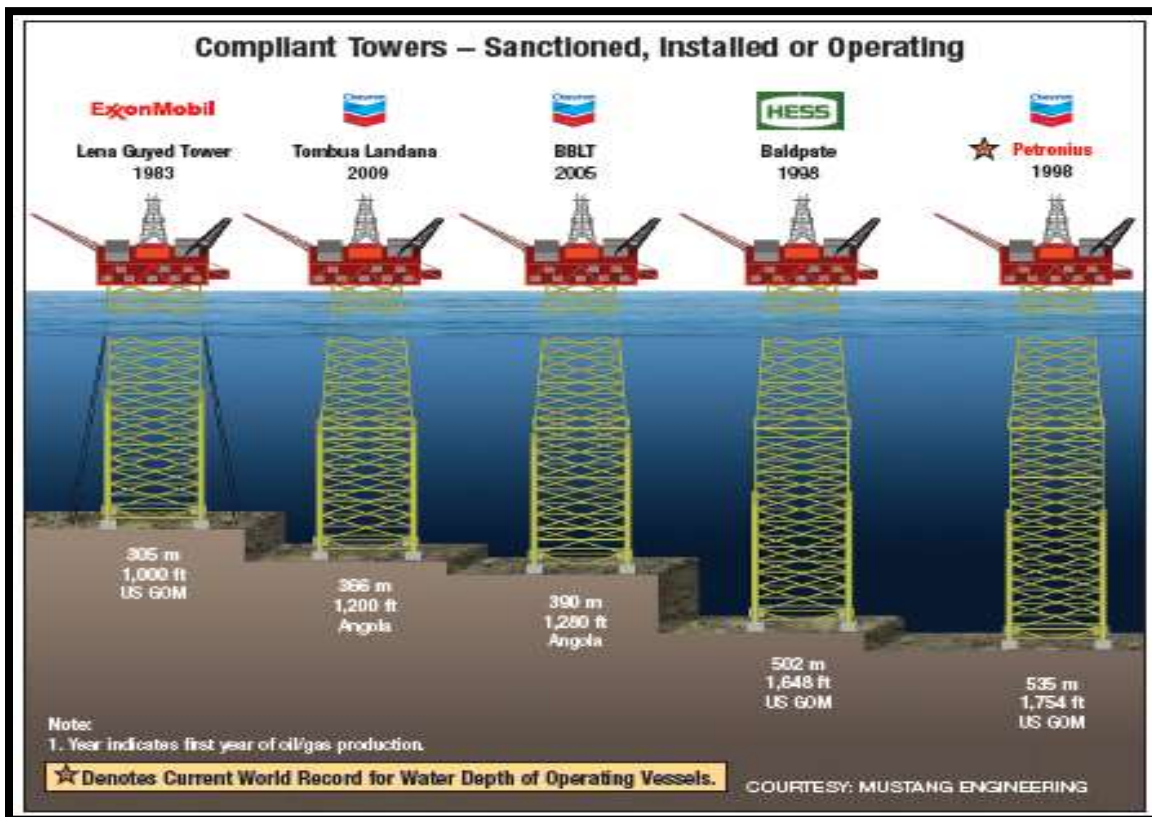

Figure 3-3. Compliant Towers

### 3.3. Fixed Platforms

Fixed platforms are built on concrete or steel legs, or both, anchored directly onto the seabed, and support a deck with space for drilling rigs, production facilities and crew quarters. These platforms are designed for long term use due to their immobility. Steel jackets are vertical sections made of tubular steel members and are usually piled into the seabed. These platforms typically have 3 to 12 legs, sometimes more, and are anchored to the seabed with piles driven through the legs or through external skirt pile guides, as shown in Figure 3-4. The platforms usually include several decks - wellhead deck, production deck, sump deck, main deck and a helideck. The platforms are used when there will be production from wells. Wells may be centered on the platform or grouped to one side of the platform to facilitate the use of a jackup rig or a drilling rig. The platforms typically contain 4 to 24, but sometimes more, slots or openings where the wells may be drilled or conductors may be placed. The smaller fixed platforms located in shallower waters are not designed to support the weight of a drilling or workover rig, however the larger fixed platforms located in deeper waters are designed to support a drilling rig capable of drilling to over 20,000'. For two-legged platforms in water depths from 12 to 60 ft, jacket weights range from 10 to 5,000 tons and deck weights range from 30 to 50 tons. For eight-legged platforms in water depths from 50 to 935 ft, jacket weights range from 227 to 20,400 tons and deck weights range from 200 to 17,000 tons. Typical deck sizes range from 50' x 50' in shallow waters up to 75' x 120' in deep waters<sup>4</sup>. According to the BSEE database the deepest fixed platform in the GOM is located in 1,353' of water at GC-65-A, also known as Bullwinkle. The deepest fixed platform in the in the Pacific OCS region is Exxon's Harmony platform located in 1,198' of water.

---

<sup>4</sup> There is no offshore industry standard for deep water. The delineation depth varies by region and changes over time as projects are developed in ever deeper waters. In the North Sea in the 1970s and 1980s, deep water would have been anything deeper than 100 ft to 700 ft. In 2008, MMS stated that the boundary between shallow water and deepwater can range from 656 ft to 1,500 ft and selected a delineation depth of 1,000 ft. We have not attempted to establish a definition of the boundary between shallow water and deep water and the term should be interpreted qualitatively throughout this report.





**Figure 3-4. Typical Fixed Platform**

### **3.4. Mobile Offshore Production Units (MOPU)**

A Mobile Offshore Production Unit (MOPU) is a movable structure that serves as a platform for well and production operations. Although the floating platforms described below (FPSOs, TLPs, SEMIs, and Spars) are sometimes considered MOPUs, this section is limited to the most common usage which pertains to a static MOPU, typically a jack-up drilling rig. MOPUs have evolved from mobile drilling platforms to become complete production facilities. They are often considered for marginal fields because of their lower installation and removal costs.

A typical MOPU consists of a floating hull or platform with a large, flat deck area through which multiple, extendable legs can be lowered to or into the seabed to lift the platform above the water level. Foundation preparation to support the legs may be necessary. A MOPU usually has no propulsion system; it is floated into position by tugs. Once in place, a MOPU functions much like a fixed platform. MOPUs are most commonly used in shallower waters but some have been designed to work in water depths of over 500 feet.

### **3.5. Floating Production, Storage, and Offloading (FPSO) Vessels**

Floating production, storage, and offloading (FPSO) are large ships moored to a location for a long period and equipped with a variety of processing facilities to separate oil, gas and water. The FPSO allows oil companies to produce oil in remote areas and in deeper water than would have been economically possible with other technology, like fixed platforms. The FPSO's do not drill for oil or gas,

but are designed to process and store hydrocarbons produced by nearby platforms or subsea fields until the product can be offloaded onto a tanker or transported through a pipeline. Typical FPSOs are illustrated in Figure 3-5 and Figure 3-6.

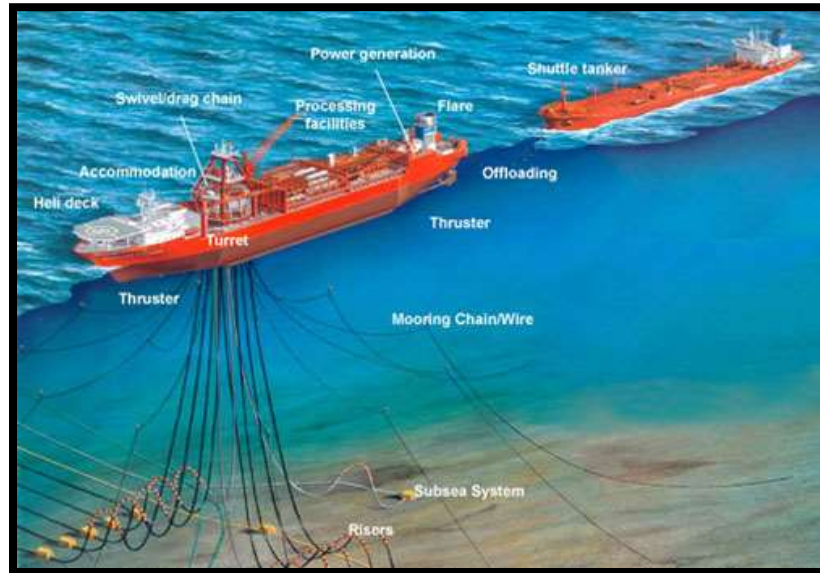

Figure 3-5. Typical FPSO

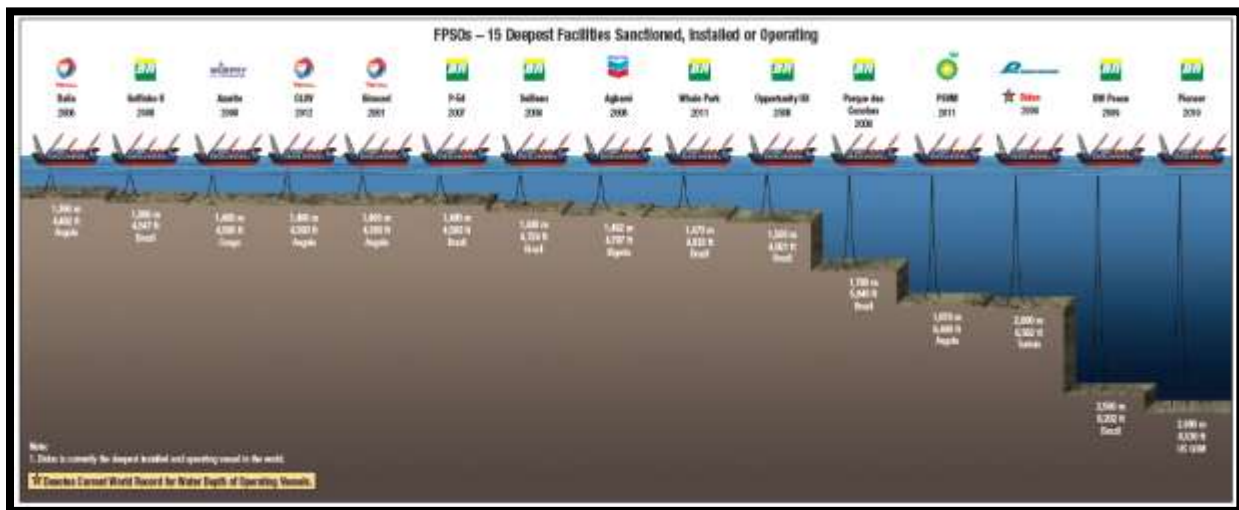

Figure 3-6. Representative FPSO's

### 3.6. Tension Leg Platforms (TLP) / Mini Tension Leg Platforms (MTLP)

Tension leg platforms (TLPs) are buoyant production multihull steel floating platforms vertically moored to the seafloor by a group of tendons to minimize vertical movement of the structure. The multihull supports a steel deck and equipment. The group of tendons at each corner of the structure is called a tension leg. A buoyant hull supports the platform's topsides and a mooring system keeps the TLP in

place. The mooring system may be steel or polymer cables, chains, rigid pipe or a combination of the same, all secured to piles secured to the seabed. The buoyancy of the platform's hull offsets the weight of the platform and maintains tension in clusters of tendons or tension legs that secure the structure to the foundation. The foundation consists of concrete or steel piles driven into the seabed. One common configuration uses four concrete piles with dimensions of 8' in diameter and 360' in length to anchor each tension leg, totaling 16 concrete piles. The typical deck surface of the facility covers around 65,000 sq/ft and, depending on the size and activity being performed onboard a TLP, the living quarters can house up to 100 people.

Mini TLPs are a smaller version of TLPs and typically contain a single vertical steel hull supporting a steel deck and equipment. pontoons located on the hull bottom are used to float the hull to the final installation location offshore. The pontoons are anchored to a mooring system similar to TLPs and can also be used as utility, satellite or early production platforms for larger deep water discoveries.

Dry tree wells are common on TLPs because of the limited vertical movement on the platforms. The platforms can have 50 well slots with provisions for satellite subsea well tiebacks. Pipelines for the TLP are the same as pipelines used for conventional platforms with diameters up to approximately 18" for oil and 14" for gas. A well's export pipeline will often connect to another pipeline for transport to shore. According to the BSEE database, the deepest TLP platform in the GOM is located in 4,670' of water at GB-783-A, also known as Magnolia and the deepest MTLP is located in 4,250' of water at GC-613-A, also known as Neptune. Typical TLP platforms are illustrated in Figure 3-7 and Figure 3-8.



**Figure 3-7. Typical TLP (MC-807-A)**

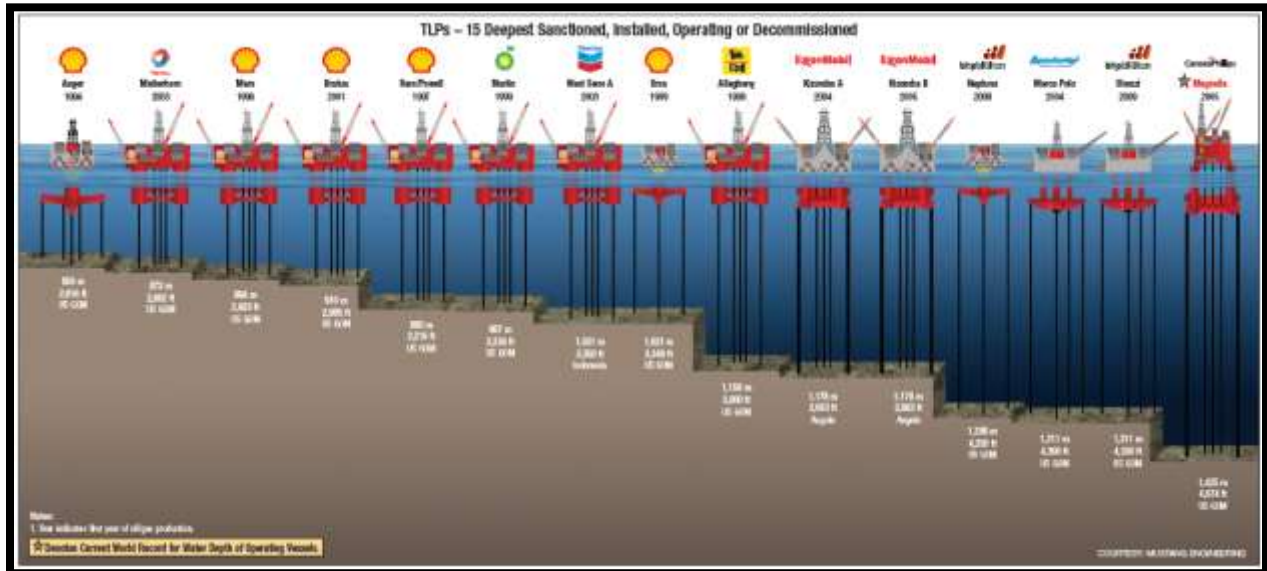

Figure 3-8. Representative TLP's

### 3.7. Semi-submersible Platforms (SEMI)

Semi-submersible platforms are floating structures that have submerged columns or hulls that are ballasted to maintain stability. The hulls have sufficient buoyancy to cause the structure to float and the submerged ballast keeps the structure upright. The platform can be lowered or raised by altering the amount of water in buoyancy tanks. Semi-submersibles remain on location either by mooring lines anchored to the seafloor or by dynamic positioning systems. They are used for both exploratory and development drilling and can be moved from place to place. According to the BSEE database the deepest Semi-submersible in the GOM is located in 8,000' of water at MC-920-A, also known as Independence. Typical semi-submersibles are illustrated in Figure 3-9 and Figure 3-10, platforms #7 and #8 are types of Semi-submersibles.

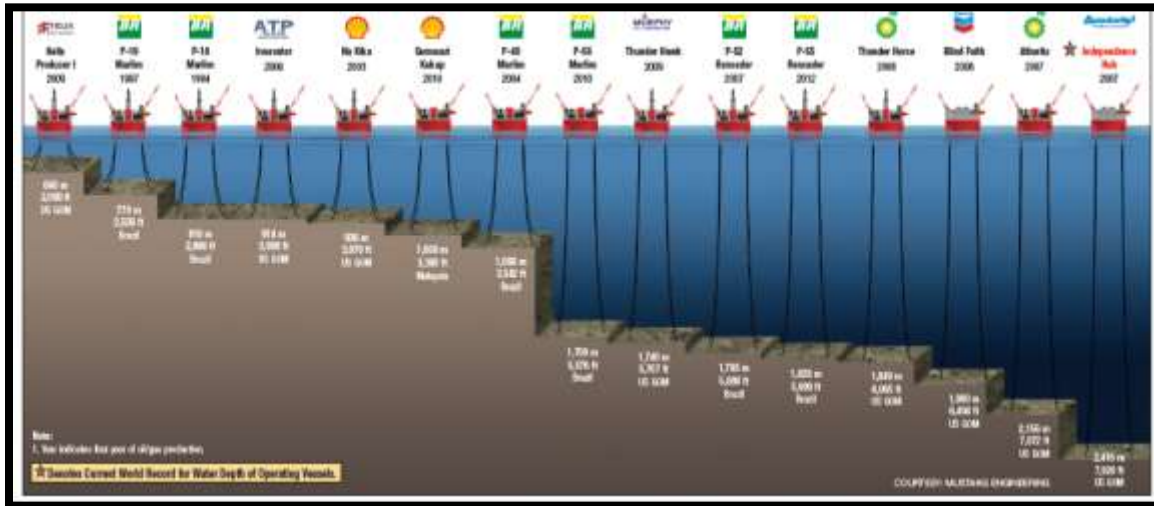

Figure 3-9. Representative Semi-submersible Platforms



Figure 3-10. Typical Semi-submersible

### 3.8. Spars

Spar platforms are similar to semi-submersibles in that they are floating platforms, but they differ in that they have a single ballasted structure for stability and buoyancy rather than multiple submerged columns or hulls. This structure may be a single large cylinder or may comprise a shorter cylinder for buoyancy connected by a truss to a deeper ballasted tank. Similar to an iceberg, the majority of a spar facility is located beneath the water's surface, providing the facility increased stability. Spars are moored to the seabed with conventional mooring lines. A spar may be more economical to build than a TLP for small and medium sized rigs. A spar also has the ability to move horizontally to position itself

over wells at some distance from the main platform location by adjusting the mooring line tensions using chain jacks. According to the BSEE database the deepest Spar in the GOM is located in 7,835' of water at AC-857-A, also known as Perdido. Typical spars are illustrated in Figure 3-11 and Figure 3-12.

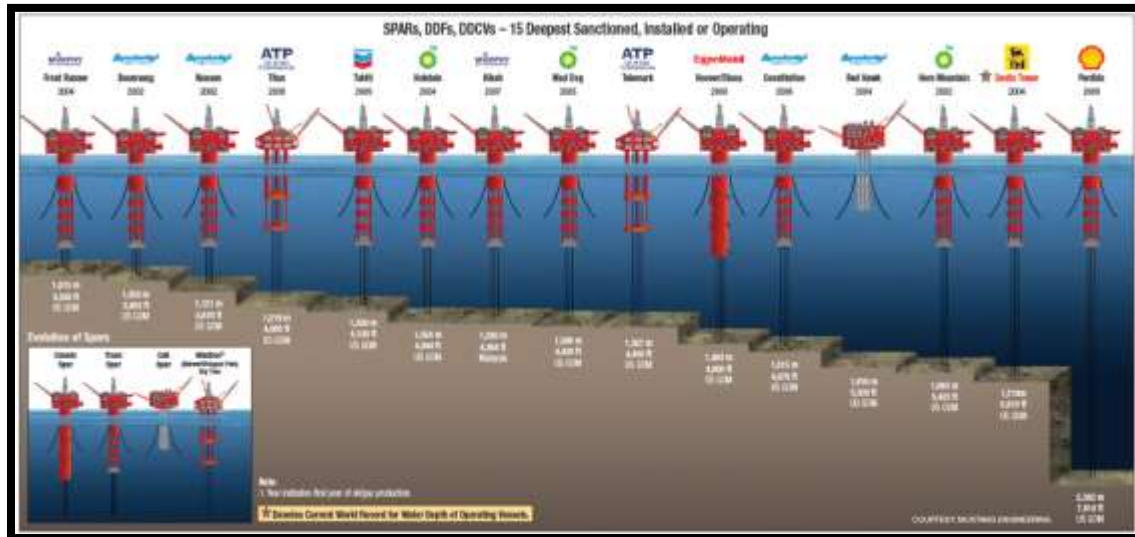

Figure 3-11. Representative Spars



Figure 3-12. Typical Spar (MC-773-A)

### 3.9. Well Protectors (WP)

Well protectors are multi-legged structures that are used as temporary or permanent means of supporting conductors during or after drilling and minimal equipment (heaters, small separators, telemetry, etc.). They are typically used in conjunction with manifold/production facilities when several wells are needed over a large area. The platforms can support single or multiple wells and will typically have one to four slots. The wells are typically drilled using a barge, jackup, or submersible rig. The platforms are configured to provide limited access for support of drilling and workover operations with

space for minimal production equipment but are not designed to support a drilling or workover rig. The piles may or may not be grouted to the jacket. The jackets without grouted piles can range in weight from 110 to 300 tons. A typical deck size is up to 30' x 30' and without equipment may weigh from 25 to 250 tons. . According to the BSEE database the deepest well protector in the GOM is located in 364' of water at HI-A385-D. Typical Well Protectors are illustrated in Figure 3-13 and Figure 3-14.



**Figure 3-13. Tripod Well Protector**



**Figure 3-14. 4-Pile Well Protector**

### 3.10. Subsea Templates (SSTMP)

A typical subsea template includes the following equipment; subsea manifolds, Pipeline End Terminations (PLETs), jumpers, subsea trees, and Umbilical Termination Assemblies (UTAs). Each piece of equipment is described below. Subsea templates typically cannot be installed in water depths less than 100' due to the height of the subsea equipment, as navigation clearance must be maintained. Figure 3-15 shows a diagram of a typical subsea template layout

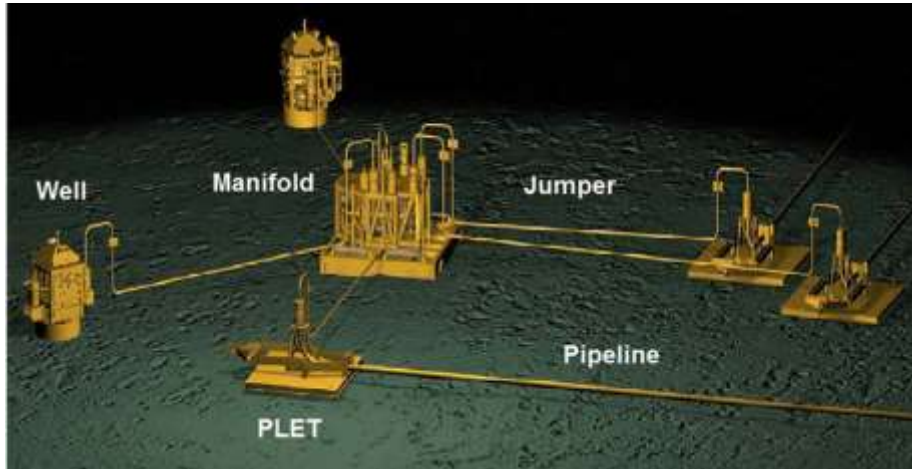

Figure 3-15. Typical Subsea Template Layout

#### 3.10.1. Subsea Manifolds

A subsea manifold is an arrangement of pipelines and valves designed to combine, distribute, control and monitor fluids. Subsea manifolds are installed within an arrangement of wells to collect production from all of the wells and are typically anchored with piles driven into the seafloor.

#### 3.10.2. Pipeline End Termination (PLET)

PLETs are designed to connect the end of a pipeline to subsea manifolds or subsea trees. A typical PLET will have a single hub with either a manual or remotely actuated valve installed. Unlike subsea manifolds, PLETs have pig launching and receiving capabilities.

#### 3.10.3. Jumper

A jumper is a short piece of pipe typically up to 160' in length that is used to send production fluid between two subsea components, for example, from 1) a subsea tree to a subsea manifold 2) a subsea manifold to another subsea manifold, 3) a subsea manifold to a PLET, 4) a PLET to the pipeline or 5) a SUTA to the umbilical. Jumpers are assigned segment numbers during permitting, with the exception of #s 4 and 5 above as they are considered to be the same segment number as the pipeline or umbilical to which they are attached.



### 3.10.4. Subsea Tree

A subsea tree is an arrangement of fittings, piping and valves that is located on top of a wellhead. The valves can be operated by a diver, ROV or remote control.

### 3.10.5. Umbilical

An umbilical includes a bundle of tubing, piping and electrical connections. Umbilicals are used to transmit fluids, electrical power, and control signals from the topside of a platform to subsea equipment to operate valves and power sensors. Umbilicals also return temperature, pressure, and other sensor information from the wells and subsea equipment to the operators on the platform.

### 3.10.6. Subsea Umbilical Termination Assembly (SUTA)

A SUTA is the subsea interface for an umbilical and serves as the delivery point for the required fluids and electric currents to operate the subsea equipment.

## 3.11. Distribution of Structure Types

Table 3-1 shows the distribution of the 2,475 Major Asset Platforms located in the Gulf of Mexico (GOM) identified in the BSEE database. Numerous public sources including BSEE and other websites were visited to obtain information on the GOM major assets and characteristics of the various types of platforms. Some of the sources of information provided conflicting data and the data believed to be most reliable information was used in this study. Figure 3-16 shows the history of platform installation in the GOM, including the evolution of structure types as operators moved into deeper and deeper water.

**Table 3-1. Existing Structures in the GOM**

<b>Structure Type</b>	<b>0' to 400'</b>	<b>401' to 800'</b>	<b>801' to 2,000'</b>	<b>&gt; 2,000'+</b>
Caisson	578	3	0	0
CT	0	0	3	0
Fixed	1,586	44	8	0
FPSO	0	0	0	1
MOPU	0	0	0	1
MTLP	0	0	1	3
SEMI	0	0	0	9
Spar	0	0	1	15
TLP	0	0	2	10
WP	210	0	0	0
<b>Totals</b>	<b>2,374</b>	<b>47</b>	<b>15</b>	<b>39</b>

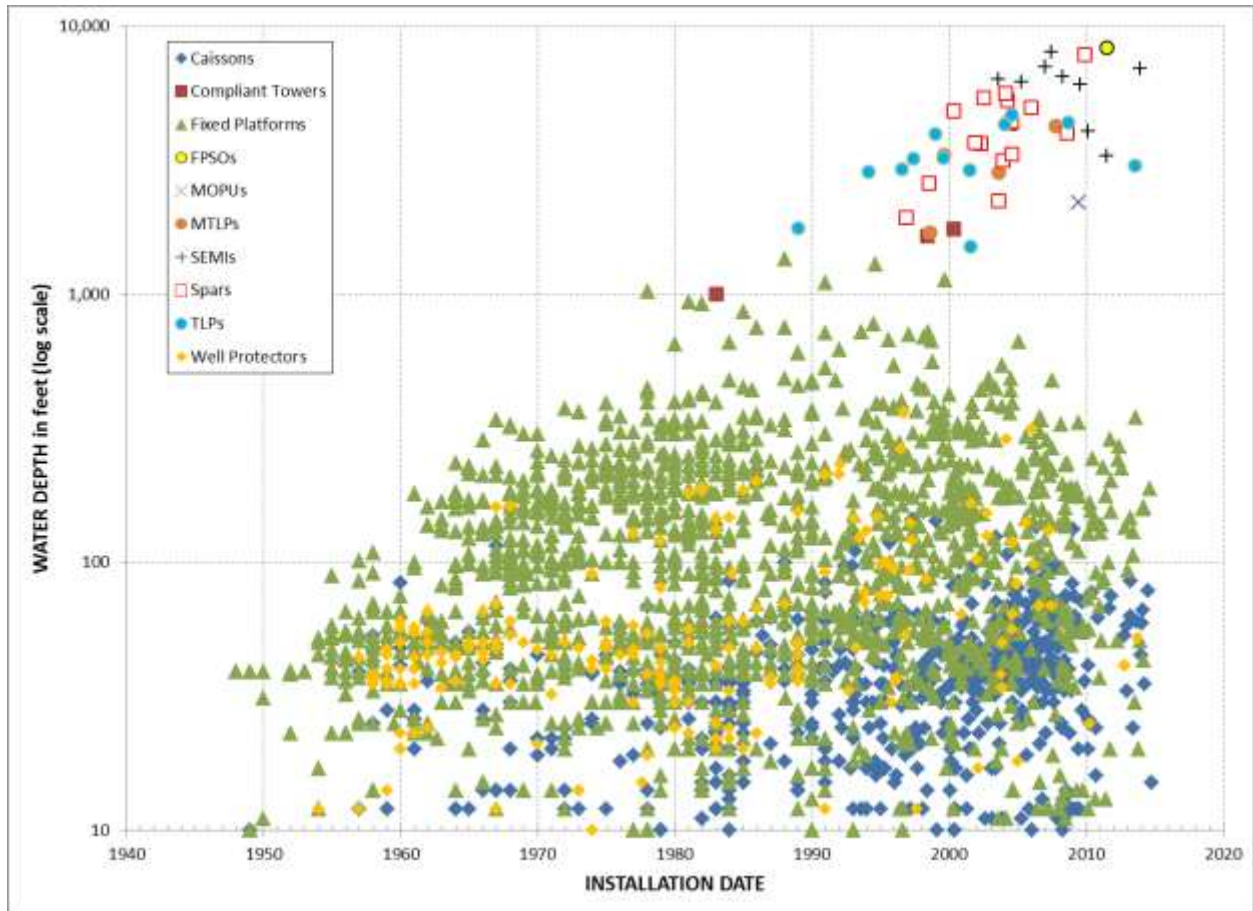

Figure 3-16. History of Platform Installation in the GOM

## 4. The Decommissioning Process

This section provides an overview of the decommissioning process from planning to offshore operations for well, pipeline and platform abandonment.

To date, nearly all decommissioning activities in the GOM have been on structures in water depths <400'. With the exception of a few isolated decommissioning platforms globally, no other decommissioning activity has occurred. As decommissioning activities move into deeper water and to tensioned and moored structures, some of the current technology may need modification or may prove inadequate. This section focuses on the mature areas of development and present emerging developments along with the latest development in technologies and technique will be discussed in section 5.0 of the report.

### 4.1. Pre-job Activities

Before any physical decommissioning work can commence, a number of pre-job activities must be completed. The pre-job components of a decommissioning program consist of the following activities:

- Decommissioning Planning
- Decommissioning Engineering
- Permitting
- Bidding
- Pre-job Meetings

#### 4.1.1. Decommissioning Planning

Decommissioning planning includes gathering and reviewing platform, pipeline and well information, preparing a decommissioning estimate, and performing an inspection of the platform. This is the initial phase of the decommissioning project. All information available for each platform to be decommissioned (structural drawings, installation records, process flow diagrams, pipeline maps, etc.) is first gathered and reviewed. Based on the information retrieved, various removal methods (i.e., Complete Removal, Partial Removal, and Remote Reefing) may be evaluated. An Approval for Expenditure (AFE) cost estimate for each platform is developed and submitted to the platform owner for approval. In cases where multiple platforms are to be decommissioned, this AFE will consider grouping the platforms to realize any economies of scale. In some instances different operators will join together to share the same deep water equipment for a multiple platform decommissioning program. All assumptions made are noted on the AFE. Concurrently, a detailed project schedule is developed.

After the AFE is approved, the platform is inspected above and under water to appraise the overall platform condition, drilling and production deck dimensions, equipment location, pad eyes, risers, etc. A detailed inspection punch list is submitted to and agreed upon with the platform owner prior to these inspections.

TSB recommends conducting a pre-contracting underwater survey of the jacket and seafloor for larger and older platforms. The dive crew would survey the sea floor for debris that would hamper the platform removal and inspect the jacket for flooded and/or damaged members and conductors.

For conventional steel-jacket platforms located in shallow<sup>5</sup> depths, TSB recommends a six-month lead-time for decommissioning planning. However, deep water decommissioning planning requires a longer lead-time because of the limited availability of deep water removal equipment. Therefore, a minimum of two years lead-time is recommended for planning the decommissioning of deep water platforms. For complete removal, equipment contracting alone will require at least one to two years lead time.

#### 4.1.2. Decommissioning Engineering

Detailed engineering is carried out to determine the specific procedures, vessels, equipment, and manpower that may be used in the decommissioning process. The analyses include the determination of the weights of individually removed pieces, crane and vessel capacities, and the structural stability of the platform at all stages of the dismantling process.

A project management group is established with owner and/or operator personnel and may also include an outside project management consultant. The contractor will join the group after bids are reviewed and the contractor is selected.

A major consideration is the ability to safely remove platform components and sections. Deck and jacket actual weights, the center of gravity, and the center of buoyancy are needed for the platforms and major subsea equipment. Lift analyses are developed by structural engineers; all calculations are reviewed and approved by the project manager.

Additionally, pipeline operators of connecting pipelines are contacted to coordinate pipeline decommissioning activities.

#### 4.1.3. Permitting

Permits required by the Bureau of Safety and Environmental Enforcement (BSEE) for the decommissioning of offshore structures are as follows:

- Well P&A Sundry Notices and Procedures
- Pipeline Abandonment Permits
- Platform Removal Permits
- Reefing Permits (if applicable)
- Incidental Take Statement

---

<sup>5</sup> Definitions for water depth variations -- Shallow water – less than 50 ft, Standard water - 51 ft – 399 ft, Deep water – greater than 400 ft

- Site Clearance Verification Procedures

Each platform, well, and pipeline will require their specific permits. The project management group prepares all permits, along with any necessary attachments. The permit requests are submitted to the platform owner for review and approval. Once approved, the project management group submits the requisite number of copies to the appropriate BSEE office for approval and issuance of permits.

#### 4.1.4. Bidding

The project management group work together to determine the manner by which bids will be developed to take advantage of the amount of work to maximize economies of scale.

The project management group prepares a suggested list of qualified contractors for each phase of the job; the platform owner then reviews, revises (if necessary) and approves the list. The bid books are prepared by the project management group and are submitted to the owner for approval. Once approved, the approved contractors are sent the Requests for Quotation (RFQs).

Proposals submitted based on these RFQs are reviewed by the project management group who develops a spreadsheet containing all contractors' rates. This spreadsheet, along with a recommendation for award, is sent to the platform owner for review and award of the work.

#### 4.1.5. Pre-job Meetings

Prior to commencing any offshore work, pre-job meetings are conducted with each contractor, the project management group, and the platform owner's representatives. The goal of these meetings is to establish that all parties involved understand the Scope of Work, operational and safety procedures, reporting requirements, etc. The project management group is responsible for coordinating these meetings by contacting the parties involved, setting the time and location of the meeting, preparing the meeting agenda, and recording and distributing meeting notes.

## 4.2. Well Plugging and Abandonment

### 4.2.1. Problem Free Wells

Production wells that can no longer be used must be plugged to prevent the oil and gas reservoir fluids from migrating up hole over time and possibly contaminating other formations, fresh water aquifers, or the marine environment. A well is plugged by setting mechanical or cement plugs in the wellbore at specific lengths and intervals to prevent fluid flow. The main rigless plugging process usually requires a spread containing the following: pump, cement blender, a combination wireline/ electric line unit, mud tank and commonly used materials such as cement, bridge plugs, and cutting equipment to conduct the operation. The plugging process can take from 7 to 10 days, depending on the number of wells on the structure, any issues in wellbore, and the service provider. The P&A work takes capital to complete and

provides no return on the investment for the oil companies, so most wells are plugged at the lowest cost possible following the minimum requirements set forth by the oil and gas regulators.

After production ceases from the platform, the wells are plugged and abandoned<sup>6</sup>. Once the well P&A crew mobilizes and sets up on the platform, it performs diagnostics (establishes injection rates into the well for killing fluids and cement runs and runs wireline surveys) to determine the status of each well.

P&A operations include the following steps to properly seal the well, remove well components, and isolate all water-bearing and commercial producing zones:

- Squeeze all perforations with cement.
- Set intermediate plugs.
- Cut and remove the tubing at approximately 300 ft below the mudline to allow space for a 200 ft. cement plug.
- If the production or surface casing annuli are not grouted, then a cement plug is set to isolate the casing.
- A Cast Iron Bridge Plug (CIBP) is set above the point the tubing is cut.
- A 200 ft balanced cement plug is set above the CIBP and tested.
- Once tested, all casing and conductors are cut at 15 ft below the mudline.

Alternatively, a typical well temporary abandonment (T&A) is performed where all plugs are set and the conductor and any grouted casings are severed and removed during or prior to platform removal operations.

During well abandonment projects it is imperative that adequate seals are placed in the wellbore to permanently seal the well. This is a challenge in deep water wells especially in subsea wet trees. The challenge is greatly increased for wellheads without access fittings to all casing annulus sections. Wellheads should be designed with full access to all casing strings which will reduce well decommissioning costs.

Another decommissioning cost savings well design factor is to place the production packer below the top of cement in the production casing. The packer should be placed far enough below to allow sufficient space for the cement plugs needed to eventually seal off the well.

Ideally all permeable zones above the production casing show should be sealed off with cement during the drilling of the well. For the most part it is easier and less expensive to seal off these zones during the well drilling operation than during a decommissioning project.

---

<sup>6</sup> Well plugging and abandonment (P&A) is common industry terminology for permanently decommissioning wells. Although some components such as tubing or casing may be physically removed, as opposed to abandoned in place, the term “abandonment” is most frequently used for well decommissioning activities.

### 4.2.2. Problem Wells

A problem well can be any well that does not have sufficient integrity to continue producing oil and gas due to factors such as those shown below:

- Improper cementing of casings and annuli which can develop bubbles or fluid leakage,
- Damaged or collapsed casing and tubing,
- Sustained casing pressure which requires the use of expensive intervention methods such as snubbing or hydraulic workover,
- Obstructions in the tubing, e.g., stuck plugs or lost tools from previous operations, which require fishing operations,
- Paraffin scale or sand development in the tubing which requires coil tubing intervention to clean out the wellbore,
- Frozen valves on the wellhead,
- Presence of H<sub>2</sub>S or CO<sub>2</sub> production,
- Displacement of heavy water or oil base mud, or
- Heavily deviated wells that require special tools such as a roller stem for operation.

### 4.3. Pipeline Decommissioning

Pipelines may be either removed or, with a waiver, abandoned in place. Prior to removal, pipelines must be pigged and flushed with water. Pipelines abandoned in place must be flushed, filled with seawater, cut, and plugged with the ends buried at least 3 feet. Pipelines that are abandoned in place must not pose hazards to navigation hazards, commercial fishing, or other marine activities.

### 4.4. Platform Decommissioning

The platform removal process is inclusive of the following operations; platform cleaning, conductor removal, deck and equipment removal, jacket or hull removal and disposal. The description of each operation is described below.

#### 4.4.1. Platform Preparation and Cleaning

Platform preparation includes the procedures associated with shutting down and preparing the facility for removal. Level I topside inspections and Level II underwater inspections are generally conducted to determine the condition of the structure and to identify any problems for removal. Divers will perform the underwater inspection in water depths ranging from 0' to 200' and remotely operated vehicles (ROV's) will perform the underwater inspections from water depths ranging from 200' to 1,200'. After the inspections have been completed, a crew paid on a day rate or fixed price bid prepares the structure for decommissioning after the wells have been permanently plugged and abandoned and the pipelines have been abandoned.

On the surface (topside of the platforms), the work includes the flushing/cleaning and degassing/purging of tanks, processing equipment and piping, disposal of residual hydrocarbons, removal of platform equipment, cutting of piping and cables between deck modules, separation of modules into individual units, installation of padeyes for deck module lifting, removal of obstructions to lifting, and structural reinforcement. Topside preparation also includes severing connections between the deck and jacket and verifying that all pipelines have had a section of pipe removed between the deck and jacket. If not, the crew removes a section at the +10 elevation.

Where permitted, marine growth can be removed from the structure at sea; otherwise it produces very foul odor during jacket disposal onshore. Shell mounds arise from the shedding or removal of the shells of mussels, barnacles, rock scallops and other invertebrates that attach themselves to platform jackets. Removal of marine growth at sea may contribute to the creation or expansion of shell mounds. A 2014 BOEM study concluded that the chemical concentrations in shell mounds pose no appreciable risk to marine biota. Shell mounds are defined as obstructions in 30 CFR 250.1700; 30 CFR 250.1703 requires the clearance of all obstructions. However, the need for shell mound removal is often reviewed on a case-by-case basis.

The key factors affecting the cost of platform preparation include structure size and complexity, topsides equipment (especially the amount of processing equipment), and age of the facility. The costs can vary widely depending on the type of facility, removal procedures, and transportation and disposal options.

#### 4.4.2. Conductor Severing and Removal

The conductors can be removed prior to the HLV arrival or removed during platform decommissioning operations with the HLV. All conductors are severed and completely removed at least 15 feet below the mudline. The conductors are severed by one of the following methods:

- Explosives
- Abrasive Cutting
- Mechanical Cutting
- Diamond Wire Cutting

One or a combination of the following are used to pull the conductors:

- Casing jacks
- Platform's drilling rig, if present
- Platform crane
- The crane on a HLV

Regardless of the lifting device, the removal sequence is the same. The conductor is pulled upward until a 40-foot section is exposed. The conductor is cut using external mechanical cutters or possibly the threaded connections are unscrewed. The cut section is then removed by the drilling rig or platform crane and placed on a workboat, cargo barge or on the deck away from the work area. This procedure



(pull, cut and remove) is repeated until the entire conductor is removed. The jacks onboard may not be able to pull the combined weight if the conductor is grouted. In this case, a rig or crane is used until the jacks can pull the weight of the conductor by themselves.

#### 4.4.3. Removing Deck and Modules

Topsides removal follows the installation process in reverse sequence. Some deck removals will require that modules are removed and placed on a cargo barge. The module is secured by welding pieces of steel pipe (or plate) from the module to the deck of the cargo barge. If the deck is planned to be lifted in multiple sections; e.g., removing two 4-legged section from an 8-legged deck, the deck is severed into two section, the connection between the deck and jacket are severed and each section is lifted and placed on a cargo barge and the legs are secured to the deck by welding.

One of the emerging decommissioning processes will be deck removal by the floatover method. This has not been a method of installation or removal because HLVs of sufficient size have not existed until recently. A specially designed vessel was used that can be partially submerged by ballasting and raised by deballasting as shown in Figure 4-1 and Figure 4-2.



**Figure 4-1. Deck Ready to Be Installed**



**Figure 4-2. Deck Installed**

#### **4.4.4. Jacket / Hull Removal**

Platform jackets or hulls may be decommissioned using one of the following alternatives - complete removal, partial removal, or remote reefing. These alternatives vary only in the methods used to remove the jacket or hull. For any given platform type, the platform removal preparation, well P&A, and pipeline decommissioning are the same for all removal alternatives.

##### **4.4.4.1. Fixed Structures, Complete Removal**

Jacket removal involves separating the structure from its foundation and transporting it in whole or in pieces to a scrap yard where it is cut up and recycled.

The majority of jackets are separated from their foundations with explosives although non-explosive removal techniques are becoming more common.

When explosives are used during a platform removal, regulations require a pre-blast aerial survey for resident marine mammals immediately prior to the explosive detonation. This survey is performed using a helicopter with a National Marine Fisheries Service (NMFS) observer onboard to determine if there are marine mammals in the area. If marine mammals are found near the platform, the explosive detonation is delayed. The detonation delay will last until the marine mammals are safely out of the area. Once the explosives are detonated, a post-blast aerial survey is conducted.

Explosives are placed in the main piles and skirt piles at least 15 ft below the mudline. If the mud plug inside the piles is not deep enough to allow the explosive charge to be placed at the required depth, the mud plug is jet/air lifted.

If it is necessary to reduce the jacket weight because the HLV does not have sufficient lifting capacity to overcome the jacket weight and bottom friction, the severed jacket is made buoyant to reduce the effective weight. To maximize buoyancy, closure plates are welded on the top of each pipe pile and water is forced out using compressed air. A hose from an air compressor is connected to a valve on each closure plate. The valve is opened and compressed air is forced into the piles. As the air pressure inside a pile increases, the water is forced out of the bottom of the pile where it was severed, deballasting the pile. When all of the water has been displaced from a pile, air bubbles appear on the surface of the water near the jacket. After deballasting the jacket, it is lifted off the sea floor by the HLV. The jacket is loaded onto a cargo barge if possible and transported to shore for disposal.

If the jacket is too large for loading on a cargo barge, the jacket is towed to shallower water. Although this method, also called jacket hopping, has only been used rarely to date, it is being considered for larger jackets because it allows the use of smaller, less expensive, and more available HLVs. The jacket is supported by the HLV's crane and swung to the stern of the HLV. Rope hawsers are passed around two of the jacket legs and secured to the stern of the HLV. The jacket is then boomed away from the stern of the HLV until the hawsers are tight. The rope hawsers keep the jacket from swinging and being pulled out of the boom radius by its movement through the water. The HLV's anchors are shifted and the jacket is towed to shallower water.

At the new location, the jacket is ballasted and set on the sea floor. The water depth at the new location is such that the elevation to be cut is several feet above the water. Welders set up scaffolds around the jacket legs and begin cutting the jacket legs. Additionally, larger jackets may be cut in half vertically to create two 4-leg sections or three 4-leg sections. The diagonal braces running between each set of rows are cut.

After the legs and piles have been cut and the diagonal braces removed, the jacket section is rigged, lifted, and sea-fastened on a cargo barge. For an eight-leg jacket, two four-leg sections are removed at the bottom elevations. The cargo barge is then sent to the onshore disposal yard.

At times, the jacket is severed at multiple elevations because of its dimensions. The jacket is deballasted, picked up, towed to shallower water, set, cut in two (vertically), and removed in sections. This procedure is repeated until the jacket is completely removed and placed on cargo barges. Each time the jacket is moved, the HLV's anchors are repositioned.

#### **4.4.4.2. Fixed Structures, Partial Removal**

This scenario involves removing only the top section of the jacket. The jacket's legs are severed as in complete removal, except that the cuts are made at the top of the portion of the jacket that will remain in place. The remaining structure must not become a marine obstruction. This removed section of the

jacket will either be transported to shore for disposal or reefed in place or at another approved reef location.

#### **4.4.4.3. Fixed Structures, Reefing**

After the topsides are removed the jacket is severed as in the complete removal method. If the jacket is to be transported to an alternate reef site, the jacket is then made buoyant as in the complete removal method.

Reefing may involve complete or partial removal of the jackets. Structures may be reefed in place or reefed at another approved location. The jackets are severed below the mudline (for complete removal) or severed at some partial depth (for partial removal) as described above.

Reefing the jacket in place involves preparing the jacket so that it can be toppled whole or in sections by a tug. For partial removal, the top portion of the jacket is cut into sections that can be toppled. All cuts are performed before the vessel (e.g., a large tug, approximately 12,000 hp) arrives on site to minimize the amount of time the tug is used. Additionally, rigging is set up in advance of the tug's arrival and is designed to release once the jacket or jacket sections topple over. A large jacket may be toppled in multiple sections.

If the jacket is reefed at an alternate approved reef site, the jacket is transported to the site by the HLV or by pull tugs. At the reef site, the jacket is lowered by ballasting the piles and the base is set on the sea floor. The jacket is pulled over and left on its side at the reef location with a marker buoy placed on location above the jacket.

#### **4.4.4.4. Floating Structures**

Floating structures are moored to piles installed in the seabed with steel pipe, steel or polymer cables, steel chains, or a combination thereof. The mooring lines are released from the hull and the hull is towed to a shore disposal facility. The mooring lines are severed from the anchor piles and removed.

Tensioned or moored structures (TLPs, FPSOs, Spars, SEMIs) are not candidates for partial removal and are removed completely. Spars have been considered for reefing removal as in the recent reefing of the Red Hawk. The difficulty in removing spars completely is managing the installed ballast, which is often steel and ore that turns into a solid or concrete-like material that cannot be removed. Other tensioned or moored hulls could be considered for reefing much in the way that ships are sunk off the coast.

### **4.5. Disposal**

The cargo barge transports the deck and modules to a scrap yard. The modules may be lifted with cranes or skidded off the barge to the yard. Once the modules have been removed from the barge, the deck is skidded off the barge to the yard. All of the structural components and modules are cut into

small pieces and disposed of as scrap unless the deck will be reused. The production equipment is salvaged for reuse whenever possible.

#### **4.6. Site Clearance and Verification**

Following removal, the platform site and any location where the jacket is cut will be cleared of debris and verified that it has been cleared. The site is cleared by the use of trawlers dragging nets across the bottom in a recorded grid pattern of specified dimensions or by the use of other authorized methods per 30 CFR 250.1740. Service providers follow NTL No. 98-26 Minimum Interim Requirements for Site Clearance (and Verification) of Abandoned Oil and Gas Structures in the GOM. Any trash that is retrieved from the sea floor is transported to shore for proper disposal.

#### **4.7. Post-job Activities**

Each decommissioning phase requires a report be submitted to BSEE. These reports are submitted to the platform owner for review and approval. Once approved, the project management group submits the reports to the appropriate BSEE office.

## 5. Facility Decommissioning Techniques and Methodology

### 5.1. Well Plugging and Abandonment

Well plugging and abandonment involves isolating hydrocarbon bearing zones from water bearing zones, creating barriers to prevent leakage of hydrocarbons from the well into the sea, and removing well components.

#### 5.1.1. Planning for Well Abandonment

When planning to plug and abandon a well, the following data should be collected and stored in a database (by either the well operator or the company performing the abandonment) for current and future well abandonment programs:

- Present well schematic
- Well completion information
- Well test report
- Bottom hole pressure survey report
- Recent wireline reports
- Well head and tree details
- Tubing details
- Casing details and cementing information for each string
- Directional survey and casing collar log

#### 5.1.2. Isolating Well Zones

A typical well consists of a series of concentric pipes or casings that are used to support the hole, access the well and oil and gas bearing formations, and convey fluids. Upon abandonment, the flow pathways used to extract the hydrocarbons must be sealed to prevent future flow and leakage. Different sections of the well require different isolation techniques, as detailed below. (Also see 30 CFR 250.1715)

##### 5.1.2.1. Zone in open hole

- A cement plug is set at least 100' below the bottom to at least 100' above the top of oil, gas, and or fresh water formation to isolate fluids in the strata

##### 5.1.2.2. Open hole below casing

- A cement plug is set with displacement method at least 100' above and 100' below the deepest casing shoe;
- A cement retainer or plug needs to be set within 50' to 100' above the casing shoe and a cement plug that extends at least 100' below the casing shoe and at least 50' above the retainer; or

- A mechanical bridge plug needs to be set within 50' to 100' above the casing shoe with 50 feet of cement on top of the bridge plug.

#### 5.1.2.3. Perforated zone

- A method to squeeze cement used to isolate all perforations. Cement squeezing involves injecting cement slurry under pressure to fill all target voids, in this case the perforations in the well casing and voids in the surrounding formation.
- A cement plug (displaced) is set by the displacement method to at least 100 feet above to 100 feet below the perforated interval, or down to a casing plug, whichever is less.
- A cement plug (displaced) at least 200 feet in length, set by the displacement method, with the bottom of the plug no more than 100 feet above the perforated interval.
- If unable to squeeze perforations, a cement retainer or thru tubing bridge plug with effective back-pressure control is set 50 to 100 feet above the top of the perforated interval, and a cement plug is then squeezed below the retainer that extends at least 100 feet below the bottom of the perforated interval and at least 50 feet on top of the retainer or tubing bridge plug.
- A tubing plug is set no more than 100 feet above the perforated interval and is topped with a sufficient volume of cement to extend at least 100 feet above the uppermost packer in the wellbore and with at least 300 feet of cement in the casing annulus immediately above the packer.

#### 5.1.2.4. Casing stub with the stub end within the casing

- A cement plug is set at least 100 feet above and below the stub end.
- A cement retainer or bridge plug is set within 50 to 100 feet above the stub end with at least 50 feet of cement on top of the retainer or bridge plug.
- A cement plug at least 200 feet long with bottom no more than 100 feet above the stub end.

#### 5.1.2.5. Annular space that permits flow to the mud line

- A cement plug at least 200 feet long is set in the annular space. For a well completed above the ocean surface, each casing annulus must be pressure tested to verify isolation

#### 5.1.2.6. Well with casing

- A cement surface plug at least 150 feet long is set in the smallest casing that extends to the mud line with the top of the plug no more than 150 feet below the mud line

### 5.1.3. Setting and testing plugs

- A minimum of two independent barriers are set, one of which must be a mechanical barrier in the center wellbore tubing and a cement plug in tubing.
- Test the first plug below the surface plug and all plugs in lost circulation areas that are in open hole. The plug integrity is tested by applying a weight of 15,000 lbs of seawater on the plug or by pressure

testing the plug to 1000 psi for 15 minutes. (see 30 CFR 250.1715(b) --- other plugs may be required to be tested as well)

#### 5.1.4. Severing tubing and casings

- Production tubing is cut at least +/- 400' BML (usually below the surface controlled subsurface safety valve, SCSSV) and then removed.
- Production casing is cut at least +/- 380' BML and removed.
- A mechanical barrier is set at 300' BML (e.g., bridge plug in surface casing with at least 200' cement on top of the plug to make a TOC at +/- 100' BML) to complete the temporary abandonment procedure.
- Remaining casing (i.e. surface, conductor, and drive pipe) is cut and removed at least 15' BML as part of a permanent abandonment program. According to 30 CFR 250.1716, alternate depth for cutting and removal is subjected to approval by District Manager.

#### 5.1.5. Rig vs. Rigless Well Abandonment

This section presents a summary of the procedures used to P&A wells. The discussion includes the differences between rigless well P&A and well P&A with a drilling or workover rig.

##### 5.1.5.1. Advantages of Rigless Abandonment

“Conventional” well P&A was based on the premise that if rigs are used to complete the well, a rig should be used to P&A the well. Rigs are relatively large and expensive structures that are always involved in the drilling and completion of wells. Until the 1980's they were also almost always used to plug and abandon wells. In the early 1980's, well P&A costs became a concern to operators and they sought less expensive methods. First, operators found ways to decrease the use of rigs in plugging and abandoning wells. Ultimately, they stopped using the rigs altogether for P&A work on platform wells. This "rigless" P&A method underwent refinement through the mid 1990's. One major factor in the reduction of time to abandon wells was the perfection in the methods in which cement plugs were circulated without running a work-string.

Rigless P&A has many advantages over Rig P&A, including those listed below:

- No use of expensive rigs, freeing rigs for drilling and well completion
- Lower daily rate (30% or less of the cost of a rig spread)
- Higher availability of rigless P&A spreads than of rigs
- Quicker mobilization and set up
- Reduced work time
- Faster running in and out of well
- Ability to work on multiple wells concurrently
- Smaller BOP
- Smaller crane
- More flexibility in deck positioning



- Smaller deck footprint
- Lower deck loading
- Fewer personnel required
- Eliminates much of the pulling and salvage of low value tubing and casing (by leaving the tubing in place)

Nevertheless, there may be some complicated situations that require a drilling rig, such as problem wells with tubular defects or with heavy sand or paraffin buildup (to name a few).

A rigless well P&A spread typically includes the work crew, support vessels, cranes or casing jacks, wireline equipment, a high pressure pump, a fluids handling tank, a “gas buster” to separate gas from well fluids, a cement blender, a mud mixer, cutting equipment, and coil tubing equipment.

A typical 5 man crew working a 12-hour shift includes 1 supervisor, 1 pump operator, 1 electric line operator, 1 slick line operator, and 1 helper. A 24-hour operation would include two such crews, plus a coordinator. By comparison, a crew for rig P&A would typically include 13 workers due to additional rig and pump operators.

#### 5.1.5.2. Methodology

Before the cessation of production, each well must be surveyed to determine the exact P&A method and the number of cement plugs the well requires. Each additional permanent barrier is placed at depth as required, the last being a surface plug. The conductor is cut, leaving all annuli plugged. Each well requires at least three permanent cement barriers (in combination with mechanical plugs).

The well P&A can start upon cessation of production. An integrated work crew of cement personnel, and slick-line and electric-line personnel will work at the same time on different wells. Any well condition that does not conform to the procedures will be temporarily deferred while work continues on other wells. The equipment and procedures will be adjusted as necessary. After work has started on the wells and initial diagnostics are complete, the crew may determine how many wells (if any) require a coiled-tubing unit in the well P&A. Before investigating each well, the crew may assume that, on average, one-fourth or less of the wells will require a coiled-tubing unit.

There are no differences in the results of rig versus rigless methods in the final examination of each plugged and abandoned well. Both Rig and Rigless P&A involve several steps, generally as follows. Figure 5-1 shows two identical wells that will be plugged and abandoned, one with each method. A cementing unit mixes and pumps cement batches through the tubing placed in the wellbore. This is the first of at least three cement plugs that will be placed at different depths. Figure 5-2 shows these wells after the bottom plugs have been set with the tubing having been pulled out of the well on the Rig method. The P&A crew verifies the top of cement plugs by tagging it with the drill pipe (rig method) or the slick-line unit (rigless method), checking for flow (bubbles), then pressure testing the top of the plugs (see 30 CFR 250.1715 (b) for plugs that are applicable). Figure 5-3 shows the balanced cement plug with the rigless method and the spotted cement plug with the rig method. This second plug is also tagged and tested.

Remember, with the rigless method, the tree is still on while the rig method uses BOP's which have to be tested. Figure 5-4 shows the rigless method having cut the production casing, and a CIBP set with 200+ feet of cement on top. The rig method shows the same with a little more casing out of the hole. The well casings are cut fifteen feet below the sea floor with an electric line and an abrasive cutter or mechanical cutter. The casing is then pulled by the casing jacks, crane, or drill rig.

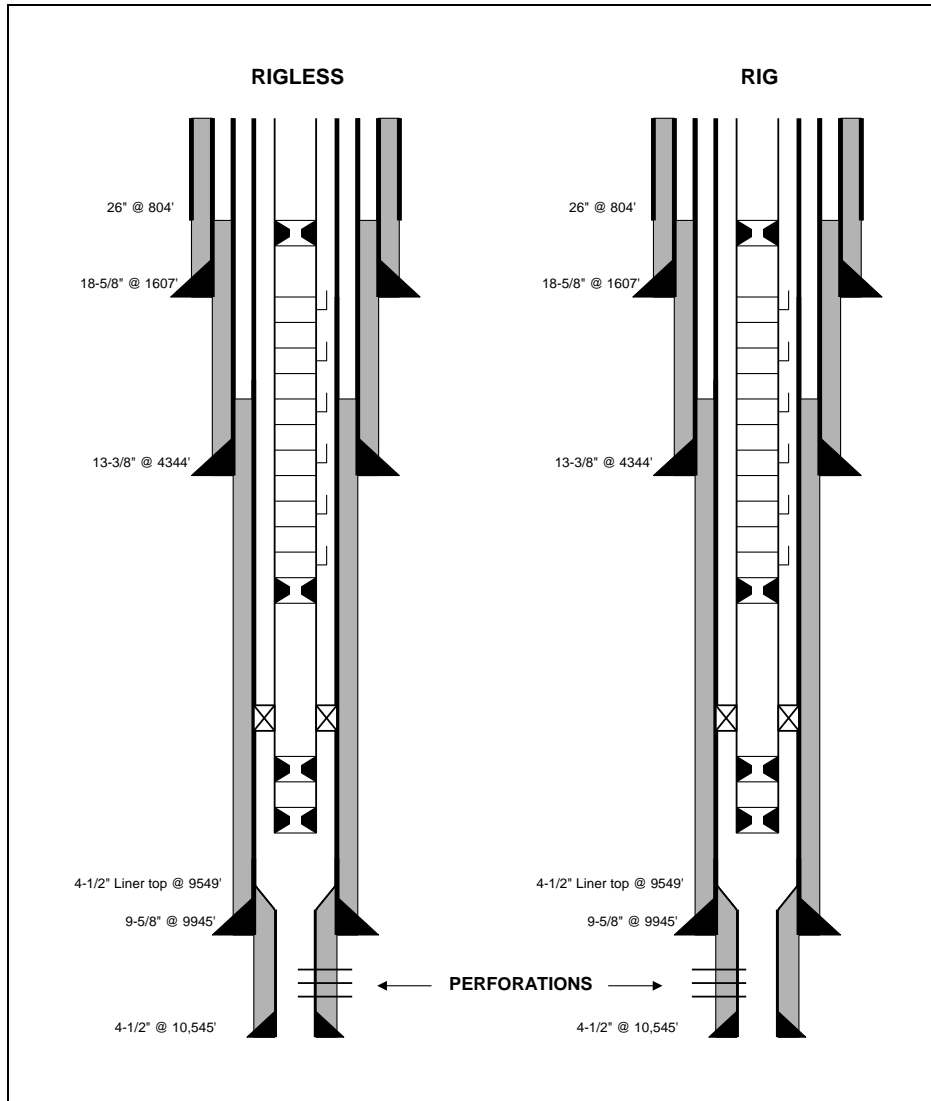

**Figure 5-1. Typical Wellbore Schematic**

(Note: The two wells are the same for comparison purposes)

**Rigless**

- P&A Crew (6)
- Main Equipment
  - WL & EL units
  - Cementing & sand units
  - Crane

**Rig**

- Regular drilling crew (5)
- Wire-line crew (2)
- Cementing personnel (2)
- Main Equipment
  - Rig

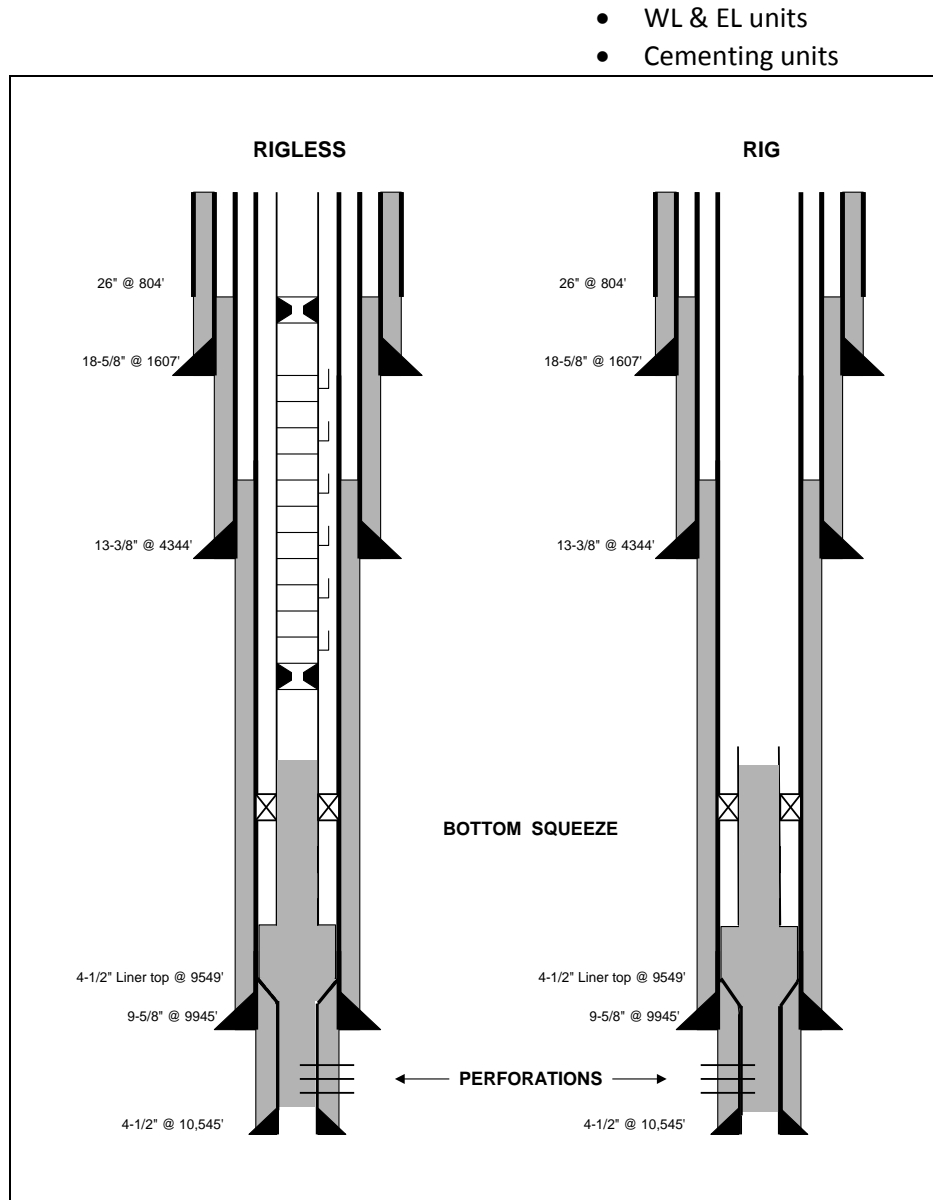

Figure 5-2. Bottom Plugs Set with Tubing Pulled Out of Hole

**Rigless**

- Tubing is left in the well
- Production zone is squeezed/isolated
- Tree is still on the well
- Cement is left above the packer

**Rig**

- The tubing is pulled from above the packer or at packer
- Production zone is also squeezed/isolated
- BOP's are on the well
- Cement is left above the packer

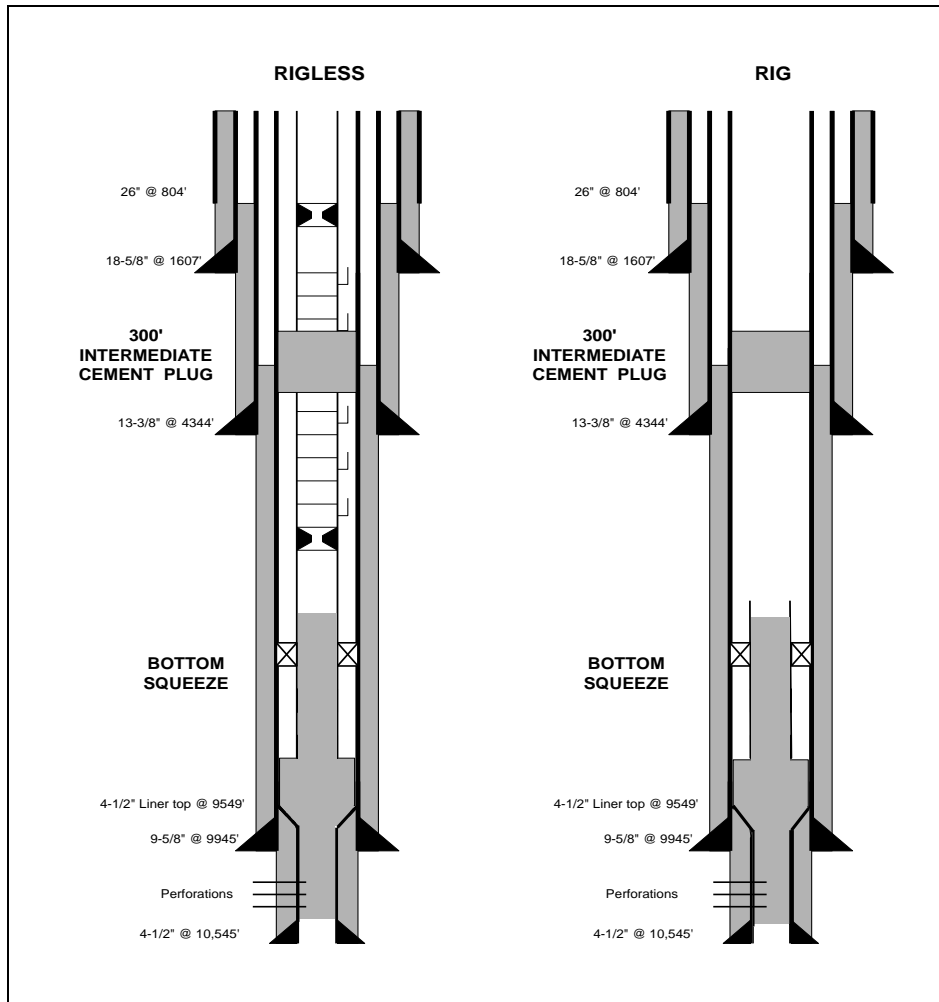

Figure 5-3. Balanced Plug on Rigless and Spotted Plug with the Rig

### Rigless

- Balanced cement plug is set in tubing and casing
- Tubing is left in well
- Tree is still on

### Rig

- Spotted plug is used
- Tubing is out of well
- Uses BOP's

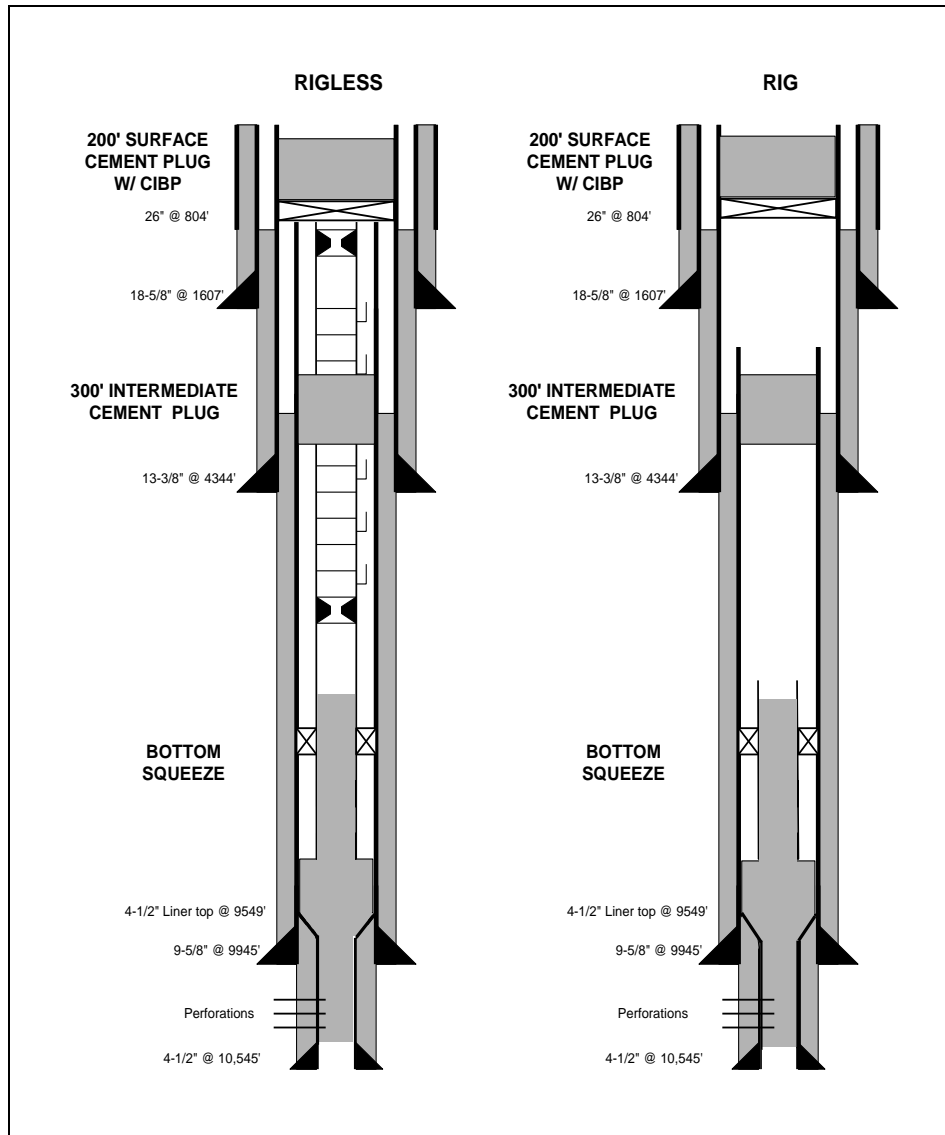

Figure 5-4. Rigless with Cut Casing and set CIBP; Rig with Same but with a little more Casing out of Hole

**Rigless**

- Casing is cut and pulled at 300' below the mudline
- CIBP is set
- 200' spotted cement plug on top

**Rig**

- More casing is cut and pulled usually above the surface casing
- CIBP is set
- 200' spotted cement plug on top

### 5.1.6. Current Innovations

The industry has recently introduced resin plugs in lieu of cement plugs for isolating well zones and sealing wells. Resin plugs have been proposed for improved gas migration control, specifically by reducing the formation of a micro-annulus between the plug and the pipe (see Figure 5-5). The resins in use are impermeable to gas and other fluids. The resin reaction is exothermic and the resin expands slightly during curing to pressurize the plug or to squeeze into voids. Some resins can be squeezed into micro-voids in cement. In addition to superior flow properties, resin plugs have over 200 times the tensile strength of cement plugs, have compressive strength greater than 8,000 psi, and form a 1,650 psi shear bond. Being less brittle than cement, the resin plugs do not shatter or crack when exposed to shocks from explosive charges.<sup>7</sup>



**Figure 5-5. Bubbling Well After Abandonment**  
(Photo courtesy of Professional Fluid Service, LLC)

### 5.1.7. Problem Wells

Problem wells may require additional or modified techniques to properly plug and abandon them. These additional or modified steps can increase the cost of well P&A.

- Collect and analyze well information.
- If the well was previously temporarily abandoned with cement or mechanical barriers, verify the present well condition by the operation and drilling reports. Gather previous cementing information from drilling reports to verify cementing of casings and annuli. Validate top of cement by cement bond log or calculate theoretically from cementing data.

---

<sup>7</sup> Professional Fluid Service, LLC press release

- Verify the condition of the wellhead and valves.
- Frozen valves may require hot tapping operations
- Bubbling (or leaking) wells due to sustained casing pressure shall require remediation procedures.
- Inadequate tubing or casing integrity (e.g., holes in the tubing, collapsed tubing or casing) may require additional plugging operations.
- Obstructions may require fishing operations via wireline or coil tubing.
- Obstructions or other well defects may require milling of cement plugs or downhole obstructions.
- Sand production or Paraffin buildup in tubing or casing may require cleaning out the wellbore.
- The presence of H<sub>2</sub>S or CO<sub>2</sub> in the well presents health risks to workers. Personnel need to be specially trained for dealing with H<sub>2</sub>S or CO<sub>2</sub> dangers and utilize proper PPE.

Problem wells increase P&A costs because normal operations may take longer, some additional procedures may be necessary, and some additional equipment may be needed. For example, a snubbing unit may be needed for wells that have sustained, high casing pressure. A hydraulic workover unit may be used to install or remove tubing in a dead well, i.e. a well with zero surface pressure and heavy fluid or mud in the wellbore. A coil tubing unit may be needed for fishing operations, cleaning sand or paraffin from the tubing, or pumping cement to seal collapsed tubing or casing. In some cases, problem well P&A may require a drilling rig and its associated costs.

## 5.2. Pipeline Decommissioning

### 5.2.1. Background

Pipeline decommissioning is the process of systematically removing a pipeline from service. Pipelines may be completely removed or, if allowed by local regulation, abandoned in-place. The more common practice is to obtain a waiver from BSEE or the governing entity to abandon in-place. When a pipeline is abandoned in-place, the line is disconnected or severed at each end, isolating the line and a portion of the line is removed in the area of the platform to which the pipeline is routed. The ends of the pipeline are plugged and buried to a depth of 3 feet or more. In instances where the pipeline is connected to a subsea tie-in, the pipeline is disconnected, a short portion of the line is removed and the valve connecting the pipeline being abandoned is blinded. When pipelines are decommissioned by removal, the entire pipeline is removed.

### 5.2.2. Data Retrieval

The first step in compiling pipeline data is developing an inventory of the affected pipelines by verifying the total number, name, and status of each pipeline originating and terminating on the platform. There are instances when the pipeline has been shut-in but not decommissioned. Knowing this information will help in the data search. Once the name and status of each pipeline has been established, create a file for each pipeline.

### 5.2.3. Review the Pipeline Files

The history of each pipeline is documented and it is up to the owner to know all about each pipeline.

The following documents should be included in the pipeline file:

- Copy of design criteria
- Copy of BSEE permit application
- Reproducible AFC structural drawings
- As-built route location drawing
- Copy of daily construction reports
- Date pipeline installed
- Date pipeline placed in service

### 5.2.4. Review Pipeline Agreements

A review of the pipeline agreements is necessary to establish ownership and liability responsibilities. The following information should be determined:

- Operator of pipeline(s)
- Abandonment responsibilities
- Ownership of pipeline
- DOT, DOI, or other regulatory agency responsibility
- Who is responsible for pipeline disconnect
- Who is responsible for equipment disconnect
- Ownership of equipment
- Notification contact & procedure
- Schedule restrictions
- Whether any pipelines need to be re-routed

### 5.2.5. Confirm Pipeline Information during the Field Inspection

An onsite inspection of the platform is necessary to confirm the pipeline information gathered. The field inspector, either a contractor or an employee of the owner, uses an inspection form and picture checklist. While inspecting the platform, the field inspector also looks for any additional onsite records, photos, and drawings of the following items:

- Pig launcher
- Pig Receiver
- Sales Unit
- Riser location
- Riser Configuration

The field inspector and the owner review all the data gathered during the data room search and field inspection. All the data is handed over to the Pipeline Abandonment specialist who then writes the permits, bid and evaluates the work.



## 5.2.6. Pipeline Preparation

Many of the activities necessary to abandon in-place are the same as those required to abandon by complete removal.

### 5.2.6.1. Notification

The project engineer will notify the owners of the trunkline that the company will be performing work on their trunkline. The owners of the trunkline may want to have an inspector on board to witness the work. In most cases, the inspector on board the barge will simply monitor the activities of the barge paying particular attention to anchor handling. The contractor performing the work should prepare a job letter in which he lays out his job plan. The job plan should include a section addressing safety and environmental considerations.

### 5.2.6.2. Install temporary pig launcher at the platform end of the pipeline

Naturally the assumption here is the Pipeline Abandonment work is to be completed before the platform is removed. In most cases the pipeline will have a permanent pig launcher on the platform. The riser on the pipeline should have been cut just above and just below the transition piece during the abandonment of the platform procedure removing approximately 10' of the riser. In cases where the abandonment of the platform has not been performed prior to Pipeline Abandonment, it is recommended that the pipeline riser be cut in two places as noted above and the temporary pig trap used. If it is necessary to cut the riser, first weld a 1" threadolet onto the riser and then drill a hole through the threadolet to drain any standing liquids which may be trapped in the riser. Any condensate or oil trapped in the pipeline will likely accumulate in the riser.

The pig(s) is run to purge the pipeline. A swabbing pig, which has the consistency of a heavy sponge, is adequate and minimizes the chance of a hang up when it is run. The scope of work should stipulate that the line is to be purged by running a pig(s) or by pumping 125% of the line volume in event the pig(s) is not recovered.

It should not be necessary to set the vessel up at the platform to run the pig. The vessel can be set up at the side tap. While the divers/ROV are locating the side tap and the pipeline is being lifted, a welder and a couple of hands can be placed on the tug to install the temporary pig launcher.

### 5.2.6.3. Locate the subsea connection of the pipeline

The line will typically be buried a minimum of 5' at the point at which it ties into the trunkline. Check the installation records of the pipeline which is being abandoned. There may be some information which indicates the depth the trunkline was buried when the line was laid.

Assuming no survey to verify the location of the tie-in point was undertaken prior to commencement of the work, it is sometimes prudent to provide a magnetometer or radiometer as equipment in the survey spread to help locate the pipeline tie-in point.

#### **5.2.6.4. Disconnect the line being decommissioned from the trunkline**

First close the side tap valve and loosen the bolts between the tap valve and the assembly. If there is no indication of a leak, remove the bolts and attempt to move the foreign pipeline. It may be necessary to remove clamps or other valves or fittings in order to be able to dislodge the line being abandoned from the connection to the trunkline. Avoid using cutting gear to cut bolts on the tap valve. Use bolt cutters or a mechanical saw. Damage to the tap valve could mean shutting in the trunkline. As soon as the foreign pipeline is removed from the tap valve, the tap valve is blinded.

#### **5.2.6.5. Raise the line which is being decommissioned**

After the line being decommissioned has been disconnected from the trunkline, it should be capped, plugged or blinded and then lifted to the surface. Any hydrocarbons in the line must be contained to prevent discharge to the surrounding water before the cap, plug or blind can be secured. Once the line has been lifted, the blind will be removed and a crossover fitting to a hose connection will be attached to the end of the pipeline. A hose will be attached and run to a storage tank.

#### **5.2.6.6. Run the pig from the platform end**

As soon as the line is lifted and turned to the storage tank, the line may be purged. The crew aboard the tug boat should have the pig ready to run by the time the line has been lifted and the hose connected. The line will be deemed purged once the pigs are received or 125% of the volume of the line has been pumped. Typically, water is injected after the first pig and this type of work may require more than one pig. The number of pigs depends on the removal needed of hydrocarbons liquid.

#### **5.2.7. Pipeline Abandonment**

If the pipeline is being abandoned in place, then after the pipeline has been flushed the ends are capped. At the platform, the riser is cut and removed. Each end of the pipeline is buried 3 feet. A typical practice it to leave the riser attached to the platform, as it will be removed with the jacket. If the riser is to be removed, depending upon the water depth, the riser may be disconnected by a crew working from a work boat or tug boat. Otherwise, the work vessel will pull up to the platform and remove the riser.

#### **5.2.8. Pipeline Removal**

When pipelines are decommissioned by removal, the entire pipeline is removed. Pipeline complete removal in federal waters is not typical, although in the Gulf of Thailand, estimates have been generated

for both removal and in-place methods. For countries where the federal water jurisdiction includes the shore line, a portion of the pipeline going to shore would need to be removed.

If the pipeline going to shore is directionally drilled into the seabed, the line would be severed seaward of the surf zone and plugged with the seaward end buried 3' or more BML by divers. A jetting barge and crane would jet and remove the pipeline.

If the pipeline route is buried onshore, the seaward end is severed and plugged as above and the line going to shore is removed to a water depth beyond which the barge can no longer travel. The shore end is unburied by a shore crew and equipment and the line is pulled ashore with winches. As the line is pulled ashore, it is severed in sections and placed on flatbed trucks for transport to a disposal facility.

### **5.2.9. Pipeline Removal from Floating Production System**

The pipelines (flow, export, lift, injection, umbilical, etc.) that are suspended from floating production systems present many removal challenges. The suspended part of the line is called a riser, the same as in fixed platforms. The line is fixed to the floating hull and anchored to the seabed by a piled in pipeline termination assembly. The riser must be inspected prior to removal in order to know if there are any integrity concerns. This information must be incorporated into the removal procedures to prevent any environmental or safety incidents.

New non-destructive inspection tools are now available that are helpful to plan for the removal of these flowline risers. Applus RTD UK Ltd has developed a subsea inspection system which is designed to ensure subsea equipment operational integrity. This system has integrated three technologies including ultrasonic phased array and time of flight diffraction (TOFD) techniques with alternating current field measurement (ACFM) which is an industry first.

Another subsea inspection technology is available from flexible pipe specialist Flexlife using its patented scanning technology (Figure 5-6). Flexlife has scanned numerous risers in the North Sea. Flexlife's ultrasonic scanning technology is the first to be able to successfully scan the annulus of flexible risers and flowlines in situ with 100% accuracy. The application can detect specific locations of any flooding and scan the armor wires around flexibles to an accuracy of 0.1mm. The tool is ROV-deployed and can operate down to 3,000 meters.

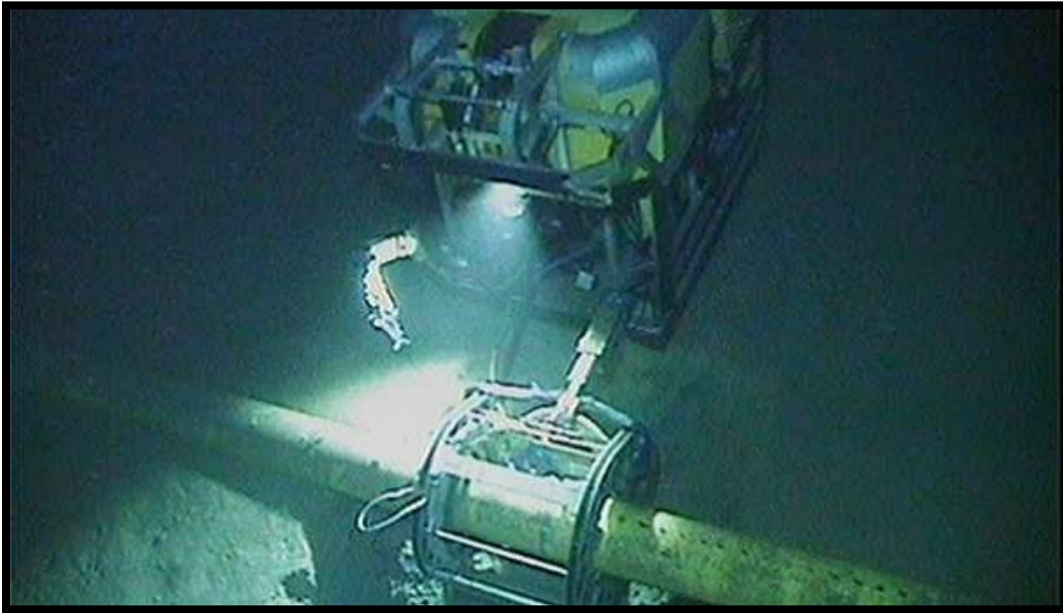

**Figure 5-6. Flexlife UT Riser Scanner  
(Photo courtesy of Flexlife)**

## 5.3. Platform Decommissioning

The same repertory of work gathering background information, complying with regulatory requirements and permitting as conducted for pipeline and well abandonment must be conducted for platform abandonment.

### 5.3.1. Platform Preparation and Cleaning

The main issue in this phase is to make sure that the platform is ready for the HLV, i.e., the drilling rig is removed if installed, modules are ready for removal, that there are no hydrocarbon fluids in the processing equipment, and the deck is ready for separation from the jacket.

Flushing crews with pumps and cleaning solutions set up on the deck and rig to the piping and equipment and flush the hydrocarbons either into processing equipment installed on the platform, through a pipeline to processing equipment on another platform, through filtering equipment brought by the flushing crew, or into holding tanks that are taken to a shore facility for cleaning. The workboat selected depends on the crew and equipment size and is usually a different per service provider. A general rule of thumb is to use a 180' class vessel.

If padeyes are not installed, lifting trunions or padeyes are prefabricated and installed during this phase. The padeye welds are examined by non-destructive examination methods.

All equipment to be removed has the welded connections removed and all connections between the deck and jacket are severed with the exception of the deck leg-to-jacket connection. The connections

may include piping, ladders, stairs, and electrical wiring. The crew will also verify that all pipelines are abandoned with a section removed near the +10 elevation (10 feet AWL) to visually verify that the pipeline is abandoned.

### 5.3.2. Conductor Severing and Removal

All conductors are completely removed at least 15 feet below the mudline. A combination of jacks and the platform's drilling rig and crane are used to pull the conductors. This work should be completed prior to the arrival of the heavy lift vessel (HLV). Removing conductors with jacks and a drilling rig generally follows the same methodology as removing conductors with jacks and a bullfrog crane. The jacks onboard may not be able to pull the combined weight if the conductor is grouted. The conductor is pulled upward until a 40-foot section is exposed. The rig is used until the jacks can pull the weight of the entire conductor. Each conductor is cut using external mechanical cutters or the threaded connections are unscrewed. The cut section is then removed by the drilling rig, platform crane or HLV and placed on the deck. The crane places the cut section on a workboat or cargo barge. This procedure (rig up, jack upward, cut and remove) is repeated until the entire conductor is removed. The HLV may place the cut section directly on the cargo barge.

### 5.3.3. Topsides Removal

During decommissioning, all decks must be removed. For fixed platforms, all decks must be removed offshore. Floating platforms may be towed to or near shore to have the deck removed, with the exception of MTLPs that must have the deck removed offshore, as the hull is not stable enough to support the deck when the hull is released from its mooring. All equipment, which has been installed on the deck after the deck was installed and that will significantly change the center of gravity, must be removed to a cargo barge prior to the deck removal.

Topside removal generally follows the installation process in reverse, with a similar type HLV. An exception to this would be for a larger deck that was installed in a single lift but can be separated into two smaller decks. The deck may be cut up into smaller sections (e.g., 8-leg cut into two 4-leg sections) as shown in Figure 5-7. The benefit of this is that a smaller HLV may be used. The HLV also needs to be sized to the lifting requirements of the planned the jacket removal. The HLV rigs to the deck padeyes, lifts the deck to a suitably sized cargo barge, and maintains tension on the deck until it is seafastened or secured to the cargo barge by welding. The cargo barge is rigged up with appropriate load spreaders for deck support as shown in Figure 5-8. The seafastening design is provided by the HLV operator, with or without input from the platform owner or operator.<sup>8</sup>

---

<sup>8</sup> Piece small and other unconventional methodologies were not within the scope of this study.



**Figure 5-7. Deck Severed into Lift Sections**



**Figure 5-8. Setting Deck for Seafastening**

All conductors are completely removed a minimum of 15 feet below the mudline. The conductors will typically be severed internally a minimum of 15' bml by explosives or abrasive cutting. A combination of Casing jacks, the platform's drilling rig if present, platform or portable crane or a HLV crane (or a combination thereof) are used to pull the conductors. For platforms in excess of 200' WD and especially for platforms with many conductors, it may be more economical to complete this work prior to the arrival of the HLV. Review during the planning stage will determine the method. Removing conductors with any method generally follows the same methodology. The conductor is pulled upward until a 40 foot section is exposed. The conductor is cut using external mechanical cutters or the threaded connections are unscrewed. The cut section is then removed by the crane and placed on the deck.

#### **5.3.4. Pile Severing and Removal**

The leg piles or skirt piles are typically severed internally at least 15' BML by explosives or abrasive cutting. Often a mudplug is formed during pile installation where mud is forced up into the pile above the mudline. This mud must be removed by jetting water under pressure inside the steel pile so that the plug is eroded and forced up and out the pile with the return water. If there is any pile internal obstruction, physical damage to the jacket leg or pile, or grout inside a skirt pile, then the piles must be severed externally by diamond wire cutting. This requires external jetting down below the cutting depth to set the diamond wire cutter.

If the piles must be removed from the jacket legs to reduce the jacket lift weight, the preferred severing method is abrasive cutting to eliminate beelling or flaring of the cut end, to allow the pile to be pulled through the bell guides. The HLV crane lifts the piles and places them on a cargo barge, where they are seafastened and transported to an onshore disposal facility. If the HLV's crane height is insufficient to pull the complete pile free of the jacket leg, the pile is pulled and removed in sections similar to conductor removal.

#### **5.3.5. Fixed Platform Jackets, Complete Removal**

If the HLV and cargo barge can handle the size and weight of the jacket in a single lift, the jacket is rigged, lifted, loaded onto the cargo barge, seafastened, and transported to the disposal scrap yard or reefing location. The HLV has to either rig to pre-installed padeyes, use pile or leg gripping tools, or rig to horizontal bracing that will support the weight lifted. Each lifting point requires a tool or rigging. A spreader frame can be used so that the HLV can handle multiple tools with the crane.

If the size and weight of the jacket exceed the capacities of the HLV or the cargo barges, the jacket is cut in sections and removed with multiple lifts. Removal in sections can be done either by cutting in place or by hopping.

Cutting in place involves sequentially removing sections of the jacket from the top to the base by making a series of cuts above or below the waterline. As each section is cut, it is lifted by the HLV and loaded onto a cargo barge. Cutting the jacket in-place requires the use of external cutting tools such as diamond

wire or external abrasive cutters. External cutting requires support from divers or remotely operated vehicles (ROVs) which increases costs and safety risks.

Hopping involves removing the portion of the jacket above the waterline, loading the cut section onto a barge, lifting the remaining jacket, towing the remaining jacket to shallower water, setting the jacket back on the seafloor in an upright position, and repeating the process until the last section of the jacket can be loaded onto a cargo barge. The jacket is rigged, lifted, and towed to shallow water for each horizontal cut. A spreader frame can be used so that the HLV can handle multiple tools with the crane. If the size and weight of the jacket exceed the capacities of the HLV or the cargo barges, the jacket is cut in sections and removed with multiple lifts. Removal in sections can be done either by cutting in place or by hopping.

Identifying where and how the jacket is cut impacts the jacket removal method. The jacket section dimensions determine the tow route and the depths at which the jacket must be placed to make subsequent horizontal cuts above the waterline. At all times the HLV should be holding the jacket. The method assumes that the jacket is cut above water with welders. This increases the welder's risk by working them outside a fixed environment, but this method is deemed far safer than cutting the jacket in-place.

A survey is conducted of the route along which the jacket will be towed and the locations where it will be set down on the seafloor. The jacket is towed to a pre-determined location that has the required water depth that allows the section above water to be cut. In addition, the seafloor in the selected location should be flat so that the jacket is level. HLV anchor mooring should be in place prior to commencing the decommissioning.

The size and number of required cargo barges depend on the number and dimensions of the cut jacket sections. In addition, the jacket has to be cut in such manner that the HLV and ultimately the onshore yard can handle the sections. Jacket sections must also be sturdy enough to make the sea voyage.

### **5.3.6. Fixed Platform Jackets, Partial Removal**

In partial removal, the upper section of the jacket is removed and the base remains in place. Selecting the optimum locations for the jacket cut points minimizes the onsite duration of the divers and the cutting tools. In the U.S., the depth at which the jacket is cut should provide a minimum clearance of 85 feet to avoid placing a permanent lighted buoy as required by the U.S. Coast Guard. Leaving the bottom part of the jacket in place is a form of reefing.

Toppling forces for each section must be calculated to confirm that the tugs selected have the capacity to topple the jacket. Another critical task is verifying that the cuts have been made. A diver or ROV should verify that each steel member is completely cut.



### 5.3.7. Fixed Platform Jackets, Remote Reefing

Remote Reefing requires several engineering analyses. A weight and buoyancy take-off should be calculated to determine the actual weight (jacket, internal piles, grout, marine growth, etc.) and buoyancy. These calculations show any additional buoyancy required and the proper placement of buoyancy bags or tanks to upend and tow the jacket.

Rigging and towing the jacket must also be planned for either towing by tugs or by an HLV. Padeyes are pre-welded to the jacket during the Platform Preparation phase.

The tow route should be selected during the engineering review. A bottom survey of the proposed tow route should be completed prior to removing the jacket. This survey will identify any obstructions on the sea floor that could hinder the safe towing of the jacket to the designated reef location.

### 5.3.8. Floating Platform Removal

Decommissioning floating platforms involves disconnecting the mooring system, removing the deck and hull and removing the mooring system. The topside can be cleaned onshore or offshore much the same way as for fixed platforms, with the exception that most floating platforms will have the capacity to process hydrocarbons from the flushed fluids and return clean water to the sea.

#### 5.3.8.1. Semis

For Semis, the deck can remain on the hull to be removed or refurbished onshore. Depending on the decommissioning engineering, two or more tow tugs are mobilized and rig to the hull. The mooring system is released to the seabed or rigging and/or a DP-HLV is mobilized to sever the moorings and either lower the moorings to the seabed or sever the mooring from the anchor piles with ROV severing tools and retrieve the moorings to a cargo barge. Ballasting and deballasting of the hull may or may not be necessary depending on the mooring design and removal method. The platform is towed to an onshore facility capable of handling refurbishment or scrapping.

#### 5.3.8.2. TLPs

TLPs are decommissioned similar to Semis, except the mooring system may be handled differently. If the mooring system is similar to the Semis it is decommissioned similarly. If the mooring system is steel pipe, the TLP is ballasted to relieve tension and the mooring system is severed from the mooring piles at the bottom with ROV cutting tool and severed at the top by either ROVs or surface cutting tools, depending if the upper connection is AWL or BWL. The platform is deballasted and removed similar to Semis.

#### 5.3.8.3. MTLP

MTLPs are decommissioned similar to TLPs, except that the platform hull design is not stable enough to support the deck without the mooring system. The deck is removed using an appropriate sized DP-HLV

and placed on a cargo barge and transported to a shore disposal site. The remainder of decommissioning is similar to TLPs.

#### 5.3.8.4. Spars

Spars are decommissioned by removing the deck and decommissioning the mooring system similar to Semis. The hull can be towed to a reef site, ballasted and placed on the seabed. If the hull is to be taken to a shore facility, the hull must be made buoyant to transport horizontally. To achieve this the ballast must be removed or buoyancy bags must be installed to overcome the ballast.

### 5.4. Subsea Structure Decommissioning

In addition to well plugging and abandonment with a drilling rig or a rigless equipment spread, the well P&A equipment can be set up on a specialized well intervention vessel. The industry has developed non-rig well abandonment techniques that utilize a purpose built service vessel. These well intervention vessels (WIV) are very cost effective in decommissioning subsea wells compared to using a drilling rig. These vessels use wireline or coiled tubing to access the wellbore. Vessels are available that can access and abandon subsea wells in water depths up to 10,000 feet. Motion compensation devices or constant tension winch packages are critical to the successful use of these vessels in deep water decommissioning projects. Prior to the development of these vessels operators used high day rate drilling rigs to abandon subsea wells.

If a purpose built well intervention vessel is unavailable a typical offshore supply and service vessel can be set up with well intervention equipment to perform the well decommissioning work. However the capabilities to perform well intervention are limited by the lifting capacity of the equipment and the weather capability of the deployment vessel.

### 5.5. Other Decommissioning Considerations

#### 5.5.1. Hurricane Damaged Structures

Hurricane damage to oil and gas facilities in the GOM, particularly after Hurricanes Katrina and Rita in 2005, complicated decommissioning operations at a number of platforms. Hurricane damaged structures, also known as “downers”, may require non-standard equipment and approaches to remove damaged components. Figure 5-9 and Figure 5-10 present illustrations of platforms toppled by Hurricane Katrina in 2005. Figure 5-11 and Figure 5-12 show platforms damaged by Hurricane Ike in 2008.

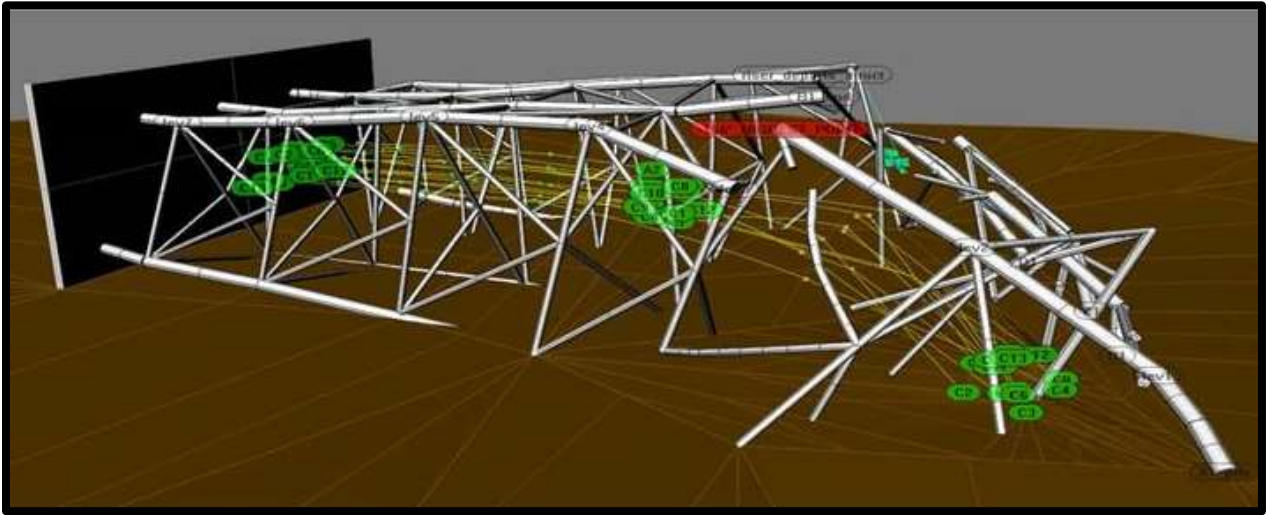

Figure 5-9. Typical Hurricane Katrina Damage, 2005

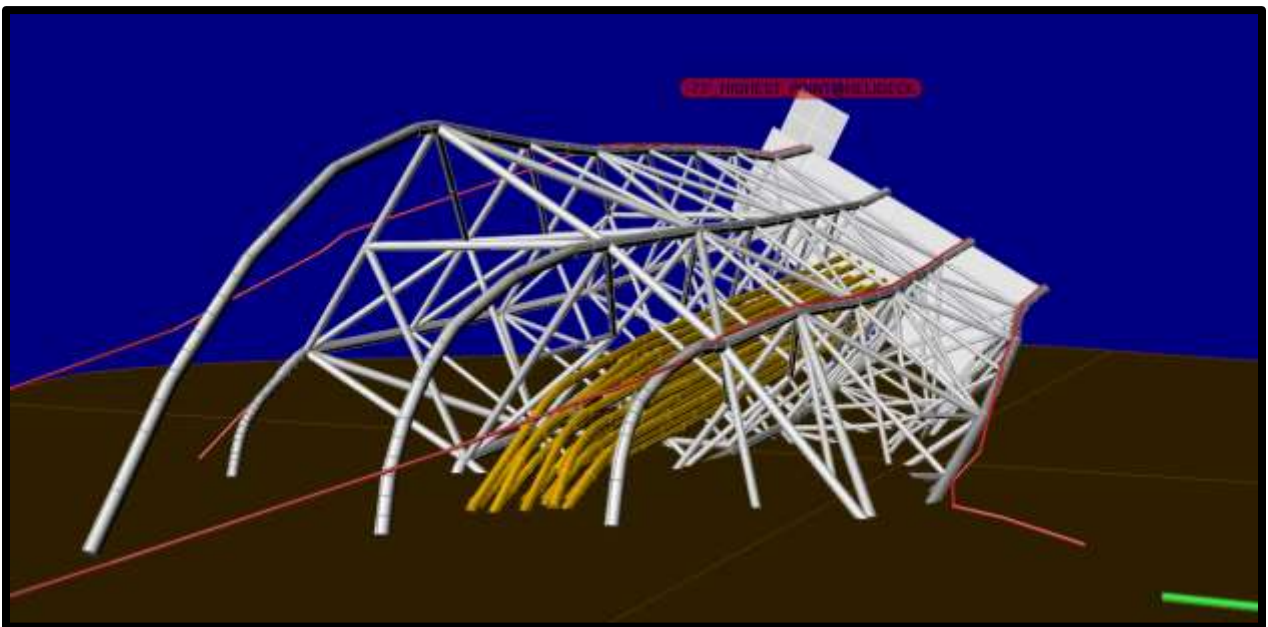

Figure 5-10. Hurricane Katrina Damage, 2005



Figure 5-11. Hurricane Ike Damaged Platform, 2008



Figure 5-12. Damaged Vermilion 281-A Platform, 2008

Weatherford recently completed a P&A operation for two wells on a hurricane-damaged platform in the GOM. In this case, a lift boat was equipped with a cantilever system to support an adjustable angled work deck that extended off the side of the lift boat and matched the 20° angle of the wells.

### 5.5.2. Reefing

According to the BSEE website, since 1986, approximately 470 platforms had been converted to permanent artificial reefs in the Gulf of Mexico (as of July 1, 2015). Many offshore platform jackets and jacket sections are placed in designated artificial reef locations in the Gulf of Mexico offshore Texas, Louisiana, Mississippi, Alabama and Florida. Permits are required for placing jackets in these locations by each state reefing commission, BSEE, the U.S. Coast Guard and the U.S. Army Corp of Engineers. These artificial reefs create underwater habitat for fish to increase fish populations for sport and commercial fishing and for numerous recreational diving ventures.

For fixed structures, the decks would normally be removed and taken to shore for disposal and the jackets would be candidates for possible reefing. Tethered and moored structures would normally be removed and transported to shore, except the hulls on Spar platforms may be considered as possible candidates for reefing. The reef site selected and approved must allow for an 85 foot or greater clearance from the top of the submerged structure to the water line for safe navigation.

After any wells and pipelines are decommissioned, the deck and any conductors are removed, piles are severed and the jacket is placed as a reef site by one of the following methods:

1. Reef in place (In-situ) by pulling over to lay horizontally on the seabed by the HLV or one or more pull tugs
2. Reef in place (In-situ) by severing the jacket at or below the -85 foot WD location and placing vertically or horizontally on the seabed by the HLV or one or more pull tugs
3. Reef in place (In-situ) by severing the jacket at or below the -85 foot WD location, placing the top jacket section on a cargo barge with a HLV. The top section is transport to shore for disposal and the bottom jacket section remains in place. Alternatively, the top section may be lifted, transported by the HLV to an alternate approved reef site and placed it on the seabed horizontally. In lieu of a HLV use, the jacket may be deballasted and towed to an alternate approved reef site where it is reballasted and sinks to the seafloor
4. A HLV lifts the entire jacket partly out of the water, transports it to an alternate approved reef site and places it on the seabed horizontally

### 5.6. Site Clearance/Verification

Site clearance involves identifying and removing debris on the seafloor. After removal of an offshore asset, the platform site and any temporary location where the jacket has been cut must be cleared of debris and verified that all debris has been cleared. In the U.S., platforms, single-well caissons, and well protectors located in water depths of less than 300 feet must have their locations trawled with 100 percent coverage in two directions (see 30 CFR 250.174) over numbered, and evenly spaced North-

South and East-West lines on a grid pattern by a trawling contractor who has no corporate or other financial ties to the company that performed the salvage work. The site is cleared using trawlers dragging nets across the bottom in a recorded grid pattern of specified coordinates (for a clear grid pattern) or by the use of other authorized methods using divers or surveys. Any trash that is retrieved from the sea floor needs to be properly disposed.

When a snag occurs, the exact location is calculated from the navigation data. This snag location and item is typically buoyed for further identification and removal. Each snag location is recorded and plotted and described on a final map. Each snag is recovered and the line associated with it is rerun. To ensure all snags are discovered regardless of the shapes and orientation, all of the even numbered lines are run in one direction and the odd numbered lines in the opposite direction. If debris is caught in the nets, it will be removed and stored on deck then transported for proper disposal ashore. A record of the line number on which it was retrieved is made with a full description of each item. Any sea-life encountered is returned to the waters.

Regulations require lessees or operators to clear all abandoned well and platform locations of all obstructions present as a result of oil and gas activities. For exploratory wells drilled with a Mobile Offshore Drilling Unit (MODU), the site is defined as a 300-foot-radius circle centered on the well. For single well caissons and well protectors, the site is a 600-foot-radius centered on the well. For platforms, the area covered by a 1,320-foot-radius circle from the platform's geometric center must be cleared.

Unless otherwise approved, site clearance and verification must be completed within 60 days after completing a platform or structure removal or abandonment operation. Trawling grid patterns (see Figure 5-13) must be as follows for the trawling equipment used:

- 40-foot grid pattern for vessels trawling with two 50- to 65-foot nets or four 30-foot nets.
- 60-foot grid pattern for vessels trawling with two 66- to 80-foot nets or four 31- to 40-foot nets.
- 80-foot grid pattern for vessels trawling with two 81-foot or larger nets or four 41-foot or larger nets.

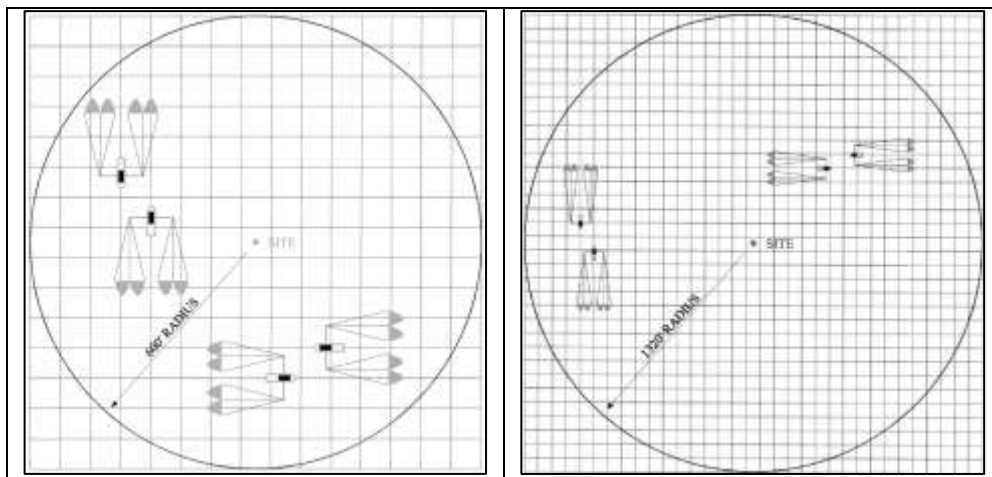

**Figure 5-13. Site Clearance and Verification Trawling Patterns**

An example of trashed collected during site clearance is shown in Figure 5-14.



**Figure 5-14 Example Scrap Pile from Site Clearance**

## 6. Decommissioning Technologies

This section presents additional details on recently developed or improved technologies related to well P&A, well intervention systems, cutting and severing, heavy lift vessels, and crew transfer technologies.

### 6.1. Well P&A

#### 6.1.1. Well P&A Spread Deck Layout

Figure 6-1 shows a typical layout of a rigless well P&A equipment spread. Spread size, composition and weights vary by service provider. Weights (WT) are in pounds.

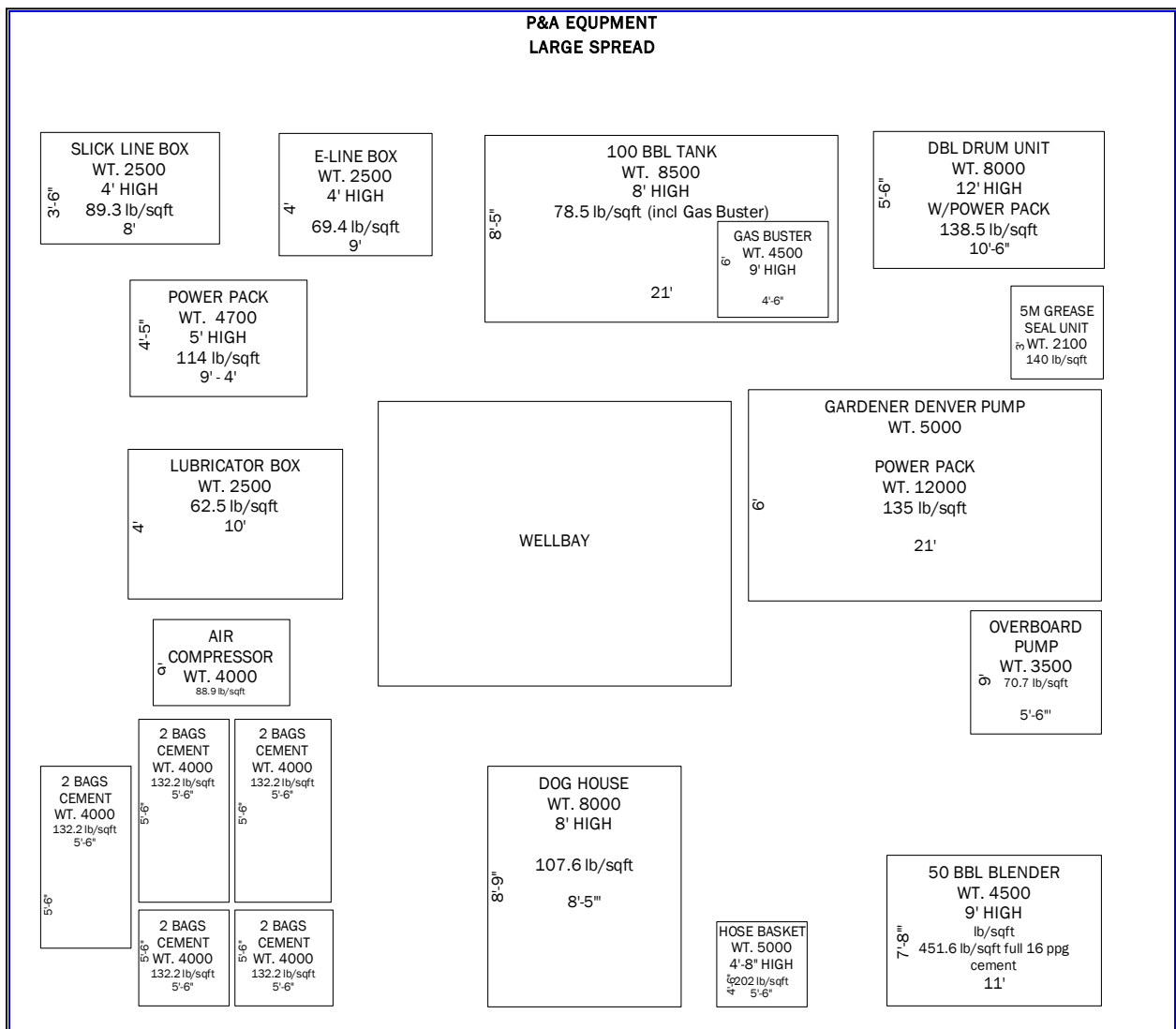

Figure 6-1. Sample Rigless Equipment Deck Layout



### 6.1.2. Well P&A Rigless Equipment

Figure 6-2 shows equipment for a typical rigless well P&A spread.



**Figure 6-2. Rigless Well P&A Spread**

The high pressure pump in Figure 6-3 is used to pump cement and other fluids at up to 15,000 psi and 6 bpm.



**Figure 6-3. Rigless Well P&A Pump**

Figure 6-4 shows a return tank used to capture fluids that are removed from the well bore. The fluids may include muds, seawater, or hydrocarbons. These are later processed for safe disposal.



**Figure 6-4. Rigless P&A Return Tank**

A cement blender is used to mix batches of cement for the cement plugs. The cement blender shown in Figure 6-5 has a capacity of 50 bbls.



**Figure 6-5. Well P&A Cement Blender**

In rigless P&A, wireline units are used in lieu of a drill rig to lower and raise tools, measurement instruments, or other equipment into and out of a well. The two basic types are slickline, which has a single strand cable usually less than 1/8" in diameter, and electric line, which has a multi-strand armored cable that protects an insulated electrical conductor. Double drum units, as shown in Figure 6-6, combine a slickline and an electric line in a single, space-saving unit.

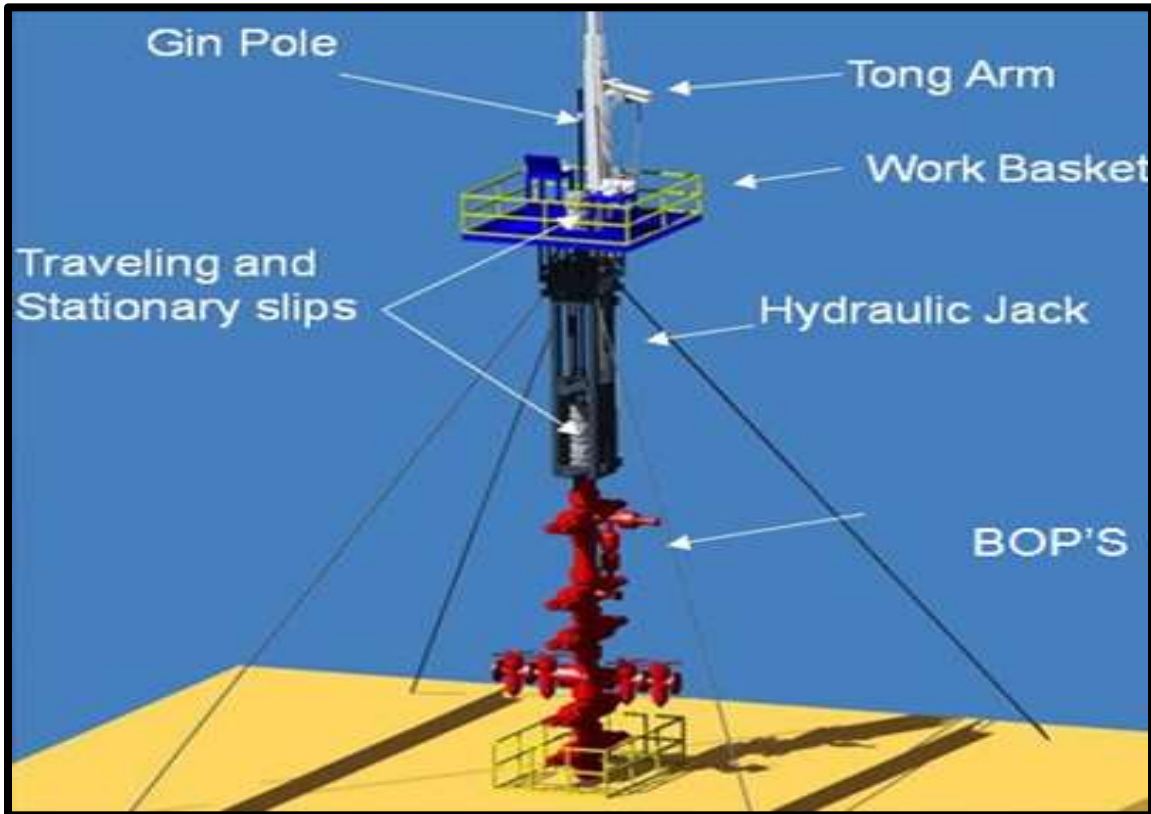

Figure 6-6. Double Drum Wireline Unit

### 6.1.3. Equipment for Problem Wells

When dealing with problem wells, the following additional equipment may be required for well plugging and abandonment.

Snubbing Units (Figure 6-7) are used primarily on wells that have sustained casing pressure to force tubing or casing into the pressurized wellbore. A snubbing unit incorporates a hydraulic jack to exert upward or downward force on the tubing while slip bowls guard against unwanted movement of the tubing due to imbalances between the weight of the pipe string and the fluid pressure.



**Figure 6-7. Snubbing Unit**

Hydraulic Workover is a well intervention technique used to install or remove tubular into or out of dead wells. A “dead well” is a well with zero surface pressure because it has a heavy fluid or mud in the wellbore or is otherwise not capable of sustaining natural flow. Hydraulic workover can be conducted for various operations such as well completion, abandonment, fishing and milling operations, and tubing or casing repair. Figure 6-8 shows a hydraulic workover unit.



**Figure 6-8. Hydraulic Workover Unit**

A Drilling Rig is commonly used for oil and gas drilling operations and can be used for well completion, production, and abandonment. The main components are draw-works, derrick, mud tank, mud pump, power source, BOPs, standpipe, pipe rack, drill string/bit, swivel, Kelly drive, and rotary table casing head or wellhead. Drill rigs for offshore wells can be self-contained mobile floating or jackup units, or can be permanent rigs installed on an offshore platform.

A Coil Tubing unit (Figure 6-9) is used in the well as a conduit for fishing operations, cleaning up sand from the tubing, cleaning paraffin buildup in the tubing, or pumping cement in the case of collapsed tubing or casing. Coil tubing typically varies in size from 1-1/4" to 3-1/2" in diameter.

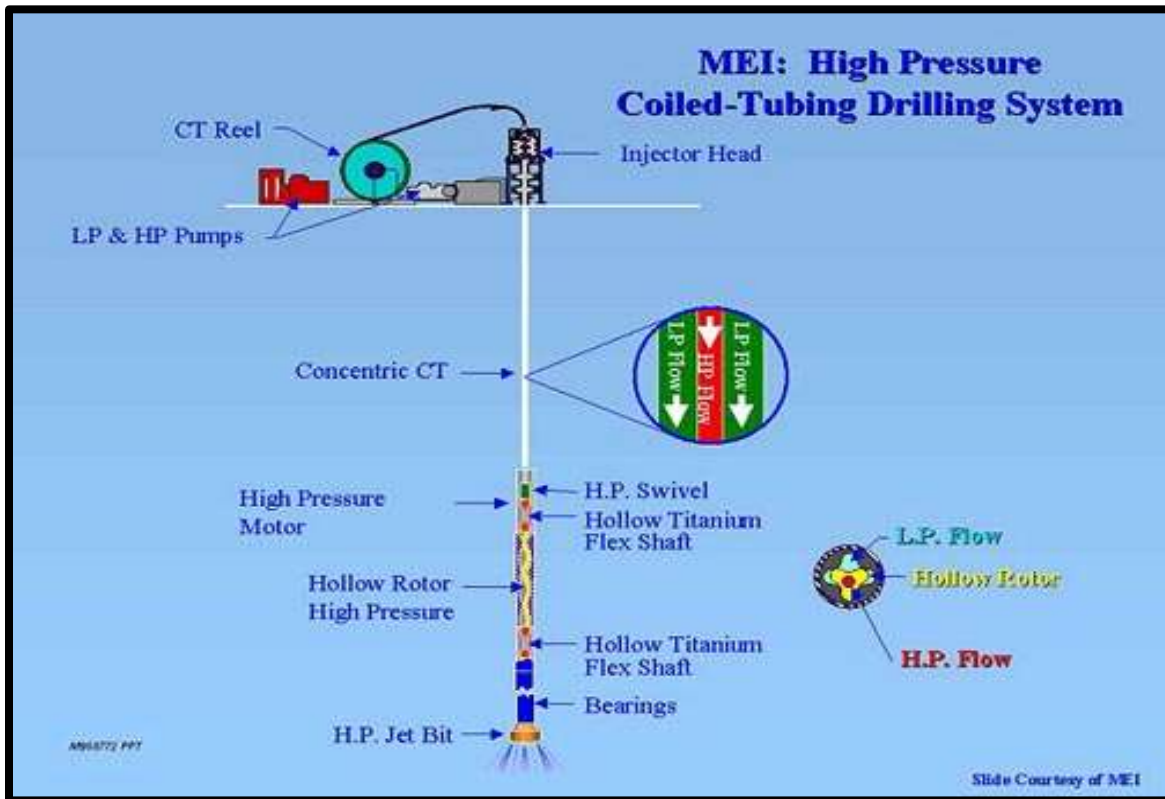

Figure 6-9. Coil Tubing Unit

Milling and Fishing encompass several type of operations, including milling cement plugs from tubing or casing, milling any kind of downhole obstructions, or section milling a casing window to remediate sustained casing pressure from annuli. This operation can be performed via coil tubing or a drilling rig.

## 6.2. Well Intervention Vessels and Systems

Figure 6-10 shows Helix's Well Ops Q4000 well intervention vessel. This vessel has performed well intervention work in 6,500 feet in the GOM. The vessel's ROV is rated to operate at 10,000 feet. The multipurpose vessel provides a stable platform for a wide variety of tasks, including subsea completion, decommissioning, and coiled tubing deployment.



**Figure 6-10. Q4000 Well Intervention Vessel**  
(Drawing courtesy of Helix Energy)

Another well intervention vessel, the Olympic Intervention IV (Figure 6-11), is chartered to Oceaneering International, Inc. The vessel is capable of subsea hardware installation such as umbilical's, subsea trees, jumpers, flying leads and manifolds. The vessel can also perform inspection, repair and maintenance (IRM) projects and is capable of well intervention services including riserless wireline, coiled tubing, electric line, and plug and abandonment operations.



**Figure 6-11. Oceaneering Well Intervention Vessel**  
(Photo courtesy of Oceaneering)

The AX-S system, developed by the Expro International Group, is a lightweight subsea wireline intervention system. The AX-S system, deployed from a vessel, can operate in depths up to 10,000 ft and can significantly reduce subsea intervention time. As a comparison, a typical deep water intervention can take 12 to 15 days using a rig, compared to eight to 10 days using AX-S (Figure 6-12). The AX-S System is able to perform well abandonment work on subsea wells.

The AX-S system is deployed onto a subsea tree from a mono hull vessel and is remotely controlled from the surface like an ROV. It consists of an integrated set of pressure-contained subsea packages comprising a well control package (WCP), a tool storage package, a wireline winch package, and a fluid management package. A hydraulic plug-pulling tool overcomes the risks associated with pulling and setting tree crown plugs. The system has a fully enclosed pressure housing, with no dynamic seals between the wellbore and surrounding environments. The WCP is a dual safety barrier containing industry-proven 7 3/8-in. shear seal and gate valves. If any safety issues arise, the operator has time to identify the problem and isolate the wellbore.

The tools are swapped on the seabed in minutes, and because they are held in a pressure-retained housing, no pressure testing is required after each tool change, saving operations time. The tools are run in the well by the wireline winch package which is also contained within the pressure housing. The winch has 25,000 ft (7,620 m) of electric line to convey the intervention tools into the well.

The fluid management package can deploy glycol fluid into the system to flush out seawater and hydrocarbons that are then circulated back into the well or back to the host subsea production system. Seawater can also be mixed with the glycol in variable ratios for pressure testing and flushing.





**Figure 6-12. Expro Group AX-S Subsea Well Intervention System**  
(Photo courtesy of Expro)

## 6.3. Cutting and Severing

### 6.3.1. Explosive Methods

Explosives have been used for cutting and severing in many offshore decommissioning projects. The Gulf of Mexico has been the worldwide proving ground for platform removals. Explosive severing methods were used on 67% of platform removals between 1995 and 2005. Figure 6-13 shows a subsea template that was severed with explosives.

Explosives are widely used to decommission platforms because they are safe, reliable, and cost effective. The use of explosives reduces the amount of time divers are used during the cutting process, thereby minimizing human risk. Additionally, the cost of severing piles and conductors is generally less than 1% of the total platform removal cost. Time is the driving cost factor when discussing severance; delays in vessel spreads are the primary reason for cost overruns. A failure in the complete severance of a pile or conductor is usually charged to the owner of the platform. These costs can be enormous, as time and material rates for large crane vessels can exceed \$500,000 dollars per day. The disadvantage of using explosive is the possible delays and cost associated with marine mammal or turtle sightings.



**Figure 6-13. Template removal by explosives**  
(Photo courtesy of Demex International)

The size and weight of a charge can affect the cost of placing the charge, especially in deep water. The cost for placing charges that weigh under 100 pounds does not significantly change because these charges are lowered with inexpensive rope. The detonating cord is also a minimal cost component. Setting a standard Shock Wave Enhancement Device (SWED) device weighing less than 600 pounds only requires a ¼-inch wire cable. However, the SWED devices are constructed with large-diameter plates in varying thickness. As plate diameter and thickness increases, costs escalate due to difficulties in machining and handling the device. Plate diameters over 6 feet are considered special order and require a long lead-time. Heavier charges required to sever larger piles require larger cable, and increasing the cable diameter to over 1 inch can have a significant effect on the overall cost.

Many variables can dramatically increase the cost of shaped charges. Nevertheless, of all the uses of explosives, the shaped charge has developed the most scientific and practical applications. Shaped charges can be used as precision devices.

#### **6.3.1.1. Explosive Charge Types**

Available explosive methods are bulk charges, configured bulk charges, and shaped charges. Remotely operated vehicles (ROVs), dynamically positioned vessels, wire line units, and detonation of multiple charges with delays enhance the effectiveness of explosives.

Halliburton has developed newer, novel cutting technology and techniques which significantly reduce the quantity of explosive material required for certain cutting situations, particularly thicker wall tubular members.

### 6.3.1.2. Bulk Charges

Bulk charges are a single mass of explosive material detonated at a single point. The energy release from this type of charge is not well directed. Rather, bulk charges rely on the “brute strength” of the explosive to overcome the target material by a shattering and tearing effect.

Bulk charges are cylindrical in design as shown in Figure 6-14. These charges vary in length and diameter to achieve the best fit for a wide range of typical offshore tubulars. Charge diameters range in size from 4” to 12”.

Smaller bulk charges can be arranged to create a larger diameter. This technique allows the technician to configure the cast explosive material for whatever conditions may arise. For instance, in some cases it might be advisable to use smaller charges in a circular ring configuration to maximize the explosive concentration and proximity to the target material. .



Figure 6-14. Bulk Charges

### 6.3.1.3. Double-Detonation Bulk Charges

The use of a double-detonation bulk charge creates more "cutting power" pound-for-pound than an ordinary bulk charge. Double detonating the bulk charge is accomplished by using instant non-electric detonators at opposite ends of the charge. This detonation creates a confluence of energy at the center

of the charge, which is dissipated radially outward directly perpendicular into the target material. It is this directing of explosive energy that makes double-detonating bulk charges more effective.

#### **6.3.1.4. Shock Wave Enhancement/Centralizing Devices**

The shock wave enhancement device (SWED) combines the best features of bulk charges with the added benefit of extreme confinement. A bulk charge is used with a metal and/or concrete plug above the charge. Centralizers are used to distribute the explosive energy evenly throughout the target area. The energy released by a bulk charge can be enhanced by the use of tamping or confinement. The addition of this tamping increases the duration of the impulse that is released by the explosive towards the target material. Using increased confinement, multiple-point detonation, and the actual water inside of the tubular to direct energy; this device is the most reliable bulk explosive severance device available to date.

#### **6.3.1.5. Shaped Charges**

The most efficient use of explosives for severing is the shaped charge. The shaped charge uses the energy produced by the detonation to drive a liner at high velocity at the target. The liner striking the pipe wall at this accelerated velocity then cuts the target.

Shaped charges have a multitude of manufacturing and design criteria that can drastically affect performance. The design criterion for shaped charges also requires knowledge of target specifications. Manufacturing of shaped charges can take many weeks and can cost five times as much as conventional bulk charges.



**Figure 6-15. Shaped Charges**

Conical, rotationally symmetrical charges (Figure 6-15) produce the greatest penetration of all shaped charges due to the 360 degrees of radial convergence forming the jet. Variation in the conical liner angle will result in varying properties of the jet. A small angle will produce a very small, deeply penetrating jet, while a large angle will produce a larger hole with shallower penetration.

A running linear charge (Figure 6-16) is a roof-shaped liner of a given length used to cut plates or sheets of metals or other materials. The horizontal velocity of the detonation contributes to its penetrating effectiveness. It normally comes sheathed in lead in a coil form and can be produced in any desired length.

A simple cutting charge (or non-running linear charge) has a roof-shaped liner two- to three-times the liner width. The lower horizontal detonation velocity decreases the cutting effectiveness in this configuration. This charge has much more explosive above the liner for the increased power required to cut and to provide a more uniform, flat detonation wave.



**Figure 6-16. Linear Charge**  
(Photo courtesy of EBAD)

A planar, symmetric, conical charge is a regular rotationally symmetric shaped charge modified to cut in a linear fashion by adding massive confinement. The two opposite sides parallel to the central axis have 90 degrees of heavy steel plating affixed to the outside of the charge. This results in uneven collapse of the liner and a fan shape jet toward the target, producing a slit instead of a round hole.

#### **6.3.1.6. Deep water Issues**

Explosives have been used in deep water in a variety of applications. Primarily, the work conducted relative to offshore structures has been for wells. Conductor wells have been successfully severed in water depths exceeding 2,850 feet. Explosive charges have been set using divers, remotely operated vehicles (ROVs), atmospheric diving systems (ADSs), and off the end of drill pipes from drilling vessels with the aid of underwater cameras.

Pile jetting is necessary in order to place the explosive device inside the pile 20 feet below the mudline. In deep water this presents a challenge due to hydrostatic pressures encountered during the jetting operation. Techniques will have to be developed to accomplish this jetting if the jacket is completely removed. An alternative solution though more expensive would be excavating around the pile to provide access for severing the pile externally.

#### **6.3.1.7. Effect of Water Depth on Explosives and System Selection**

The explosive selected for deep water applications must be one which is not desensitized by water; does not have components that separate under pressure, and does not become more sensitive with the expected increase in hydrostatic pressure. This rules out many of the binary explosive mixtures and blasting gels.

It may become necessary to place the detonator underwater. Most common detonators are not designed for use in water depths over 400 feet; however, seismic detonators can withstand depths of 5,000 feet or more. Factors to consider in detonator selection are:

- Metal shell material, diameter, and wall thickness (i.e., will the hydrostatic pressure crush the detonator?)
- Method of sealing around the wires going into the detonator (i.e., will water be forced into the detonator housing, thereby desensitizing the initiating explosive?).
- In the case of non-electric detonators, the housing seal as well as the pressure rating of the shock tube are factors limiting most non-electric detonators to a maximum of 270 feet.
- Only electrical detonators with resistors should be used. With non-resistor electrical detonators, galvanic current from anodic jacket protection could trigger an unplanned detonation.

There are a number of initiation systems used, depending on the detonator type. These include:

- Common electric detonators can be initiated at the surface by almost any electrical means. This requires connecting two-conductor wires from the detonator to the place of initiation.
- Both remote and acoustical firing systems are available for electric detonators. In this type of initiation system, limiting factors are the distance from the detonator to the receiver and the distance between the receiver and the transmitter. System costs and deployment methods are problems with the acoustic system.
- Exploding bridge wire (EBW) systems require a firing module and a control unit. The maximum distance between the firing module and the EBW detonator is 300 feet; the maximum distance between the firing module and the control unit is 3,000 feet.
- Programmable detonators are now available for explosive use.

#### **6.3.1.8. General Cost Estimating Assumptions**

Deriving applicable cost matrixes for platform removals using explosives is difficult due to the high number of variables involved. The following assumptions are generally made in order to properly analyze when estimating the cost of the use of explosives to sever piles during the removal process:

- Government weight restrictions are not a consideration for the explosive charges.
- Explosive charge weights are presented in a range, low to high.
- The cost of backup charges is not included in this study.
- Pipelines in the vicinity are not considered.
- National Marine Fisheries Service (NMFS) procedures will be followed.
- All government permits will be obtained.
- All explosive charges will be set internally to the piles.
- For the main piles, the deck will be removed or full access to piles otherwise obtained.
- Damaged stabbing guides are not considered.
- The explosive charges will not be set inside the stabbing guides.
- All piles will be jetted to at least 20' below the mud line.

- All piles will be gauged with a “dummy” charge of the same dimensions as the explosive charge.
- A crane or some other suitable means will be used to set the explosive charges.
- Total explosive charge weights will range between 6,000 and 12,000 pounds, which will require wire rope diameter to be between ¾ inches to 1-1/8 inches.
- Explosive charges will not be left in piles for over 1 week.
- Adequate time for manufacturing of charges and mobilization are not considered.
- Safety is the number-one priority.

### 6.3.2. Non-Explosive Methods

Non-explosive methods presently used include diamond wire, guillotine saws, abrasive (slurry) cutters, mechanical cutters, and oxy-arc torch (diver cutting).

#### 6.3.2.1. Diamond Wire Cutting System

The diamond wire cutting system (DWCS) shown in Figure 6-17 and Figure 6-18 is an external cutting tool that can be used to cut jacket legs, piles, and diagonal members above and under water. Divers or a remotely operated vehicle (ROV) can install the DWCS. The DWCS consists of a structural steel clamping unit and a diamond wire cutter. The frame is designed to clamp on the member being cut. The cutting wire consists of a steel wire rope with a diameter of approximately ¼-inch onto which is threaded a series of steel rings approximately ¼-inch long. These rings are embedded with diamonds, and are separated by a spacer sleeve that places the rings 1-inch apart.



**Figure 6-17. Diamond Wire Cutting System**

The cutting system is designed to allow the wire to rotate along the perimeter of the frame. The wire rotates about the pulley wheels. A ROV can be used to set the leg clamp and cutter in the proper



position on the member to be cut. Once installed, the DWCS's wire speed, working pressure, and flow rate is controlled from the surface.

Diamond wire cutting has been used since the early 1990's in the North, Adriatic, and Red Seas. Since then, the DWCS has been used for the removal of offshore platforms, caissons, conductors, risers, etc. It has been used in the GOM to externally cut 82" and 48" caissons installed in 120 feet of water. Cutting times were approximately 20 and 2.5 hours for the 82" and 48" caissons respectively.

The DWCS has many possible uses for deep water platform decommissioning. The cutting system can be used to sever large platform legs and piles while divers sever the diagonal members. An ROV can be fitted with the cutting tool and sent down to cut the diagonal members at depths where divers cannot work safely. The same ROV configuration can be used to cut the pipeline ends.

Benefits of this cutting tool over other cutting methods are many. There seems to be no limitation in the size of the cut or material to cut, as long as the cutting tool can be fixed to the cut member. Water depth may not be an issue when using this tool; an ROV or diver wearing a hard suit can take and set the tool at the desired location. By-products generated by the DWCS are only the fine cuttings from the object being cut, minimizing impacts to the environment.

Limitations of the DWCS are based on its external cutting design. If piles are to be severed below the mudline, jetting or excavation needs to be performed to allow the cutting device and frame to be attached to the pile. Additional jetting may be necessary depending on the size of the ROV or other subsea device being used to attach the unit. An additional limitation of the DWCS is its current control system.

Developments, currently underway, promise to overcome the limitations in the DWCS's present design. A sub-bottom cutter (SBC) is currently in development, which will facilitate cuts below the mudline. Additionally, a computerized cutting control system promises to provide faster cuts that are more successful in the near future.



**Figure 6-18. ROV Diamond Wire Tool**

### **6.3.2.2. Guillotine Saw**

A guillotine saw (see Figure 6-19) is a hydraulically, electrically or pneumatically operated saw with a single blade that motions side to side, in the same way a basic hack saw operates, and is progressed forward by a simple worm gear mechanism through the material. The guillotine saw cutting system operates in a similar way to the diamond wire saw in that it can be operated from an ROV hydraulic power pack for deeper water operations or set by a diver in shallow water. As this is an external cutting method site clearance to 20ft below mud line is also required.

The clamping mechanism is similar to that of the DWCS but guillotine saws are currently limited to cutting members with a maximum diameter of 32". Anything larger is considered too bulky as the magnitude of the side to side motion performed by the saw during the cutting operation increases considerably. The maximum size is also limited by the length of the single blade, which can be prone to snapping if too long.

Traditionally the industry has elected to use diamond wire saws for large diameter cuts.

The benefit in using the guillotine saw is that the consumables (i.e. the blade) is very inexpensive in comparison to a diamond wire "loop" and is as easy to replace if broken.



**Figure 6-19. Guillotine Saw**  
(Courtesy of EH Wachs)

### 6.3.2.3. Abrasive Cutter

Abrasive cutting employs mechanisms that inject cutting materials into a water jet and abrasively wear away steel. There are two types presently in use: high volume-low pressure and low volume-high pressure systems. The first type disperses high volumes of sand or slag mixed with water and delivers 80 to 100 gallons/minute at relatively low pressure, 4,000 to 10,000 psi. A newly developed 15,000 psi system is available which is useful for multistring conductor cutting and can be adapted for other cutting applications.

An internal abrasive cutter (Figure 6-20 and Figure 6-21) is spooled into an open pile to 15 feet below the mudline, after jetting out the mud plug to 20 feet below the mudline. Once the unit is in position, the centralizer arms are extended. The mixing units and pump are then started. Water is pressurized and forced through a hair-thin opening, producing a powerful water jet stream. Small particles of abrasive are added to the high velocity jet stream and the cutting begins.



Figure 6-20. Water abrasive Cutting c/w internal manipulators

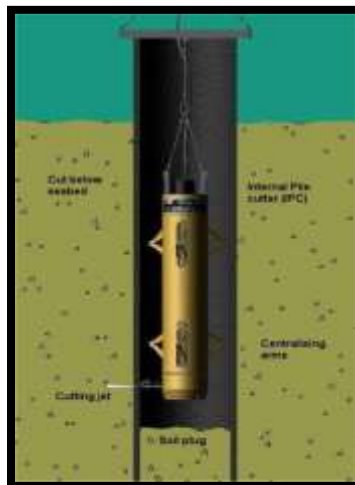

Figure 6-21. Water Abrasive Cutting

The external abrasive cutting tool works on the same principle as the internal tool. Using the same feeding system, the external abrasive cutter is attached using a series of tracks that wrap around the member to be severed. This system must be attached by a diver, which limits the depth at which this system can be used safely.

Limitations for both the internal and external abrasive cutters include uneven cutting and water depth limits. Limitations also include the minimum inside diameter of approximately 7 inches that can be accessed and the maximum outside diameter that can be cut. In shallow water depths, abrasive cutters have been proven to be an effective alternative to explosive pile severing. In some circumstances, conversations with abrasive jet contractors reveal the unsatisfactory use of these cutters in water depths greater than 600 feet. Improvements to the systems will eventually allow the abrasive cutters to work in deeper water depths.

There also exists the problem of verifying that the cut has been made when using an internal abrasive cutter. Unlike explosives, the conductor or pile often does not drop, confirming that the cut was successful. With an abrasive tool, the width of the cut is small and combined with the soil friction, a visual response generally does not occur. To verify the cut, the conductor is pulled with either the platform crane or hydraulic jacks. The lift force must overcome the conductor weight and the soil friction. At times, this force is many times more than the actual conductor weight. It is generally assumed that the cut is not successful if the conductor cannot be lifted with a force two times the conductor weight. The abrasive cutting tool is either re-deployed to make another complete run, or explosives are used to complete the cut.

Recent improvements in abrasive cutting technology have enabled development of a wellhead retrieval internal multi string cutting tool.

#### 6.3.2.4. Power Shear

Mechanical cuts can be made with hydraulic power shears (Figure 6-22). These mechanical shears use hydraulic pressure to close metal jaws with enough force to cut through jacket structural members.

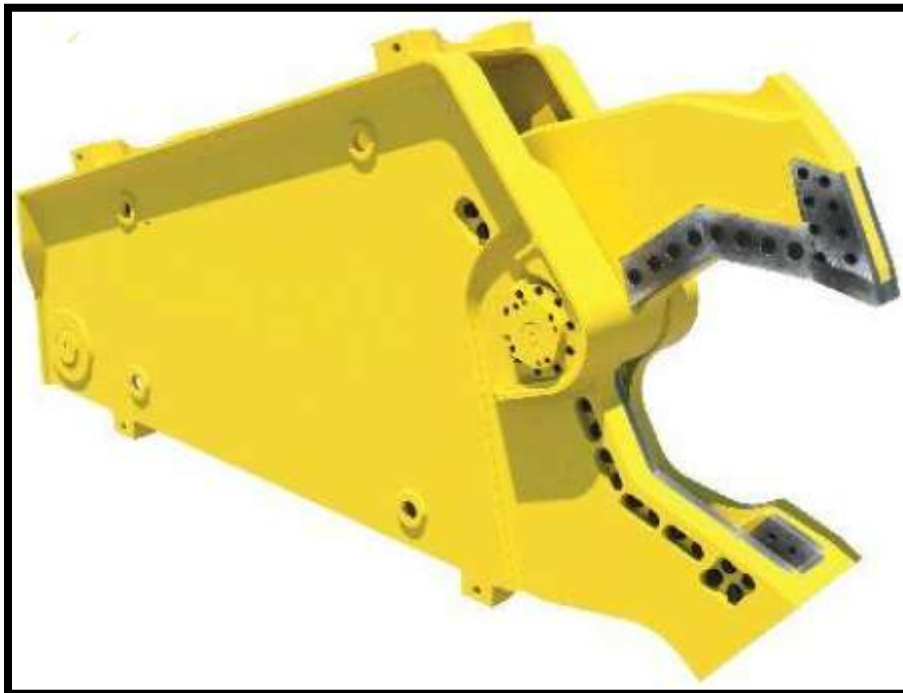

**Figure 6-22. Hydraulic Mechanical Shear**

Above water and underwater cutting technology with remotely controlled self-contained power shears has seen limited use in the offshore sector. This technology has recently been developed from bridge pile demolition. This equipment requires a skid mounted power source, cutting unit(s) and one technician. Cutters have been developed capable of severing up to 48" diameter multi-string conductors both above and below the waterline.

Figure 6-23 shows a 16 inch diameter pipeline with a ½ inch wall thickness and 1¼ inch concrete and rubber epoxy external protection being severed with a power shear after removal. The pipe was cut into 40 ft sections for transport. Each cut took only 11 seconds.



**Figure 6-23. Pipeline Cut with Power Shear**  
(Photo courtesy of Prime Marine Services, Inc.)

Cuts below the mudline have a depth limitation because of the difficulty in dredging space around the target member for the power shear's large footprint. Cuts have been successful up to 8' below the mudline (see Figure 6-24).



**Figure 6-24. Multi-string Conductor Sheared below the Mudline**  
(Photo courtesy of Prime Marine Services, Inc.)

The versatility of the power shear cutters has led to their increased use both offshore and for onshore demolition of jackets (Figure 6-25) and decks (Figure 6-26).



**Figure 6-25. Power Shear Cutting Platform Jacket**  
(Photo courtesy of Prime Marine Services, Inc.)



**Figure 6-26. Power Shear Cutting Platform Deck Beam**  
(Photo courtesy of Prime Marine Services, Inc.)

#### 6.3.2.5. Rotary Mechanical Cutter

Rotary mechanical cutting employs hydraulically actuated carbide-tipped tungsten blades to mill through tubular structures. This method has been used most successfully on small-diameter caissons with individual wells and shallow water well-protector platforms with vertical piles.

Figure 6-27 illustrates how an internal mechanical cutting tool lowered into an open pile. The power swivel is supported and connected to the top of the pile. The power swivel turns the drill string so that the milling blades are forced outward hydraulically to cut the pile or well; centralizers on the tool keep it concentric inside the pile or well.

Limitations for the mechanical cutter include uneven cutting (from lateral movement of uncemented strings), replacement of worn blades, larger lifting equipment necessary to set the system, and more time required to make each cut.

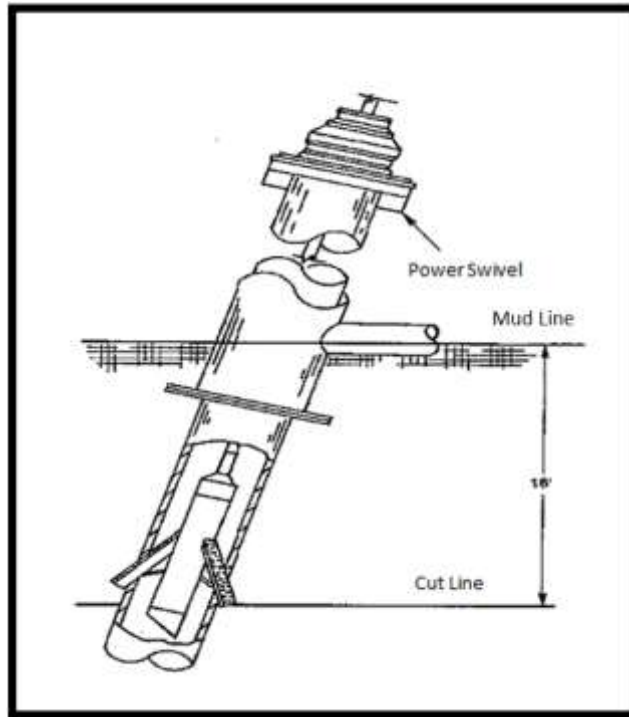

Figure 6-27. Mechanical Cutting Tool

#### 6.3.2.6. Carbon Tungsten Beaded Wire Cutter

Versabar has developed a carbon tungsten beaded wire cutting system that can sever 15' BML. A 2½ inch cutting wire is brought to bear against the member to be cut. Figure 6-28 shows a caisson and grouted conductors cut and removed with this system.



Figure 6-28. Grouted Caisson Severed with Tungsten Beaded Wire



(Photo courtesy of Versabar)

### 6.3.3. Cutting and Severing Conclusions

Several cutting techniques were reviewed in this section. Explosives are predictable, flexible, and reliable. Current industry practice primarily utilizes explosives to sever piles below the mudline at any water depth.

Abrasive and mechanical cutters are not as reliable as explosives to sever piles. Although they have been proven effective (generally on platforms located in relatively shallow water), deep water simulation tests have demonstrated that there are a number of operational issues that need to be resolved for each of these alternative cutting methods. Additionally, there are more delays with these systems if they fail, and a complete cut during the first pass is less likely to occur than if explosives are used.

The DWCS is an alternative cutting tool that has great potential for deep water use, specifically for severing jackets and pipelines. It is relatively easy to install (diver- and ROV-friendly) and current frame designs fit the pile sizes associated with most platforms. Although the DWCS might soon become a standard tool for efficiently severing piles, conductors, and pipelines, further testing is necessary before it can be considered a viable alternative cutting method for deep water platform removals.

While these alternatives may provide a viable alternative to explosive pile severing, potential increases in cost and diver risk currently make these alternatives less attractive than explosives for the removal of deep facilities.

## 6.4. Heavy Lift Technologies

### 6.4.1. Heavy Lift Vessels

The load weights associated with deep water fixed and floating platform installations limit the number of heavy lift vessels (HLVs) that have the capacity to remove these facilities. The need for larger HLVs is apparent as industry is installing more production facilities in deeper waters. Included are brief descriptions of each of these technologies, and an assessment of the potential to apply them to the removal of deep water platforms.

A limited selection of heavy lift vessels (HLVs) working around the world today can perform the tasks required for removing deep water platforms. As of November 2014, there were 107 heavy-lift vessels in the worldwide fleet with 100 short ton (91 metric ton) capacity or greater, according to Offshore

Magazine's 2014 Worldwide Survey of Heavy Lift Vessels<sup>9</sup>. Table 6-1 lists the HLVs with lifting capabilities of 2,000 st or more.

**Table 6-1. Heavy Lift Vessels**

Largest Crane Vessels			
Vessel	Company	Capacity (mT)	Type
Pioneering Spirit	Allseas	Topside – 48,000; Jacket – 25,000	Twin Hull
TML	SeaMetric	20000	Twin vessels
Thialf	Heerema	14200 (2 * 7100 tons)	Semi
Saipem 7000	Saipem	14000 (2 * 7000 tons)	Semi
Bottom Feeder	Versabar	10000	Dual Barges
Svanen	Ballast Nedam	8800	Catamaran
Hermod	Heerema	8165 (1 * 4536, 1 * 3629)	Semi
7500 Barge	ZPMC	8500	Monohull
Balder	Heerema	6350 (1 * 3629, 1 * 2722)	Semi
Borealis	Nordic	5000	Monohull
Oleg Strashnov	Seaway	5000	Monohull
Bottom Feeder	Versabar	4000	Twin barges
DB 50	J. Ray	3992	Monohull
Rambiz	Scaldis	3300	Catamaran
Asian Hercules II	Smit	3200	Monohull
DB 101	J. Ray	3185	Semi
DB 30	J. Ray	2800	Monohull
Sapura 3000	Acergy	2800	Monohull
Stanislav Yudin	Seaway	2500	Monohull

Figure 6-29 shows two representative heavy lift vessels.

<sup>9</sup> Moon, Ted, "2014 Worldwide Survey of Heavy Lift Vessels", *Offshore Magazine*, November, 2014.



**Figure 6-29. Siapem 7000 and Heerema Thialf Semi-Submersible Crane Vessels**  
(Photos courtesy of Saimpem and Heerema)

#### 6.4.2. Cargo Barge Capacity

Cargo barge load capacity is limited although Heerema has constructed a large 750 foot long cargo barge as detailed in the Figure 6-30. Heerema H-851 cargo barge can carry topside modules weighing 35,000 mT or a jacket weighing 40,000 mT.



**Figure 6-30. Heerema H-851 Cargo Barge**  
(Drawing courtesy of Heerema)

### 6.4.3. Versabar Versatruss Lift System

Versatruss is a balanced, symmetrical, underside lift concept developed by Versabar that makes use of a truss formation to lift a heavy loads up to 7500 tons. In application, this system employs three readily available components:

- Standard cargo barges, which provide the lifting platforms
- Steel A frames, which provide the structural support
- Hydraulic winches, which supply the lifting force

Booms and the deck structure form the upper portion of the truss; the lower segment is created by Versatruss rigging and a tension cord inserted between the platform legs. This arrangement results in an extremely efficient distribution of load into the deck (Figure 6-31).

Once attached to the deck, synchronized winches are engaged, causing the barges to move together and shortening the lower span of the truss. When this happens, the booms rotate on their heel pins, increasing the boom angle and generating vertical lift. The process is fully reversible at any time, with lifting or set-down taking a relatively short period of time.

Because of the basic nature of this system, it can be designed to accommodate very large topsides. Once lifted, topsides can be towed to a new location or loaded onto a cargo barge.



**Figure 6-31. Versatruss Jacket Lifting System Topside/Jacket Lifting**  
(Photo courtesy of Versabar)

The Versatruss heavy lifting system is a proven, efficient method for removing and installing topsides. Multi-sheave blocks can minimize winch loads, and multiple booms and connection points give it redundancy not found in the other HLVs. Additionally, there is no theoretical limit to the load capacity

of this system. However, the Versatruss system is not well suited for removing jackets. The kinematics of the system make it difficult to provide a jacket lifting capability that would be effective in practical applications that require lifting jackets out of the water. Therefore, for Complete Removals, another HLV will be needed. Nevertheless, the Partial Removal and Remote Reefing operations might significantly benefit from the use of the Versatruss system.

#### 6.4.4. Versabar Bottom Feeder Lift Systems

The Bottom Feeder lift system was developed by Versabar. The design uses two cargo barges outfitted with a bridge truss that is used to lift jackets and decks Figure 6-32 in a single lift. Consisting of twin 1,250 ton steel truss frames mounted on standard cargo barges and powered by four 200-ton winches (visible on the legs of the trusses at left), the Bottom Feeder specializes in recovering items from the sea floor. The retrieved items are loaded onto barges and transported to shore for salvage. The current system has a rated lift capacity of 4,000 tons and has performed fifty plus salvages related lifts in the Gulf of Mexico since 2008.



**Figure 6-32. Versabar VB 4000 Bottom Feeder Lifting System**  
(Photo courtesy of Versabar)

Deployed for the first time in October 2010, a larger system designated the VB 10,000 is now in full operation. This unit is rated to handle 10,000 ton surface lifts with four 2,500 ton lift blocks. The blocks can be re-reeved as required to support sea bed lifting of 4,000 tons. The main block lift height is approximately 178 feet above sea level. The unit has ABS DPS3 class DP system (Kongsberg control

system, eight 1,000 HP Thrustmaster retractable, azimuthing thrusters). The Main hoists are also capable of each running 10,000 feet of 5-inch Samson Quantam-12 fiber rope. This will give the system a lifting/lowering capacity of 1,000 tons in 10,000 feet of water.



**Figure 6-33. Versabar VB 10,000**  
(Photo courtesy of Versabar)

The Bottom Feeder has the following advantages:

- Single piece lift (removal and installation) of heavy topsides for conventional (non-storm toppled) platforms.
- Heavy jacket removal and installation. The system may transport complete jackets to reef sites for toppling, or reverse upend jackets for removal to shore. For very large jackets the system can be used to support and transport jacket slices for disposal.
- Use of multiple lift blocks allows for lifting of decks/jackets which are highly out of level (up to 90 degrees) and with highly uncertain CoG or high CoG offset locations.
- High lift capacity at (-) 400 feet for continued toppled platform recovery.
- High capacity (1,000 tons) for future ultra-deep water (10,000 feet) installations and recoveries.
- DP system allows for station keeping in debris fields or deep water.
- System has proven to be as or more versatile than conventional derrick barge solutions.

The system's disadvantages include that the lifting system cannot operate in adverse sea states and the maximum size of the deck or jacket to be lifted is restricted by the distance between the two barge hulls.

### 6.4.5. Versabar Claw

In 2011, Versabar deployed a new underwater lift device named “The Claw” to minimize diver exposure during salvage operations. The Claw can retrieve topsides or damaged platforms from the seafloor with minimal subsea preparation. Two identical grappling devices measuring 122’ tall, 112’ wide and weighing 1,000 tons apiece are controlled by the VB 10,000 lift system. Each set of massive steel jaws operates independently, but for larger loads, can be used in tandem for a double claw lift.

Custom-engineered cradles can be lowered to the seafloor adjacent to sunken platforms to lift fragile topsides to the surface. Once the Claw scoops up the damaged topside and deposits it on the cradle, the entire lift package is brought to the surface, placing minimal further stress on the topside.

The Claw has performed a variety of lift operations retrieving various types of structures from 500 ft. below the surface to an above-water removal of a decommissioned standing platform.



**Figure 6-34. Versabar Claw Controlled by VB 10,000 Lift System**  
(Photo courtesy of Versabar)

### 6.4.6. Allseas Pioneering Spirit Twin Tanker Lift System

The Allseas Pioneering Spirit (formerly the Pieter Schelte), designed by Excalibur Engineering, BV, is a twin tanker lift system platform removal and installation vessel formed by joining two large tankers together to form a stable platform (Figure 6-35). Topsides and jackets can be removed in discrete single lifts and transported to shore or to another location. Delivery of this vessel is scheduled for first half of 2016.

The design of the HLV ties together two large tankers at the stern, leaving the bow open to accept extremely large topsides. The vessel ballasts itself below the deck, raises (deballasts) to a point where the jacket can be secured to the vessel, and further deballasts to raise the topsides off the jacket.

The Pioneering Spirit can be used for decommissioning operations by lifting topsides up to 48,000 tons and removing jackets up to 25,000 tons.



**Figure 6-35. Allseas Pioneering Spirit Lifting System Topsides/Jacket**  
(Drawing courtesy of Allseas)

The Pioneering Spirit heavy lift vessel offers a good alternative to lifting the topsides in one unit. This also allows much of the cleaning and separation of process facilities to be done onshore. Unlike other HLV alternatives, the Pioneering Spirit does not have to offload the topsides before lifting the first jacket section. Additionally, jacket cut sections could be skidded to the back of the vessel, allowing it to lift the remaining jacket portion to be immediately towed to shallow water to repeat the jacket removal process.

#### **6.4.7. Buoyancy Bag Devices**

Buoyancy bags, manufactured by companies like Seaflex Ltd., are inflatable subsea buoyancy systems that can be attached to jacket members, subsea equipment, conductors or pipelines. Once attached and inflated, these units can lift sections (or, in the case of jackets, potentially the entire structure) to the surface. The bags are offered in either open-bottom or fully enclosed configurations. These units can be connected to piles or conductors by using divers or remotely operated vehicles (ROVs).

These units have proven to be a successful lifting alternative in pipeline and platform removals. Current stock exceeds 3,000 ton lift capacity.



Buoyancy bags are inexpensive to fabricate and maintain. However, weather conditions can create difficulties for the jacket-handling vessels in raising the jacket. Movement created by underwater currents or uneven air expansion inside the bags could make it difficult to ensure that the jacket does not surface directly underneath the buoyancy bag-handling vessel or another onsite vessel.

#### 6.4.8. Controlled Variable Buoyancy System (CVBS)

The Controlled Variable Buoyancy System (CVBS) is a patented concept being developed to provide an innovative and cost effective means of offshore structure removal. It does this by providing buoyancy that is attached to strategic points on the structure. The magnitude of buoyant lift can be closely controlled throughout all stages of the removal operation.

The CVBS consists of groups of buoyancy chambers, clamps, inflatable air bags, pipe work, valves, and a sophisticated control system. A group of chambers equipped with clamps, local controls and piping systems is referred to as an Intelligent Buoyancy Unit (IBU).

An IBU consists of four 2.5m OD, 16m long shells (Figure 6-36). Three of the shells are perforated with a number of holes to allow water to flood freely in and out of the shell, and one of the shells is solid. The perforated shells have a domed end at the top fitted with an insert suitable for bolting on pipe work and valving.

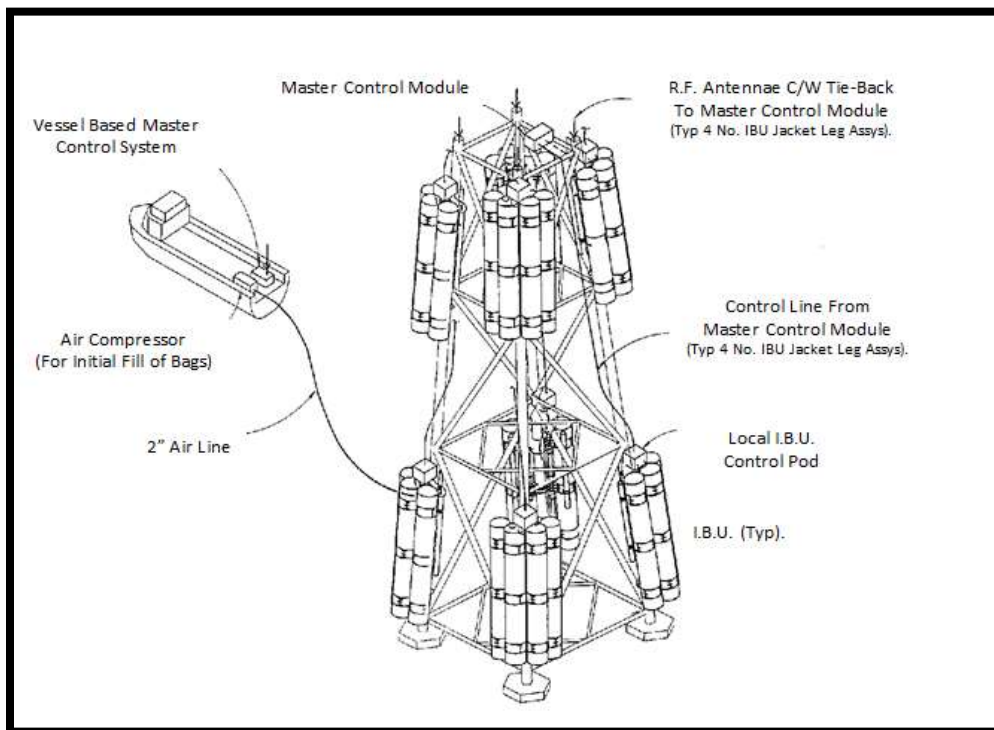

Figure 6-36. Control Variable Buoyancy System (CVBS)

The shells are held in position and connected to a jacket leg via 2 friction clamps, which are hinged to assist in the installation procedure. A steel band is fixed around the shell and is then connected into the main body of the clamp by means of stiffener plates. Each clamp has stud bolts that lock into position on closure and, when torqued, securely fix the unit to the leg.

The control system is located remotely onboard the support vessel and communicates with the control module via a radio telemetry link. The control module is located on the structure to be moved and is connected to each of the IBU units. This allows the control module to control the buoyancy of each IBU unit, control valve operations, and read pressure values and valve status information.

### **Buoyancy Bag Advantages**

- Potentially inexpensive lifting alternative – no need for HLVs to remain on site after topsides are removed.
- Environmentally friendly

### **Buoyancy Bag Disadvantages**

- Limited use in platform decommissioning
- Uncertainties exist regarding jacket surfacing logistics
- Maximum lifting weights limit the size of the jacket (or jacket section) that can be lifted (depending on size/number of bags or CVBSs used)

While the Controlled Variable Buoyancy System (CBVS) might be able to overcome some of the challenges presented by buoyancy bags (i.e., better control over the lift), this technology has limited use in the field.

### **6.4.9. Buoyancy Tank Assemblies**

Aker Solutions successfully deployed a new jacket removal method in 2008 to remove the DP2 jacket (see Figure 6-37) from Total's Frigg field in the Norwegian North Sea. With the aid of buoyancy tanks, the jacket was floated clear of the seabed and towed ashore without major incident. The jacket was towed to shallow water and cut into pieces for disposal.

The patented re-floating technique thereby has proved itself as an attractive alternative to conventional heavy-lift methods to remove redundant jackets.

The eight-leg DP2 jacket, installed in 1986 by barge-launch and ballasted into position, weighed around 9,000 metric tons (9,920 tons) and stood 123 m (404 ft) tall, with a footprint of 62 x 43 m (203 x 141 ft). Removal by heavy-lift would have meant cutting it into two or more pieces underwater.



**Figure 6-37. Frigg DP2 Platform Removal**

This re-floating method uses four buoyancy tank assemblies (BTAs), one attached to each corner leg. Each BTA consists of two cylindrical buoyancy tanks, each measuring 53 m (184 ft) long and 6.6 m (21.8 ft) in diameter, fixed together side by side. All tanks are divided into an upper and a lower compartment, with a series of valves allowing sea water entry during ballasting, and pumping in of pressurized air to expel water during deballasting.

On the upper end is an equipment and instrumentation room for implementing ballasting and deballasting, and for operating the clamps and pull-in jacks that attach the BTA to the jacket leg. Operations are controlled and powered remotely from a command vessel through an umbilical and hoses. These were connected directly to the BTA during the attachment operation, and via a manifold installed on the support vessel during the re-float and tow.

The overall height of each BTA is 65 m (213 ft), the weight in air is about 1,000 metric tons (1,102 tons). Total tank volume is 3,625 cu m (128,016 cu ft). The units were built and outfitted by Bladt Industrier in Denmark. The clamp systems and jacks were supplied by IHC, and the rubber elements by Trelleborg Viking in Norway – the latter were used as fenders and placed within the clamps and upper and lower guides to deflect loadings.

The mating operation to position a BTA to one of the corner legs without any damage to the integrity of the jacket was not easy, especially as a positioning accuracy of  $\pm 15$  mm (0.6-in.) was required, and the

weight of each assembly now included 3,000 metric tons (3,308 tons) of ballast water. Each BTA (Figure 6-38) was guided into position using lines attached to a vessel on either side; the offshore support vessel Botnica, acting as the command vessel, and Nordica. A pull-back line was attached to a small tug stationed behind the BTA.

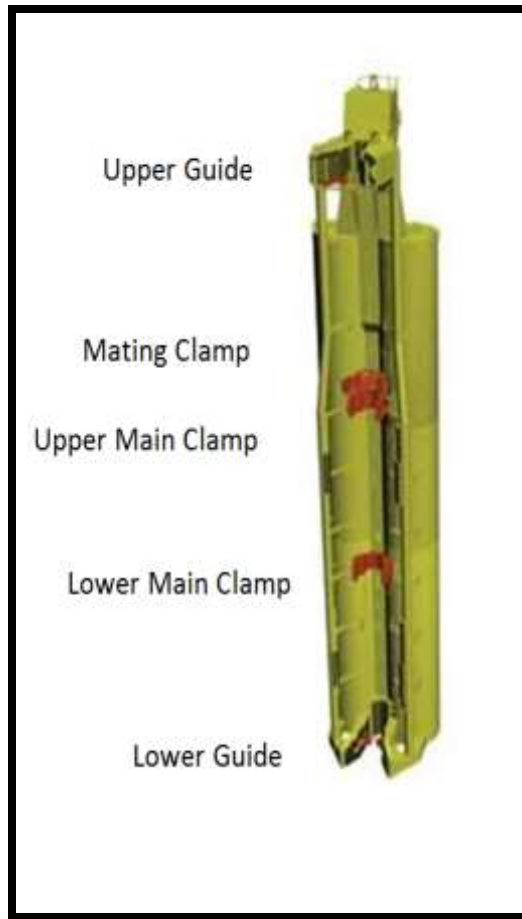

**Figure 6-38. Buoyancy Tank Assembly**

Before re-floating began, the towing vessels attached lines to the jacket to ensure it remained stable. At this point, the jacket was held in place by just four of the original 20 piles, the others having been previously cut. With only 600 metric tons (661 tons) of buoyancy from each BTA before the last piles were cut, the jacket was resting firmly on the already cut piles – enough to hold it stable without causing any sudden movement when the final pile was severed.

Once the jacket was no longer fixed to the seabed, the BTAs were further de-ballasted to raise the deepest part of the platform to the towing height of 10 m (33 ft) above the seabed.

The BTAs are available for re-use. With their dimensions, they could re-float jackets weighing between 6,000 and 18,000 metric tons (6,614 and 19,842 tons), depending on the floating capacity in the legs.

Further, BTAs with different dimensions and lifting capacities also could be built. BTAs have been designed to operate in 10,000 feet of water depth.

#### 6.4.10. SeaMetric International TML Lift System

An alternative heavy lift concept has been developed by Seametric International.

SeaMetric's Twin Marine Lifter (TML) design (see Figure 6-39) is unique. It uses lifting arms rather than cranes, and will be able to lift 22,000 short tons compared to the maximum lifting capacity of traditional heavy-lift vessels at about 16,000 short tons. Another factor that makes the TML system stand alone is the removable lifting arms.

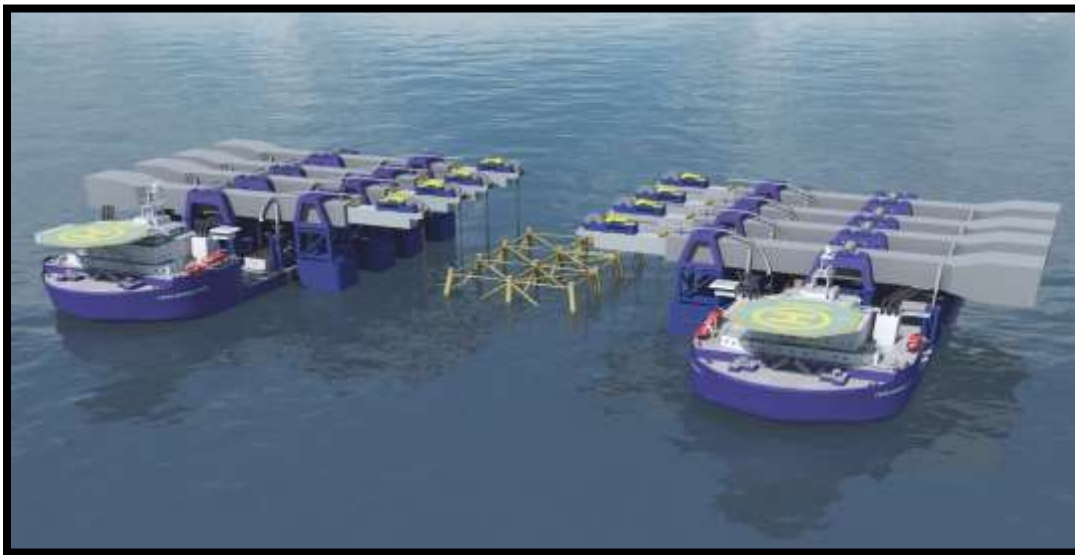

**Figure 6-39. Seametric International Twin Marine Lifter**  
(Drawing courtesy of Seametric)

The TML system has DP-3 capability and includes both accommodation facilities and a helideck. It will operate at wave heights of 10-15 ft with low dynamic loads.

The TML allows design of platform topsides for convenience of operation, not to fit within the crane's lifting range. The self-propelled vessel (450 feet long) is designed for both removal and installation of platform topsides, jackets, subsea installations, boats, or similar objects.

The TML system is based on buoyancy and ballast tanks and lifting arms located on two identical vessels, each vessel being 459 ft x 131 ft x 35 ft).

The eight lifting arms are supported on a skid structure onboard the vessels. Each lifting arm is hinged to the skid structure over the center line of the vessel and is equipped with a buoyancy tank on the inside (between the barge and the object) and a ballast tank on the opposite side.

One TML with lifting arms is positioned on each side of the object to be lifted. The system creates a lift force by de-ballasting the buoyancy tanks while ballasting the ballast tanks. This is done by the use of seawater pumps.

## 7. Selecting Decommissioning Technologies

With a few exceptions, the decommissioning techniques used in U.S. waters have remained basically the same for decades with incremental advances in the established techniques. Exceptions include:

- Techniques under development for decommissioning installations in ever deeper water that will include subsea structures and Floating Production Storage and Offloading (FPSO) facilities
- Increased and more common use of remotely operated vehicles (ROVs)
- Limited use of the jacket reverse launch technique
- Increased capability for the recovery and decommissioning of damaged or downed platforms

Although many techniques are basically the same, the methods to perform the techniques have undergone some innovation. The decommissioning techniques vary by the type of asset decommissioned, e.g., wells, pipelines, or platforms.

The following tables present lists of decommissioning techniques for each type of major asset, identifies characteristics required to properly estimate or plan the work, and provides some additional comments or details on their applicability. Specific details such as water depth, resources required, and the number of assets involved affects the selection of techniques for any particular project.

Following each table, decision flowcharts illustrate the process for selecting the most appropriate decommissioning technique. The flowcharts describe the sequence of steps in the decommissioning process and indicate the major decisions and choices that need to be made based on the individual circumstances.

### 7.1. Well Plugging and Abandonment

**Table 7-1. Well Plugging and Abandonment Techniques**

Well Plugging and Abandonment Techniques		
Facility Type	Characteristics	Abandonment Technique
Fixed Platform Wells	<ul style="list-style-type: none"> <li>• Problem Free Wells on platform that can support P&amp;A spread</li> </ul>	<ul style="list-style-type: none"> <li>• Use a Workboat &amp; Rigless Abandonment</li> <li>• If no platform crane or insufficient capacity, include a portable crane or casing jacks. Drilling Rig, if present on the platform, is used in place of jacks</li> <li>• Rig-up, perform diagnostics and P&amp;A the wells</li> </ul>
Fixed Platform Wells	<ul style="list-style-type: none"> <li>• Problem Free Wells on platform that cannot support P&amp;A spread</li> </ul>	<ul style="list-style-type: none"> <li>• Use a Liftboat &amp; Rigless Abandonment</li> <li>• If no platform crane or insufficient capacity, include a portable crane or casing jacks</li> <li>• Rig-up, perform diagnostics and P&amp;A the wells</li> </ul>

Well Plugging and Abandonment Techniques		
Facility Type	Characteristics	Abandonment Technique
Fixed Platform Wells	<ul style="list-style-type: none"> <li>Problem Wells on platform that can support P&amp;A spread</li> </ul>	<ul style="list-style-type: none"> <li>Use a Workboat &amp; Rigless Abandonment</li> <li>Depending on well problem, the following spread(s) would be included               <ul style="list-style-type: none"> <li>Snubbing Unit</li> <li>Coil Tubing Unit</li> <li>Hydraulic Workover Unit</li> <li>Drilling Rig</li> <li>Milling Tools</li> </ul> </li> <li>If no platform crane or insufficient capacity, include a portable crane or casing jacks. Drilling Rig, if present on the platform, is used in place of jacks</li> <li>Rig-up, perform diagnostics and P&amp;A the wells</li> </ul>
Fixed Platform Wells	<ul style="list-style-type: none"> <li>Problem Wells on platform that cannot support P&amp;A spread</li> </ul>	<ul style="list-style-type: none"> <li>Use a Liftboat &amp; Rigless Abandonment</li> <li>Depending on well problem, the following spread(s) would be included               <ul style="list-style-type: none"> <li>Snubbing Unit</li> <li>Coil Tubing Unit</li> <li>Hydraulic Workover Unit</li> <li>Drilling Rig</li> <li>Milling Tools</li> </ul> </li> <li>If no platform crane or insufficient capacity, include a portable crane or casing jacks. Drilling Rig, if present on the platform, is used in place of jacks</li> <li>Rig-up, perform diagnostics and P&amp;A the wells</li> </ul>
Floating Platform Dry Tree Wells	<ul style="list-style-type: none"> <li>Problem Free Wells</li> </ul>	<ul style="list-style-type: none"> <li>Use a Workboat, Rigless Abandonment and casing jacks. Drilling Rig, if present on the platform, is used in place of jacks</li> <li>Rig-up, perform diagnostics and P&amp;A the wells</li> </ul>
Floating Platform Dry Tree Wells	<ul style="list-style-type: none"> <li>Problem Wells</li> </ul>	<ul style="list-style-type: none"> <li>Use a Workboat, Rigless Abandonment and casing jacks. Drilling Rig, if present on the platform, is used in place of jacks</li> <li>Depending on well problem, the following spread(s) would be included               <ul style="list-style-type: none"> <li>Snubbing Unit</li> <li>Coil Tubing Unit</li> <li>Hydraulic Workover Unit</li> <li>Drilling Rig</li> <li>Milling Tools</li> </ul> </li> <li>Rig-up, perform diagnostics and P&amp;A the wells</li> </ul>



Well Plugging and Abandonment Techniques		
Facility Type	Characteristics	Abandonment Technique
Subsea Wells	<ul style="list-style-type: none"> <li>Water Depth &lt;800m?</li> <li>Non Problem Well or Problem Well?</li> <li>Divers or ROV?</li> <li>Can well be plugged using rigless methods?</li> </ul>	<ul style="list-style-type: none"> <li>Selection of work and vessel spreads depends on condition of well and water depth <ul style="list-style-type: none"> <li>Rig-up, perform diagnostics and P&amp;A the wells</li> <li>Complete Removal 15' bellow mud line.</li> <li>Remove Tree and wellhead, unless waiver to leave wellhead is obtained</li> </ul> </li> </ul>
Subsea Wells	<ul style="list-style-type: none"> <li>Water Depth &gt;800m</li> <li>Non Problem Well or Problem Well</li> <li>Divers and or ROV</li> <li>Can well be plugged using rigless methods?</li> </ul>	<ul style="list-style-type: none"> <li>Selection of work and vessel spreads depends on condition of well and water depth <ul style="list-style-type: none"> <li>Rig-up, perform diagnostics and P&amp;A the wells</li> <li>Remove Tree, obtain waiver to leave wellhead</li> </ul> </li> </ul>

## 7.2. Pipeline Decommissioning

Table 7-2. Pipeline Abandonment Techniques

Pipeline Abandonment Techniques		
Facility Type	Characteristics	Abandonment Technique
Riser to Riser Riser to SSTI SSTI to SSTI	<ul style="list-style-type: none"> <li>Diameter, length, product</li> <li>Flushed fluids can or cannot be pumped down hole, through the pipeline or filtering equipment is or is not present on the receiving end</li> </ul>	<ul style="list-style-type: none"> <li>Selection of work and vessel spreads depends on type of pipeline, whether fluids are flushed, depth of cover over the pipeline, and water depth <ul style="list-style-type: none"> <li>Flushed clean, cut ends, remove a section from each end, plug and bury</li> <li>Flush clean and remove pipeline in sections</li> <li>Flush clean and remove pipeline by reverse reeling</li> </ul> </li> </ul>

## 7.3. Umbilical Decommissioning

Table 7-3. Umbilical Decommissioning Techniques

Umbilical Decommissioning Techniques		
Facility Type	Characteristics	Abandonment Technique

Umbilical Decommissioning Techniques		
Facility Type	Characteristics	Abandonment Technique
ALL	<ul style="list-style-type: none"> <li>• Diameter, length</li> <li>• Purpose - Electrical or other</li> </ul>	<ul style="list-style-type: none"> <li>• Selection of work and vessel spreads depends on length, size and purpose of umbilical and water depth <ul style="list-style-type: none"> <li>○ Flush clean non- electrical umbilicals.</li> </ul> </li> <li>• Abandonment in place - The ends cut, plugged and buried. Umbilicals are to be removed unless waiver is obtained to abandon in place</li> <li>• Abandonment by removal – The ends cut and umbilical is removed</li> </ul>

## 7.4. Platform Decommissioning

### 7.4.1. Fixed Platforms

Table 7-4. Fixed Platform Decommissioning Techniques

Fixed Platform Decommissioning Techniques		
Facility Type	Characteristics Required	Abandonment Technique
Caisson	<ul style="list-style-type: none"> <li>• Caisson Diameter</li> <li>• Deck Weight &amp; Dimensions</li> <li>• Caisson Weight and Dimensions</li> <li>• Is Caisson bottle-necked or straight?</li> <li>• Water depth dependent on diving, ROV spread</li> </ul>	<ul style="list-style-type: none"> <li>• Complete Removal to an on-shore disposal facility* with an appropriate sized HLV spread</li> <li>• Water depth is usually too shallow for reefing</li> </ul> <p>*The HLV operator takes possession when the platform is seafastened to the CB. The HLV operator would realize any disposal costs, profit from sale for reuse or sale as scrap.</p>
Braced Caisson	<ul style="list-style-type: none"> <li>• Number of Piles/Braces</li> <li>• Caisson Diameter</li> <li>• Pile Diameter</li> <li>• Deck Weight &amp; Dimensions</li> <li>• Caisson Weight and Dimensions</li> <li>• Is Caisson bottle-necked or straight?</li> <li>• Water depth dependent on diving, ROV spread</li> </ul>	<ul style="list-style-type: none"> <li>• Complete Removal to an on-shore disposal facility* with an appropriate sized HLV spread</li> <li>• Water depth is usually too shallow for reefing**</li> </ul>

Fixed Platform Decommissioning Techniques		
Facility Type	Characteristics Required	Abandonment Technique
Platforms (3 Pile and Greater)	<ul style="list-style-type: none"> <li>Number of Piles if different from legs</li> <li>Pile Diameter</li> <li>Deck Weight &amp; Dimensions</li> <li>Jacket Weight and Dimensions</li> <li>Water depth dependent on diving, ROV spread</li> </ul>	<ul style="list-style-type: none"> <li>Complete Removal to an on-shore disposal facility* as a single lift, in multiple lifts in-situ, or hopping off site, with all material removed to shore</li> <li>Remove top 85' section to shore disposal facility* and reef remainder in place</li> <li>Reef top 85' section next to lower section in place</li> <li>In-Situ (Topple as a reef)</li> <li>Remove to a remote Reef Site intact or in pieces</li> </ul>
Compliant Tower (without guy lines)	<ul style="list-style-type: none"> <li>Number of Piles if different from legs</li> <li>Pile Diameter</li> <li>Deck Weight &amp; Dimensions</li> <li>Jacket Weight and Dimensions</li> <li>Buoyancy tank details</li> <li>Water depth dependent on diving, ROV spread</li> </ul>	<ul style="list-style-type: none"> <li>Complete Removal in multiple lifts in-situ or by re-floating and moving to shallow water for sectioning, with all material removed to shore disposal facility*</li> <li>Remove top 85' section to shore and reef remainder in place</li> <li>Reef in situ with top 85' section next to lower section in place</li> <li>In-Situ (Topple as a reef)</li> <li>Re-float, remove to a remote Reef Site intact and sink or place on the seabed</li> </ul>
Compliant Tower (with guy lines)	<ul style="list-style-type: none"> <li>Number of Piles if different from legs</li> <li>Pile Diameter</li> <li>Deck Weight &amp; Dimensions</li> <li>Jacket Weight and Dimensions</li> <li>Buoyancy tank details</li> <li>Guy line details</li> <li>Water depth dependent on diving, ROV spread</li> </ul>	<ul style="list-style-type: none"> <li>Complete Removal by re-floating and moving to shallow water for sectioning, with all material removed to shore</li> <li>In-Situ (Topple as a reef)</li> <li>Re-float, remove to a remote Reef Site intact and sink or place on the seabed</li> </ul>

## 7.4.2. Floating Platforms

Table 7-5. Floating Platform Decommissioning Techniques

Floating Platform Decommissioning Techniques		
Facility Type	Characteristics Required	Abandonment Technique
FPSO	<ul style="list-style-type: none"> <li>Hull Weight and Dimensions</li> <li>Weight and Dimensions of Equipment</li> <li>Mooring System Details</li> <li>Water Depth</li> </ul>	<ul style="list-style-type: none"> <li>Complete Removal to an on-shore disposal facility</li> </ul>

Floating Platform Decommissioning Techniques		
Facility Type	Characteristics Required	Abandonment Technique
MTLP / TLP	<ul style="list-style-type: none"> <li>Hull Weight and Dimensions</li> <li>Deck Weight and Dimensions</li> <li>Equipment Weight and Dimensions</li> <li>Mooring System Details</li> <li>Water Depth</li> </ul>	<ul style="list-style-type: none"> <li>Complete Removal to an on-shore disposal facility</li> <li>Remove deck to shore and hull to shallow water for reefing</li> </ul>
Semi-submersible	<ul style="list-style-type: none"> <li>Hull Weight and Dimensions</li> <li>Deck Weight and Dimensions</li> <li>Equipment Weight and Dimensions</li> <li>Mooring System Details</li> <li>Water Depth</li> </ul>	<ul style="list-style-type: none"> <li>Complete Removal to an on-shore disposal facility</li> <li>Remove deck to shore and hull to shallow water for reefing</li> </ul>
Spar	<ul style="list-style-type: none"> <li>Hull Weight and Dimensions</li> <li>Deck Weight and Dimensions</li> <li>Equipment Weight and Dimensions</li> <li>Mooring System Details</li> <li>Water Depth</li> </ul>	<ul style="list-style-type: none"> <li>Complete Removal to an on-shore disposal facility</li> <li>Remove deck to shore and hull to shallow water for reefing</li> </ul>

## 7.5. Subsea Structure Decommissioning

Table 7-6. Subsea Structure Decommissioning Techniques

Subsea Structure Decommissioning Techniques		
Facility Type	Characteristics Required	Abandonment Technique
Manifolds	<ul style="list-style-type: none"> <li>Lift weights &amp; dimensions</li> <li>Water Depth</li> </ul>	<ul style="list-style-type: none"> <li>Complete Removal</li> <li>Abandon in-place</li> </ul>
PLET	<ul style="list-style-type: none"> <li>Lift weights &amp; dimensions</li> <li>Water Depth</li> </ul>	<ul style="list-style-type: none"> <li>Complete Removal</li> <li>Abandon in-place</li> </ul>
Jumper	<ul style="list-style-type: none"> <li>Lift weights &amp; dimensions</li> <li>Water Depth</li> </ul>	<ul style="list-style-type: none"> <li>Complete Removal</li> <li>Abandon in-place</li> </ul>
Wellhead and Subsea Tree	<ul style="list-style-type: none"> <li>Lift weights &amp; dimensions</li> <li>Water Depth</li> </ul>	<ul style="list-style-type: none"> <li>Complete Removal</li> <li>Abandon in-place</li> </ul>
SUTA	<ul style="list-style-type: none"> <li>Lift weights &amp; dimensions</li> <li>Water Depth</li> </ul>	<ul style="list-style-type: none"> <li>Complete Removal</li> <li>Abandon in-place</li> </ul>

## 7.6. Decision Flowcharts

Decision flowcharts illustrate the process for selecting the most appropriate decommissioning technique. The flowcharts describe the sequence of steps in the decommissioning process and indicate the major decisions and choices that need to be made based on the individual circumstances.

Flowcharts are presented for

- Well Plugging and Abandonment, Platform Wells (Dry Tree)
- Well Plugging and Abandonment, Subsea Wells (Wet Tree)
- Pipeline Decommissioning, Riser to Riser
- Pipeline Decommissioning, Riser to SSTI
- Pipeline Decommissioning, SSTI to SSTI
- Umbilical Decommissioning
- Platform Decommissioning, Fixed Platforms, Caisson
- Platform Decommissioning, Fixed Platforms, Caisson, Single Lift
- Platform Decommissioning, Fixed Platforms, Braced Caisson
- Platform Decommissioning, Fixed Platforms, Steel Jacket, Complete Removal
- Platform Decommissioning, Fixed Platforms, Steel Jacket, Artificial Reef
- Platform Decommissioning, Floating Platforms
- Subsea Structure Decommissioning

### 7.6.1. Well Plugging and Abandonment

#### 7.6.1.1. Platform Wells (Dry Tree)

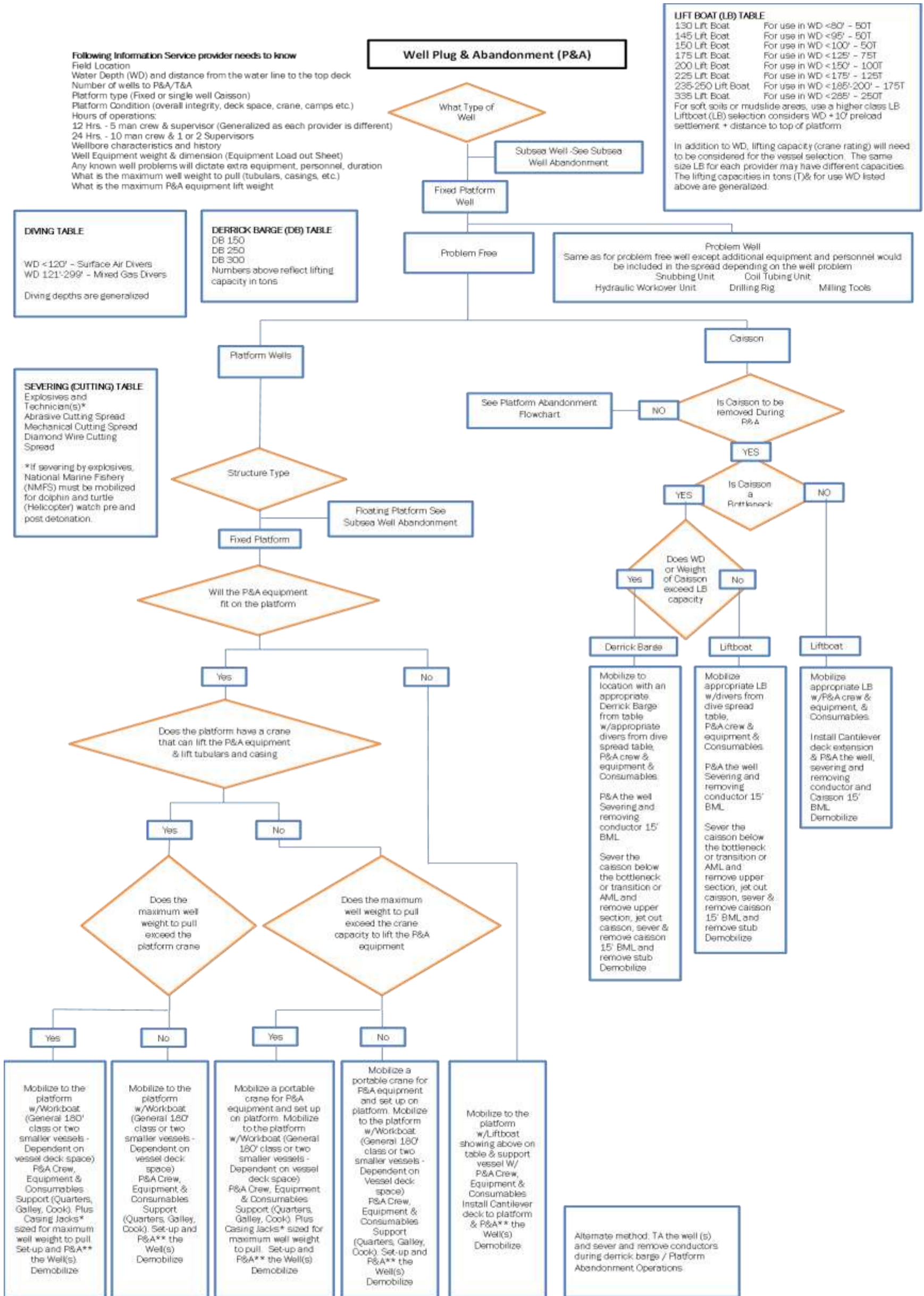

7.6.1.2. Subsea Wells (Wet Tree)

Following Information Service provider needs to know

- Field Location
- Water Depth (WD)
- Number of wells to P&A/T&A
- Hours of operations:
  - 12 Hrs. - 5 man crew & supervisor (Generalized as each provider is different)
  - 24 Hrs. - 10 man crew & 1 or 2 Supervisors
- Wellbore characteristics and history
- Well Equipment weight & dimension (Equipment Load out Sheet)
- Any known well problems will dictate extra equipment, personnel, duration
- What is the maximum well weight to pull (tubulars, casings, etc.)

**DIVING TABLE**

WD <120' – Surface Air Divers  
 WD 121'-299' – Mixed Gas Divers  
 WD 300'-800' – Saturation Divers  
 WD > 800' – ROV only  
 Diving depths are generalized

**Subsea Well Abandonment**

**WELL INTERVENTION VESSEL TABLE**

WD <299' – Jack-up Rig, Moored Semi-Sub Rig, Semi-sub DP, Drillship, MSV, MSV-T  
 WD 300' – 2,000' – Moored Semi-Sub Rig, Semi-sub DP, Drillship, MSV-T  
 WD > 2,001' – Semi-sub DP, Drillship, MSV, MSV-T  
 Limitation is equipment depth capability

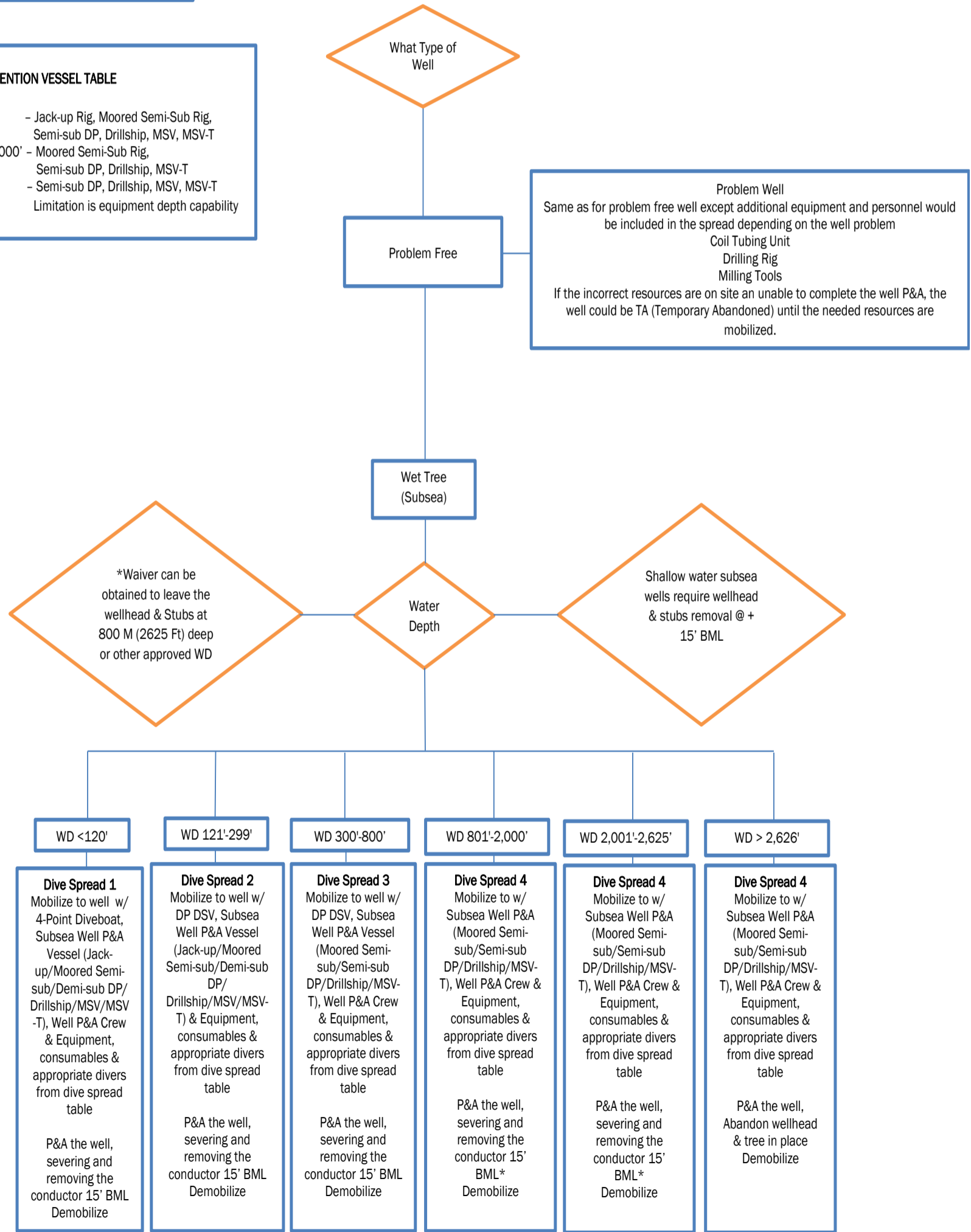

## 7.6.2. Pipeline Decommissioning

### 7.6.2.1. Riser to Riser

Water Depth (WD) at origination  
 Water Depth at destination  
 Maximum (Max) WD is the greater of the two  
 Pipeline Size OD (in.)  
 Segment Length (ft.)  
 Product  
 Status code

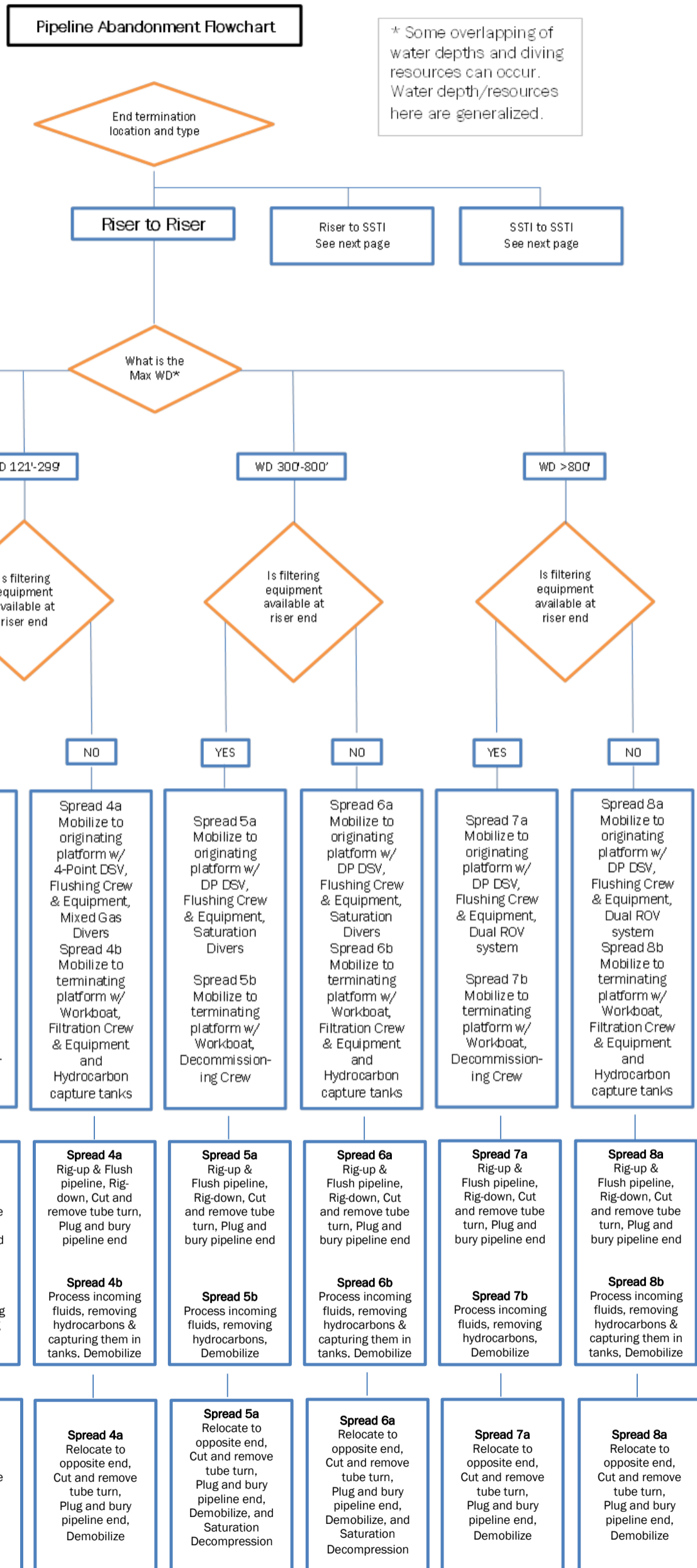



7.6.2.2. Riser to SSTI

Water Depth (WD) at origination  
 Water Depth at destination  
 Maximum (Max) WD is the greater of the two  
 Size OD (in.)  
 Length (ft.)  
 Product  
 Status code

\* Some overlapping of water depths and diving resources can occur. Water depth/resources here are generalized.

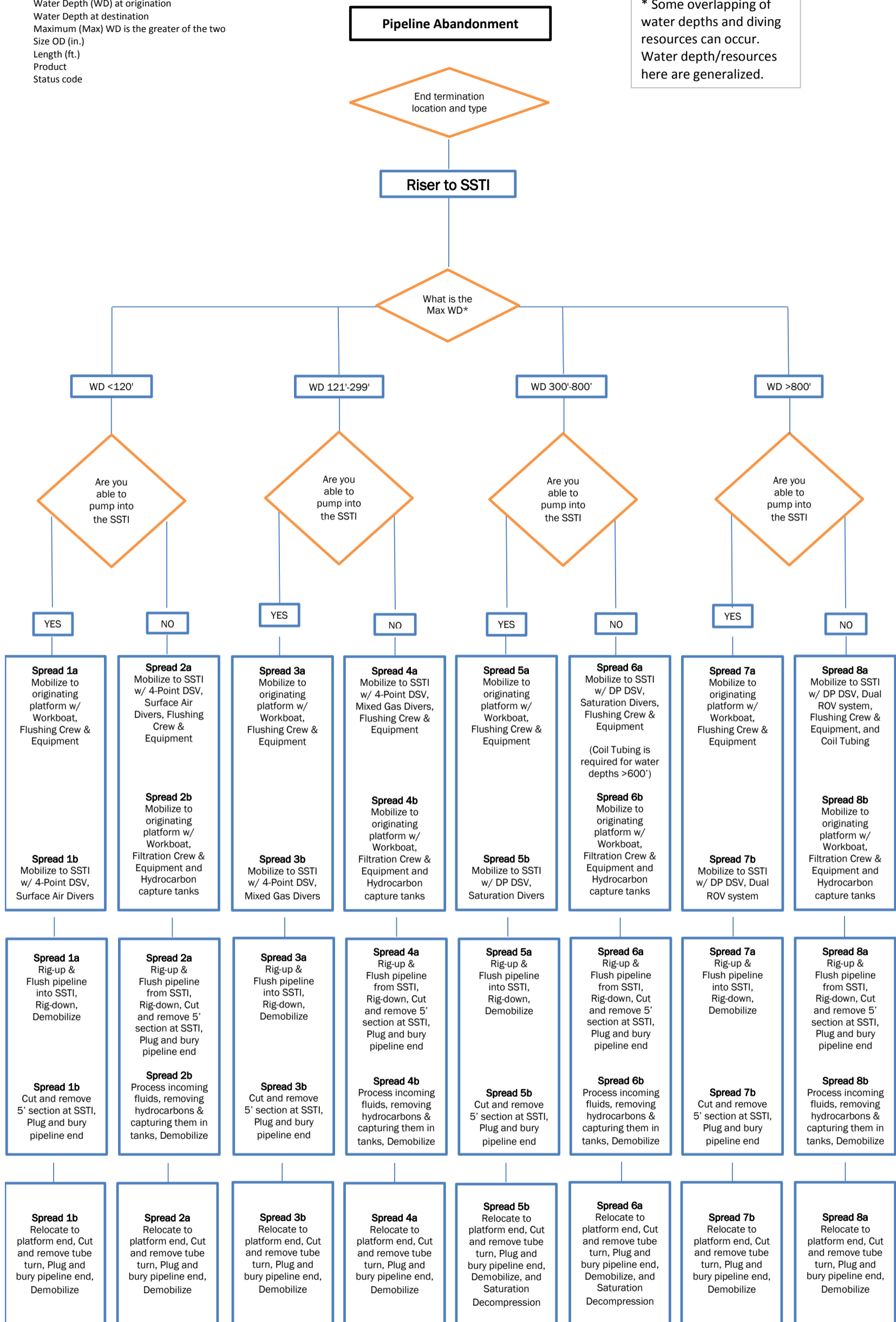

7.6.2.3. SSTI to SSTI

Water Depth (WD) at origination  
 Water Depth at destination  
 Maximum (Max) WD is the greater of the two  
 Size OD (in.)  
 Length (ft.)  
 Product  
 Status code

\* Some overlapping of water depths and diving resources can occur. Water depth/resources here are generalized.

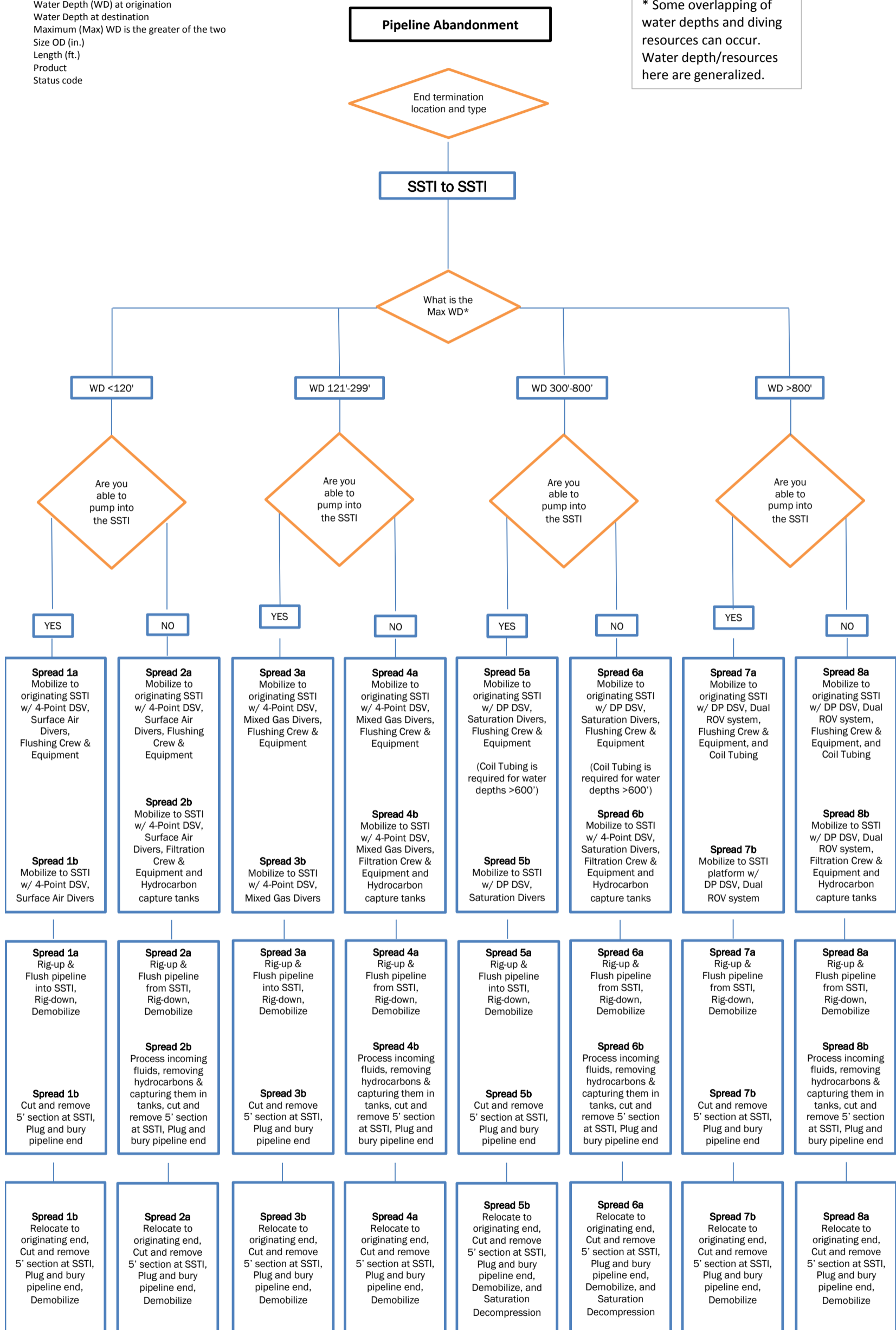

### 7.6.3. Umbilical Decommissioning

Water Depth (WD) at origination  
 Water Depth at destination  
 Maximum (Max) WD is the greater of the two  
 Size OD (in.)  
 Length (ft.)  
 Product  
 Status code

\* Some overlapping of water depths and diving resources can occur. Water depth/resources here are generalized.

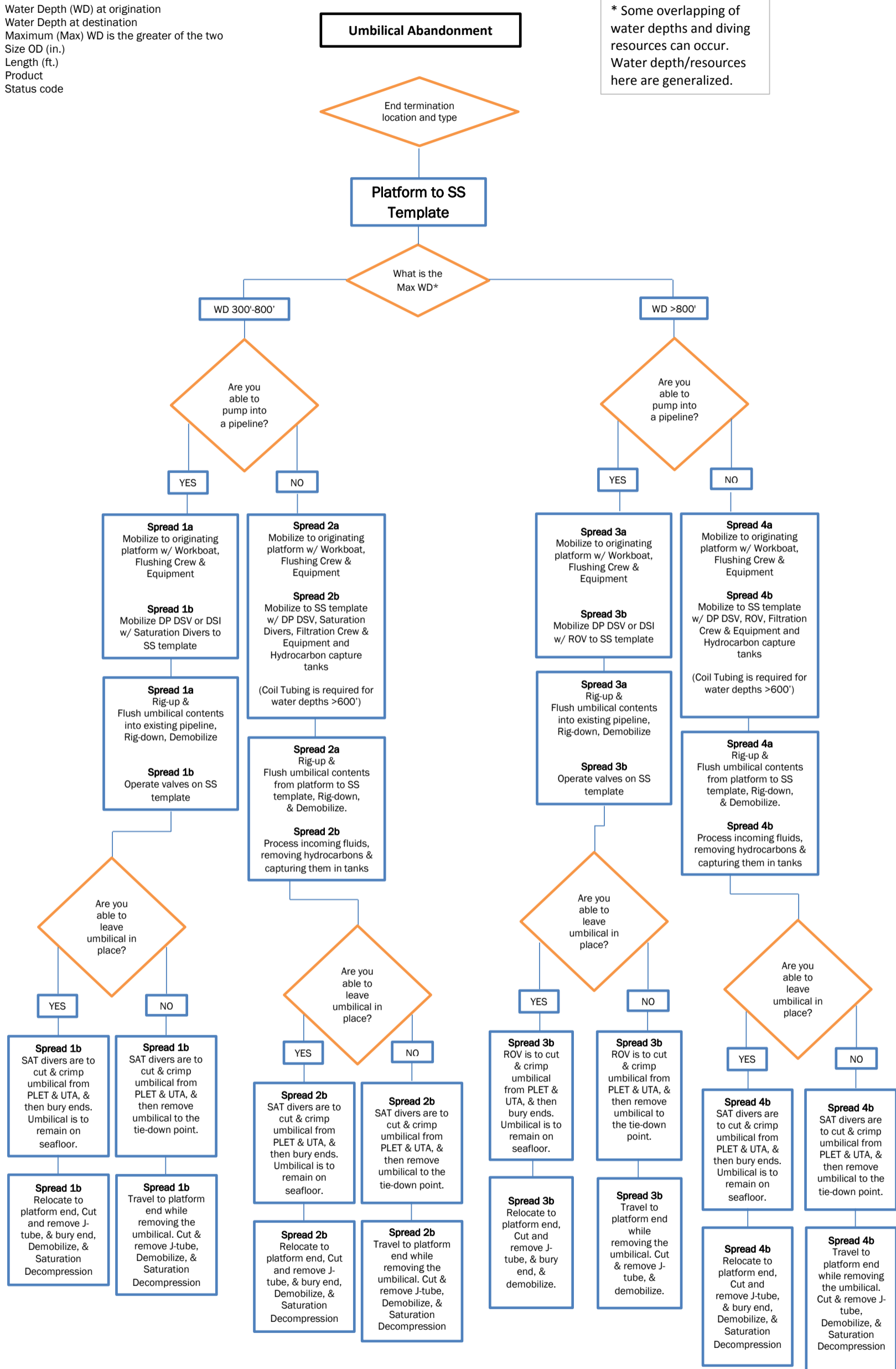

### 7.6.4. Platform Decommissioning

#### 7.6.4.1. Fixed Platforms

Service provider required information

- Location
- Type of Platform (Fixed, Floating)
- Water Depth (WD) and distance from the water line to the top deck
- Function of Platform (Drilling/Production/Quarters/Manifold/Wellhead or Protector, Caisson, etc)
- Number of Deck Legs
- Number of Jacket Legs
- Number of Piles and/or Skirt Piles
- Diameter of piles and wall thickness
- Equipment installed on deck after deck was installed and lift weights
- Deck Lift Weight and dimensions for Heavy Lift Vessel (Derick Barge [DB]) selection and Cargo Barge selection
- Jacket Lift Weight and dimensions for Heavy Lift Vessel (Derick Barge [DB]) selection and Cargo Barge selection
- Are pile annuluses grouted
- Are skirt piles grouted inside the pile
- What are soil conditions at location
- Pile Severing Method to be used
- Number of Conductors Present
- Conductor Severing Method to be used
- Caisson Severing Method to be used
- Is Caisson a straight Caisson or a Bottleneck
- Wells and pipelines are abandoned prior to structure removal

**Fixed Platform Abandonment Flowchart - Caisson**

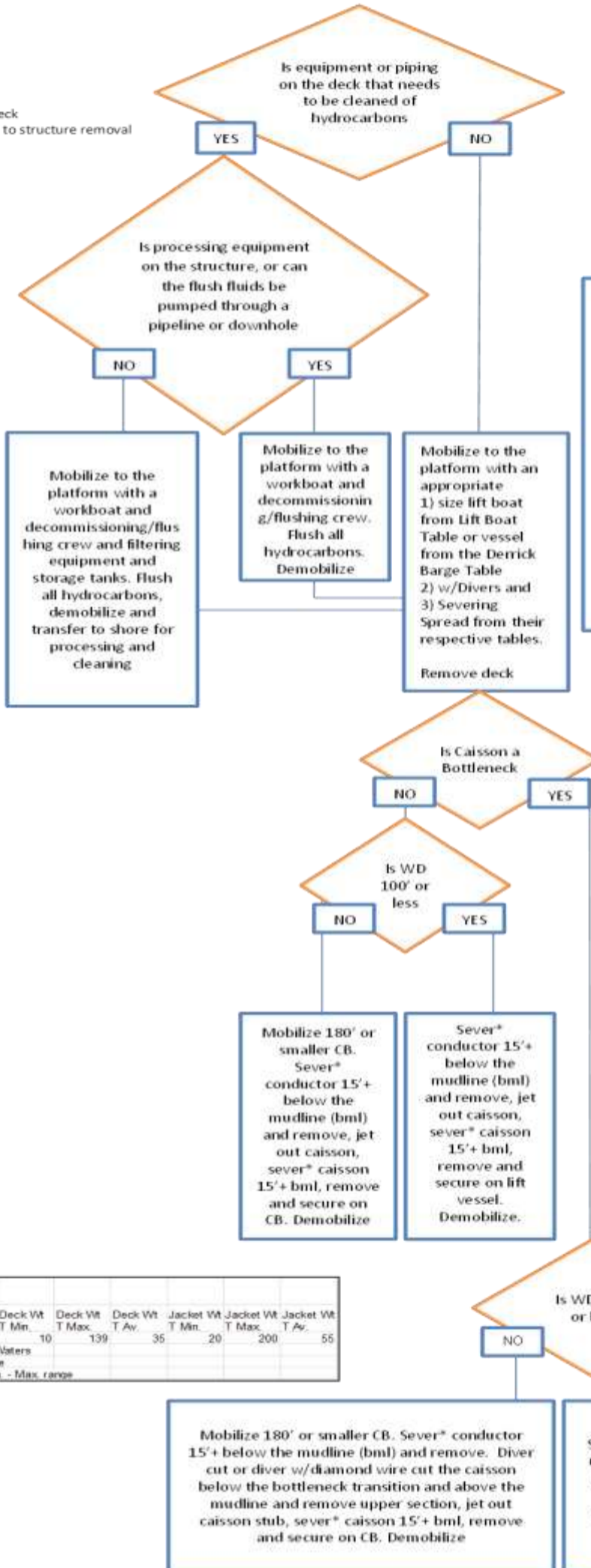

Some overlapping of water depths and diving resources can occur. Water depth/resources here are generalized.

**LIFT BOAT (LB) TABLE**

130 Lift Boat	For use in WD <80' – 50T
145 Lift Boat	For use in WD <95' – 50T
150 Lift Boat	For use in WD <100' – 50T
175 Lift Boat	For use in WD <125' – 75T
200 Lift Boat	For use in WD <150' – 100T
225 Lift Boat	For use in WD <175' – 125T
235-250 Lift Boat	For use in WD <185'-200' – 175T
335 Lift Boat	For use in WD <285' – 250T

For soft soils or mudslide areas, use a higher class LB  
Liftboat (LB) selection considers WD +10' preload settlement + distance to top of platform

In addition to WD, lifting capacity (crane rating) will need to be considered for the vessel selection. The same size LB for each provider may have different capacities. The lifting capacities in tons (T) listed above are generalized

Note: LB will not lift max weight.

**DIVING SPRED TABLE**

WD <120'	Workboat w/Surface Air Divers
WD 121'-299'	4 Point DSV w/Mixed Gas Divers
WD 300'-800'	4 Point or DPH DSV w/SAT Divers Or ROV with Sonar
WD > 801'	ROV with Sonar

**DERRICK BARGE (DB) TABLE**

DB 150
DB 250
DB 300
DB 400
DB 500
DB 600/800
DB 2,000 or Greater
VB 10,000
SSCV 7,000
SSCV (2) 7,000
SSCV 9,000

Numbers above reflect lifting capacity in tons

**SEVERING (CUTTING) TABLE**

- Explosives and Technician(s)\*
- Abrasive Cutting Spread
- Mechanical Cutting Spread
- Diamond Wire Cutting
- Spread

\*If severing by explosives, National Marine Fishery (NMFS) must be mobilized for dolphin and turtle (Helicopter) watch pre and post detonation

**LIFT WEIGHT TABLE**

Number of Jacket Legs	Deck Wt		Deck Wt T Max	Deck Wt T Av	Jacket Wt		Jacket Wt T Max	Jacket Wt T Av
	Min*	Max**			T Min	T Max		
1 Caisson	50	138	139	35	20	200	55	

\* Minimum considered in this study for Federal Waters  
\*\* Maximum from data available in TSB database  
T = Tons, AV = Average all structures in the Min - Max range

Service provider required information  
 Location  
 Type of Platform (Fixed, Floating)  
 Water Depth (WD) and distance from the water line to the top deck  
 Function of Platform (Drilling/Production/Quarters/Manifold/Wellhead or Protector, Caisson, etc)  
 Number of Deck Legs  
 Number of Jacket Legs  
 Number of Piles and/or Skirt Piles  
 Diameter of piles and wall thickness  
 Equipment installed on deck after deck was installed and lift weights  
 Deck Lift Weight and dimensions for Heavy Lift Vessel (Derick Barge [DB]) selection and Cargo Barge selection  
 Jacket Lift Weight and dimensions for Heavy Lift Vessel (Derick Barge [DB]) selection and Cargo Barge selection  
 Are pile annuluses grouted  
 Are skirt piles grouted inside the pile  
 What are soil conditions at location  
 Pile Severing Method to be used  
 Number of Conductors Present  
 Conductor Severing Method to be used  
 Caisson Severing Method to be used  
 Is Caisson a straight Caisson or a Bottleneck  
 Wells and pipelines are abandoned prior to structure removal

**Fixed Platform Abandonment Flowchart – Caisson – ALTERNATE METHOD**

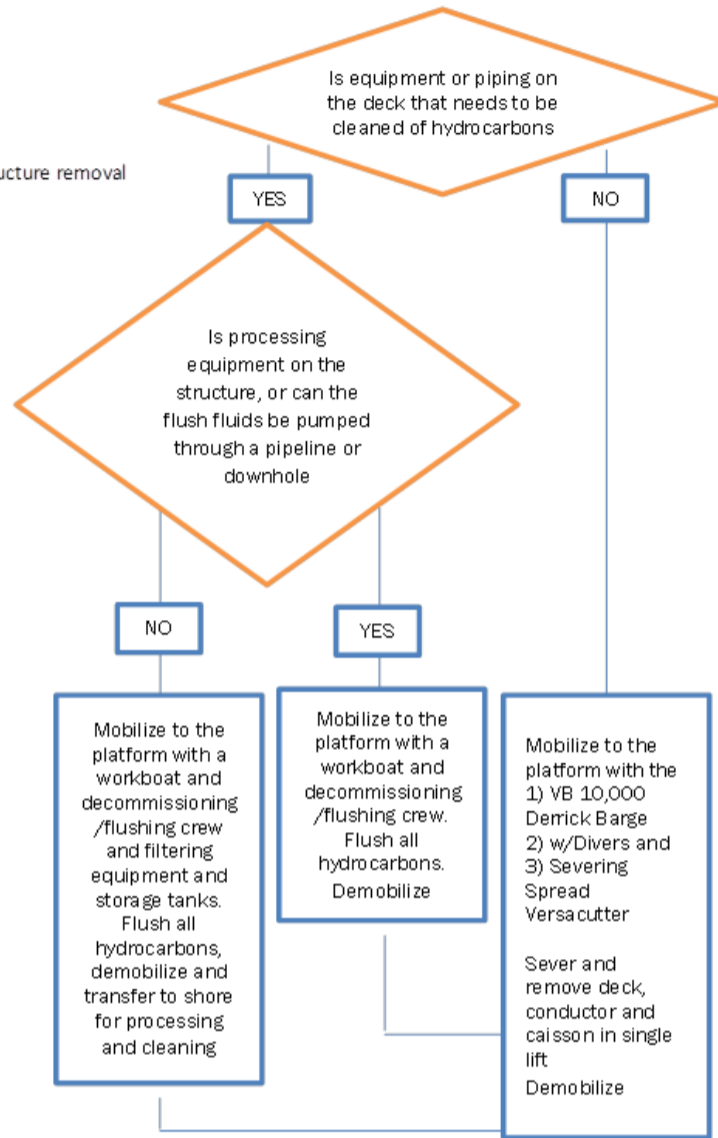

Some overlapping of water depths and diving resources can occur. Water depth/resources here are generalized.

**DIVING SPRED TABLE**  
 WD <120' – Workboat w/Surface Air Divers  
 WD 121'-299' – 4 Point DSV w/Mixed Gas Divers  
 WD 300'-800' – 4 Point or DP11 DSV w/SAT Divers  
 Or ROV with Sonar  
 WD > 801' – ROV with Sonar

**DERRICK BARGE (DB) TABLE**  
 VERSABAR VB 10,000

**SEVERING (CUTTING) TABLE**  
 VERSABAR's Versacutter

LIFT WEIGHT TABLE									
Number of Jacket Legs	Min.*	Deck Wt		Deck Wt T Av.	Jacket Wt		Jacket Wt T Av.	Jacket Wt T Max.	Jacket Wt T Min.
		Min.**	T Max.		T Min.	T Max.			
1 Caisson	50	138	10	139	35	20	200	55	

\* Minimum considered in this study for Federal Waters  
 \*\* Maximum from data available in TSB database  
 T = Tons, AV = Average all structures in the Min. - Max. range

Service provider required information  
 Location  
 Type of Platform (Fixed, Floating)  
 Water Depth (WD) and distance from the water line to the top deck  
 Function of Platform (Drilling/Production/Quarters/Manifold/Wellhead or Protector, Caisson, etc)  
 Number of Deck Legs  
 Number of Jacket Legs  
 Number of Piles and/or Skirt Piles  
 Diameter of piles and wall thickness  
 Equipment installed on deck after deck was installed and lift weights  
 Deck Lift Weight and dimensions for Heavy Lift Vessel (Derick Barge (DB)) selection and Cargo Barge selection  
 Jacket Lift Weight and dimensions for Heavy Lift Vessel (Derick Barge (DB)) selection and Cargo Barge selection  
 Are pile annuluses grouted  
 Are skirt piles grouted inside the pile  
 What are soil conditions at location  
 Pile Severing Method to be used  
 Number of Conductors Present  
 Conductor Severing Method to be used  
 Caisson Severing Method to be used  
 Is Caisson a straight Caisson or a Bottleneck  
 Wells and pipelines are abandoned prior to structure removal

**Fixed Platform Abandonment Flowchart – Braced Caisson**

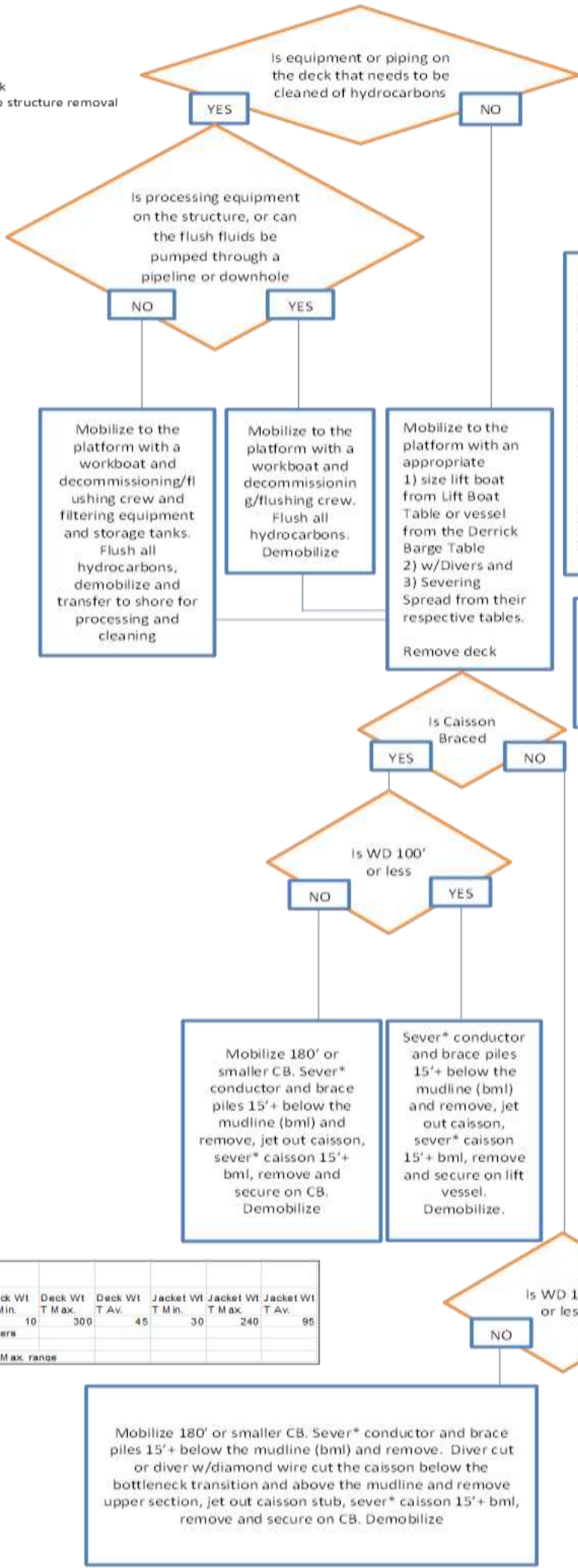

Some overlapping of water depths and diving resources can occur. Water depth/resources here are generalized.

**LIFT BOAT (LB) TABLE**

130 Lift Boat	For use in WD <80' – 50T
145 Lift Boat	For use in WD <95' – 50T
150 Lift Boat	For use in WD <100' – 50T
175 Lift Boat	For use in WD <125' – 75T
200 Lift Boat	For use in WD <150' – 100T
225 Lift Boat	For use in WD <175' – 125T
235-250 Lift Boat	For use in WD <185'-200' – 175T
335 Lift Boat	For use in WD <285' – 250T

For soft soils or mudslide areas, use a higher class LB  
 Liftboat (LB) selection considers WD +10' preload settlement + distance to top of platform

In addition to WD, lifting capacity (crane rating) will need to be considered for the vessel selection. The same size LB for each provider may have different capacities. The lifting capacities in tons (T) listed above are generalized

**DIVING SPRED TABLE**

WD <120'	Workboat w/Surface Air Divers
WD 121'-299'	4 Point DSV w/Mixed Gas Divers
WD 300'-800'	4 Point or DPII DSV w/SAT Divers Or ROV with Sonar
WD > 801'	ROV with Sonar

**DERRICK BARGE (DB) TABLE**

DB 150
DB 250
DB 300
DB 400
DB 500
DB 600/800
DB 2,000 or Greater
VB 10,000
SSCV 7,000
SSCV (2) 7,000
SSCV 9,000

Numbers above reflect lifting capacity in tons. DB will not lift full capacity

**SEVERING (CUTTING) TABLE**

Explosives and Technician(s)\*  
 Abrasive Cutting Spread  
 Mechanical Cutting Spread  
 Diamond Wire Cutting  
 Spread

\*If severing by explosives, National Marine Fishery (NMFS) must be mobilized for dolphin and turtle (Helicopter) watch pre and post detonation

**LIFT WEIGHT TABLE**

Number of Jacket Legs	Min.*		Max.**		Deck Wt T		Jacket Wt T		Jacket Wt T	
	2&3 Braced Caisson	70	250	10	300	45	30	240	95	

\* Minimum considered in this study for Federal Waters  
 \*\* Maximum from data available in TSB database  
 T = Tons, AV = Average all structures in the Min. - Max. range

Service provider required information  
 Location  
 Type of Platform (Fixed, Floating)  
 Water Depth (WD) and distance from the water line to the top deck  
 Function of Platform (Drilling/Production/Quarters/Manifold/Wellhead or Protector, Caisson, etc)  
 Number of Deck Legs  
 Number of Jacket Legs  
 Number of Piles and/or Skirt Piles  
 Diameter of piles and wall thickness  
 Equipment installed on deck after deck was installed and lift weights  
 Deck Lift Weight and dimensions for Heavy Lift Vessel (Derick Barge [DB]) selection and Cargo Barge selection  
 Jacket Lift Weight and dimensions for Heavy Lift Vessel (Derick Barge [DB]) selection and Cargo Barge selection  
 Are pile annuluses grouted  
 Are skirt piles grouted inside the pile  
 What are soil conditions at location  
 Pile Severing Method to be used  
 Number of Conductors Present  
 Conductor Severing Method to be used  
 Caisson Severing Method to be used  
 Is Caisson a straight Caisson or a Bottleneck  
 Wells and pipelines are abandoned prior to structure removal

**Fixed Platform Complete Abandonment Flowchart – 3 Pile or Greater**

For Abandonment By Other Methods, See Artificial Reef Flowchart

Some overlapping of water depths and diving resources can occur. Water depth/resources here are generalized.

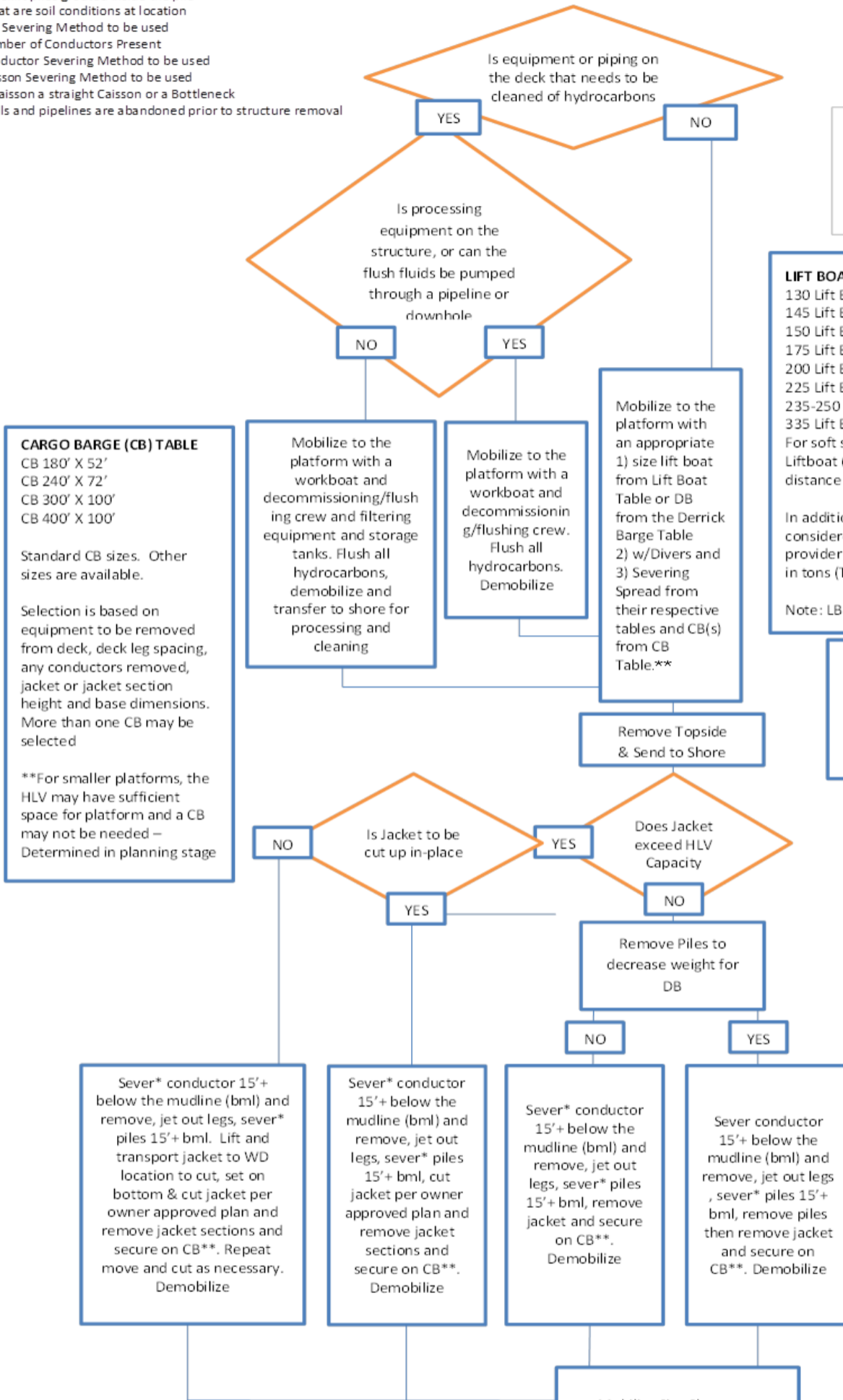

**CARGO BARGE (CB) TABLE**

CB 180' X 52'  
 CB 240' X 72'  
 CB 300' X 100'  
 CB 400' X 100'

Standard CB sizes. Other sizes are available.

Selection is based on equipment to be removed from deck, deck leg spacing, any conductors removed, jacket or jacket section height and base dimensions. More than one CB may be selected

\*\*For smaller platforms, the HLW may have sufficient space for platform and a CB may not be needed – Determined in planning stage

**LIFT BOAT (LB) TABLE**

130 Lift Boat For use in WD <80' – 50T  
 145 Lift Boat For use in WD <95' – 50T  
 150 Lift Boat For use in WD <100' – 50T  
 175 Lift Boat For use in WD <125' – 75T  
 200 Lift Boat For use in WD <150' – 100T  
 225 Lift Boat For use in WD <175' – 125T  
 235-250 Lift Boat For use in WD <185'-200' – 175T  
 335 Lift Boat For use in WD <285' – 250T

For soft soils or mudslide areas, use a higher class LB  
 Liftboat (LB) selection considers WD +10' preload settlement + distance to top of platform

In addition to WD, lifting capacity (crane rating) will need to be considered for the vessel selection. The same size LB for each provider may have different capacities. The lifting capacities in tons (T) listed above are generalized

Note: LB will not lift max weight

**DIVING SPRED TABLE**

WD <120' – Workboat w/Surface Air Divers  
 WD 121'-299' – 4 Point DSV w/Mixed Gas Divers  
 WD 300'-800' – 4 Point or DP/II DSV w/SAT Divers Or ROV with Sonar  
 WD > 801' – ROV with Sonar

**DERRICK BARGE (DB) TABLE**

DB 150  
 DB 250  
 DB 300  
 DB 400  
 DB 500  
 DB 600/800  
 DB 2,000 or Greater  
 VB 10,000  
 SSCV 7,000  
 SSCV (2) 7,000  
 SSCV 9,000

Numbers above reflect lifting capacity in tons

Note: DB will not lift max weight

**SEVERING (CUTTING) TABLE**

Explosives and Technician(s)\*  
 Abrasive Cutting Spread  
 Mechanical Cutting Spread  
 Diamond Wire Cutting Spread

\*If severing by explosives, National Marine Fishery (NMFS) must be mobilized for dolphin and turtle (Helicopter) watch pre and post

LIFT WEIGHT TABLE									
Number of Jacket Legs	Min.*		Max.**		Deck Wt T Av.	Deck Wt T Max.	Jacket Wt T Min.	Jacket Wt T Max.	Jacket Wt T Av.
	28.3 Braced Caisson	70	250	10					
* Minimum considered in this study for Federal Waters									
** Maximum from data available in TSB database									
T = Tons, AV = Average all structures in the Min - Max. range									

Service provider required information

- Location
- Type of Platform (Fixed, Floating)
- Water Depth (WD) and distance from the water line to the top deck
- Function of Platform (Drilling/Production/Quarters/Manifold/Wellhead or Protector, Caisson, etc)
- Number of Deck Legs
- Number of Jacket Legs
- Number of Piles and/or Skirt Piles
- Diameter of piles and wall thickness
- Equipment installed on deck after deck was installed and lift weights
- Deck Lift Weight and dimensions for Heavy Lift Vessel (Derick Barge [DB]) selection and Cargo Barge selection
- Jacket Lift Weight and dimensions for Heavy Lift Vessel (Derick Barge [DB]) selection and Cargo Barge selection
- Are pile annuluses grouted
- Are skirt piles grouted inside the pile
- What are soil conditions at location
- Pile Severing Method to be used
- Number of Conductors Present
- Conductor Severing Method to be used
- Caisson Severing Method to be used
- Is Caisson a straight Caisson or a Bottleneck
- Wells and pipelines are abandoned prior to structure removal

**Fixed Platform Artificial Reef Abandonment Flowchart – 3 Pile or Greater**

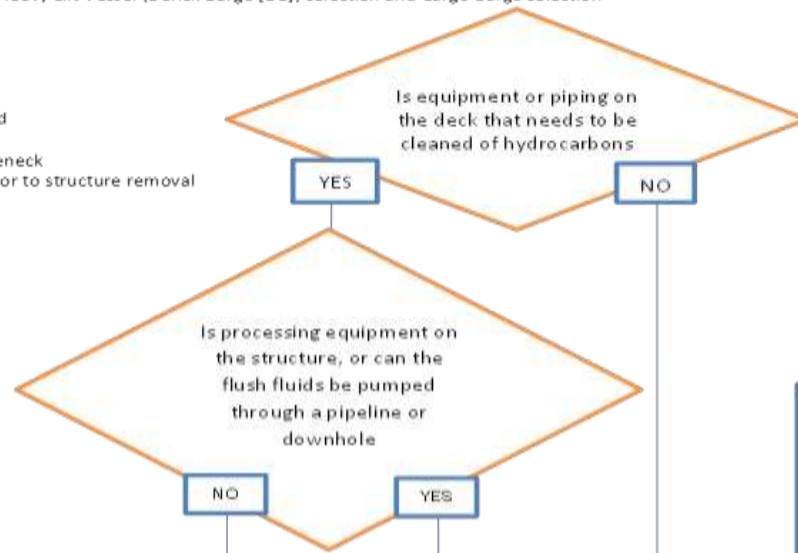

Some overlapping of water depths and diving resources can occur. Water depth/resources here are generalized.

**LIFT BOAT (LB) TABLE**

130 Lift Boat	For use in WD <80' – 50T
145 Lift Boat	For use in WD <95' – 50T
150 Lift Boat	For use in WD <100' – 50T
175 Lift Boat	For use in WD <125' – 75T
200 Lift Boat	For use in WD <150' – 100T
225 Lift Boat	For use in WD <175' – 125T
235-250 Lift Boat	For use in WD <185'-200' – 175T
335 Lift Boat	For use in WD <285' – 250T

For soft soils or mudslide areas, use a higher class LB  
Liftboat (LB) selection considers WD +10' preload settlement + distance to top of platform

In addition to WD, lifting capacity (crane rating) will need to be considered for the vessel selection. The same size LB for each provider may have different capacities. The lifting capacities in tons (T) listed above are generalized

**DIVING SPRED TABLE**

WD <120'	Workboat w/Surface Air Divers
WD 121'-299'	4 Point DSV w/Mixed Gas Divers
WD 300'-800'	4 Point or DP11 DSV w/SAT Divers Or ROV with Sonar
WD > 801'	ROV with Sonar

**CARGO BARGE (CB) TABLE**

CB 180' X 52'
CB 240' X 72'
CB 300' X 100'
CB 400' X 100'

Standard CB sizes. Other sizes are available.

Selection is based on equipment to be removed from deck, deck leg spacing, any conductors removed, jacket or jacket section height and base dimensions. More than one CB may be selected

\*\*For smaller platforms, the HLV may have sufficient space for platform and a CB may not be needed – Determined in planning stage

**DERRICK BARGE (DB) TABLE**

DB 150
DB 250
DB 300
DB 400
DB 500
DB 600/800
DB 2,000 or Greater
VB 10,000
SSCV 7,000
SSCV (2) 7,000
SSCV 9,000

Numbers above reflect lifting capacity in tons

**SEVERING (CUTTING) TABLE**

Explosives and Technician(s)\*  
Abrasive Cutting Spread  
Mechanical Cutting Spread  
Diamond Wire Cutting Spread

\*If severing by explosives, National Marine Fishery (NMFS) must be mobilized for dolphin and turtle (Helicopter) watch pre and post detonation

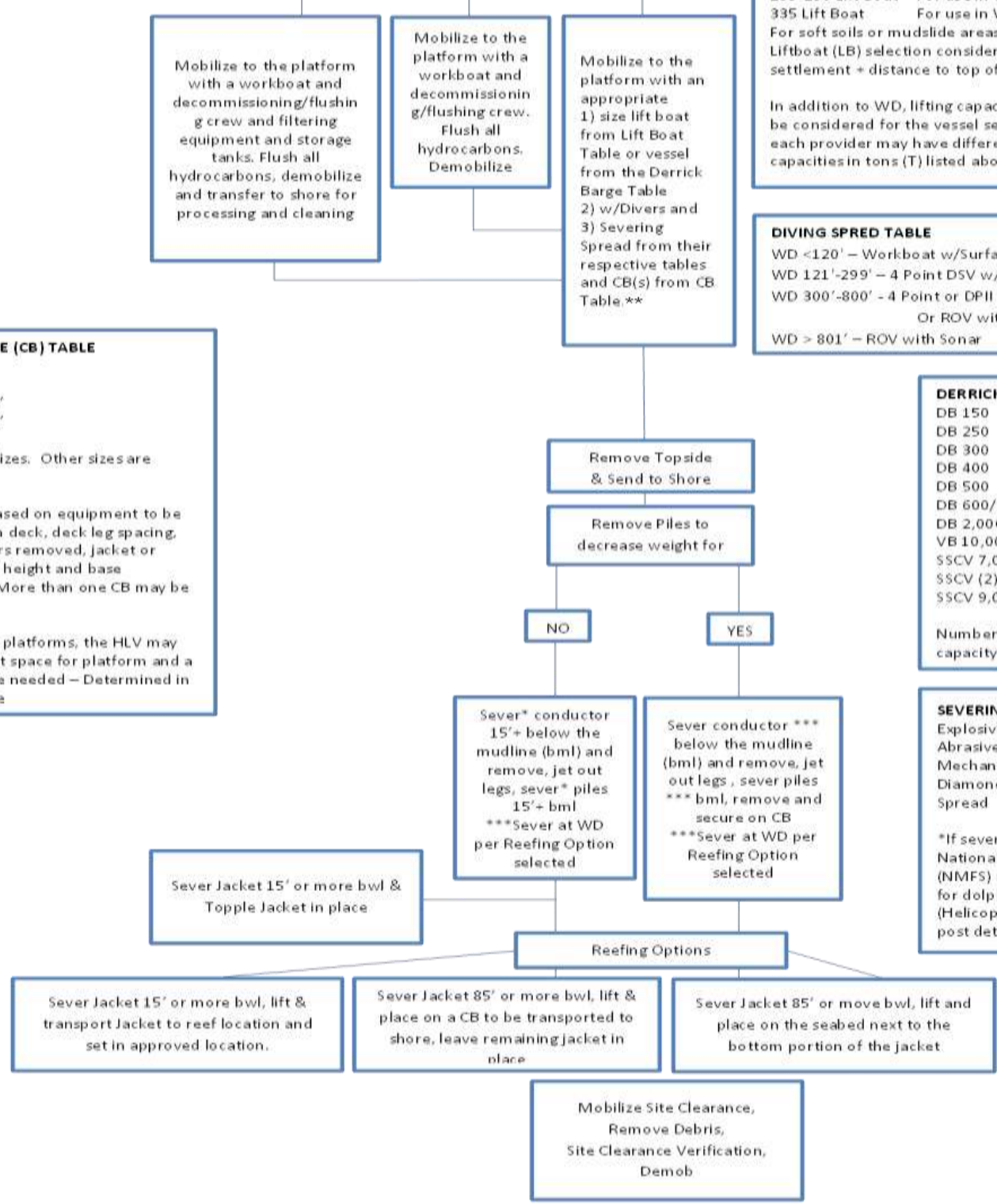



7.6.4.2. Floating Platforms

Service provider required information  
 Location  
 Type of Platform (Floating – Spar, TLP)  
 Water Depth (WD) and distance from the water line to the top deck  
 Function of Platform (Drilling/Production/Quarters/Manifold/Wellhead)  
 Number of Ballast cells  
 Number of tension lines/mooring lines  
 Number of Piles and/or Suction piles  
 Diameter of piles and wall thickness and installation method  
 Equipment installed on deck after deck was installed and lift weights  
 Deck Lift Weight and dimensions for Heavy Lift Vessel [Derrick Barge (DB)] selection and Cargo Barge selection  
 Jacket Lift Weight and dimensions for Heavy Lift Vessel [Derrick Barge (DB)] selection and Cargo Barge selection  
 Are pile annuluses grouted  
 Are skirt piles grouted inside the pile  
 What are soil conditions at location  
 Pile Severing Method to be used  
 Number of Conductors Present  
 Conductor Severing Method to be used  
 Wells and pipelines are abandoned prior to structure removal.

**Floating Platform Complete Abandonment Flowchart – Soar, TLP, mini-TLP.**

For Abandonment By Other Methods, See Artificial Reef Flowchart

Some overlapping of water depths and diving resources can occur. Water depth/resources here are generalized.

**DIVING SPREAD TABLE**

WD <120'	Workboat w/Surface Air Divers
WD 121'-299'	4 Point DSV w/Mixed Gas Divers
WD 300'-800'	4 Point or DP/II DSV w/SAT Divers Or ROV with Sonar
WD > 801'	ROV with Sonar

**DERRICK BARGE (DB) TABLE**

DB 600/800
DB 2,000 or Greater
VB 10,000
SSCV 7,000
SSCV (2) 7,000
SSCV 9,000

Numbers above reflect lifting capacity in tons  
 Note: DB will not lift max weight

**SEVERING (CUTTING) TABLE**

Explosives and Technician(s)*
Abrasive Cutting Spread
Mechanical Cutting Spread
Diamond Wire Cutting Spread

\*If severing by explosives, National Marine Fishery (NMFS) must be mobilized for dolphin and turtle watch watch (onsite and Helicopter observation) pre and post detonation

**CARGO BARGE (CB) TABLE**

CB 180' X 52'
CB 240' X 72'
CB 300' X 100'
CB 400' X 100'

Standard CB sizes. Other sizes are available.  
 Selection is based on equipment to be removed from deck, deck leg spacing, any conductors removed, jacket or jacket section height and base dimensions. More than one CB may be selected  
 \*\*For smaller platforms, the HLV may have sufficient space on its deck for platform and a CB may not be needed – Determined in planning stage

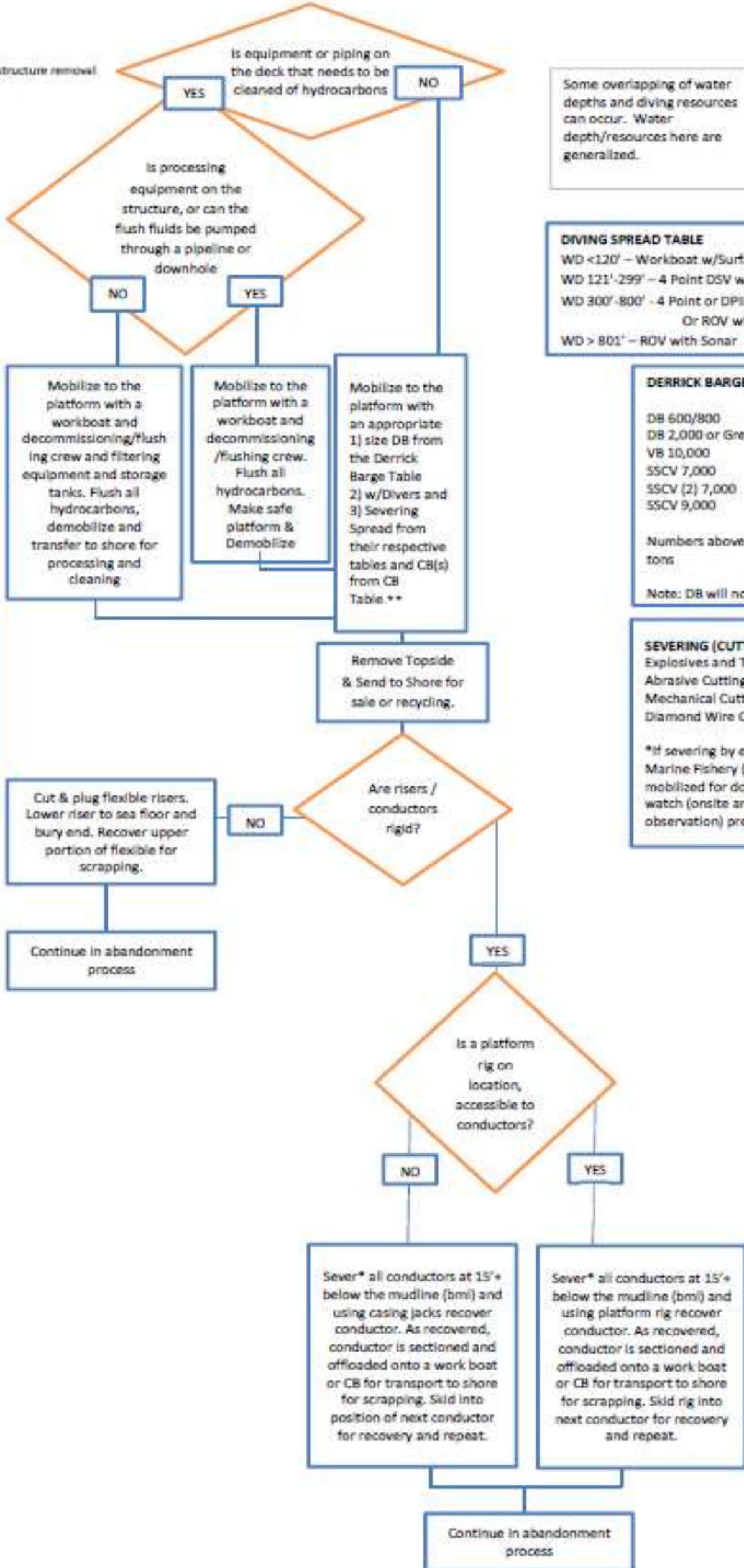

Service provider required information:  
 Location  
 Type of Platform (Floating – Spar, TLP)  
 Water Depth (WD) and distance from the water line to the top deck  
 Function of Platform (Drilling/Production/Quarters/Manifold/Wellhead)  
 Number of Ballast cells  
 Number of tension lines/mooring lines  
 Number of Piles and/or Suction piles  
 Diameter of piles and wall thickness and installation method  
 Equipment installed on deck after deck was installed and lift weights  
 Deck Lift Weight and dimensions for Heavy Lift Vessel (Derrick Barge [DB]) selection and Cargo Barge selection  
 Jacket Lift Weight and dimensions for Heavy Lift Vessel (Derrick Barge [DB]) selection and Cargo Barge selection  
 Are pile annulars grouted  
 Are skirt piles grouted inside the pile  
 What are soil conditions at location  
 Pile Severing Method to be used  
 Number of Conductors Present  
 Conductor Severing Method to be used  
 Wells and pipelines are abandoned prior to structure removal

**Floating Platform Complete Abandonment Flowchart - Continued – Spar, TLP, mini-TLP.**

For Abandonment By Other Methods, See Artificial Reef Flowchart

Some overlapping of water depths and diving resources can occur. Water depth/resources here are generalized.

**DIVING SPREAD TABLE**

WD <120'	Workboat w/Surface Air Divers
WD 121'-299'	4 Point DSV w/Mixed Gas Divers
WD 300'-800'	4 Point or DP11 DSV w/SAT Divers Or ROV with Sonar
WD > 801'	ROV with Sonar

**DERRICK BARGE (DB) TABLE**

DB 600/800
DB 2,000 or Greater
VB 10,000
SSCV 7,000
SSCV (2) 7,000
SSCV 9,000

Numbers above reflect lifting capacity in tons  
 Note: DB will not lift max weight

**SEVERING (CUTTING) TABLE**

Explosives and Technician(s)*
Abrasive Cutting Spread
Mechanical Cutting Spread
Diamond Wire Cutting Spread

\*If severing by explosives, National Marine Fishery (NMFS) must be mobilized for dolphin and turtle (Helicopter) watch pre and post

**Towing SPAR**  
 Towing of a SPAR will require installation of flotation devices. This is conceptual only and has not been used in practice.

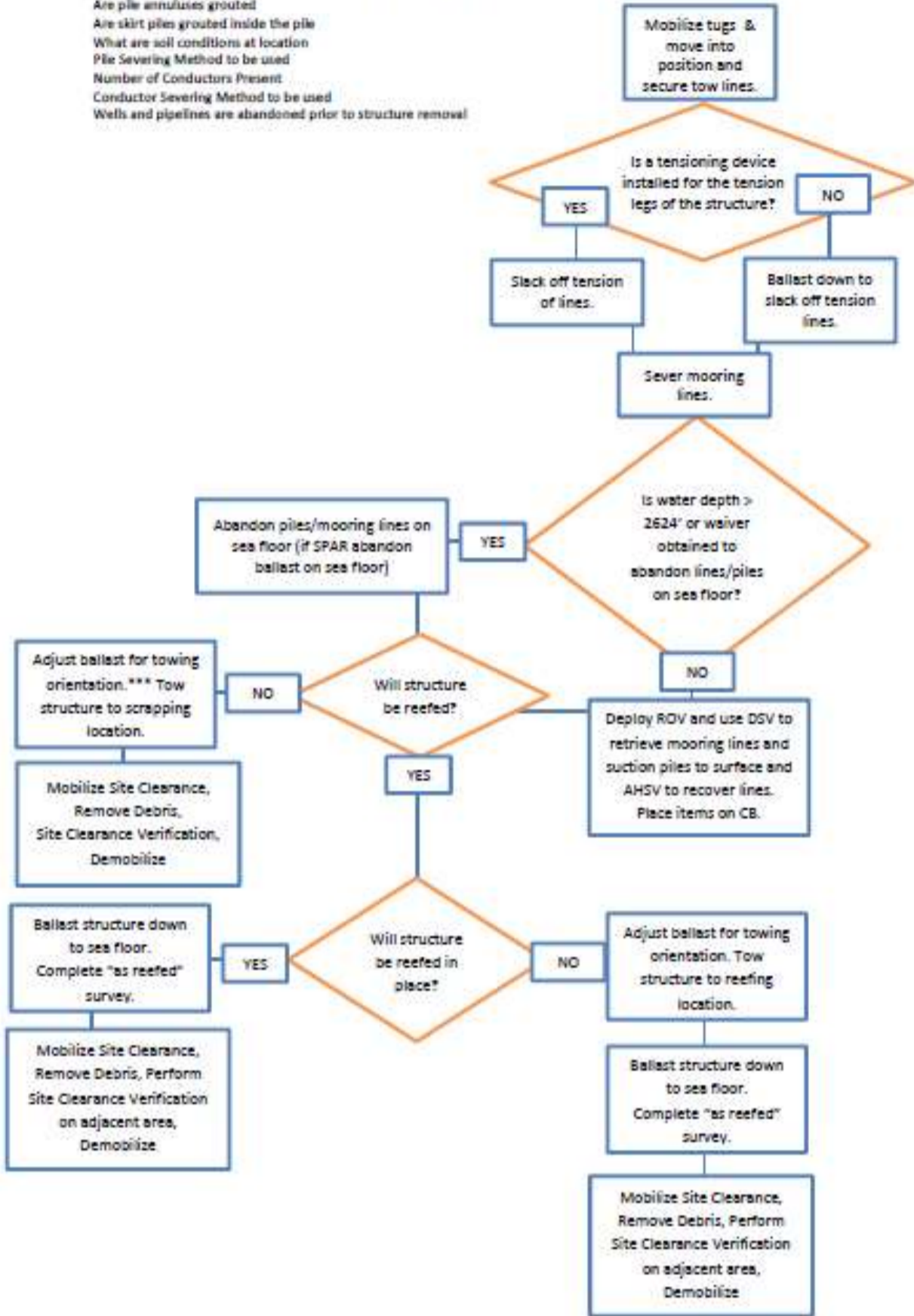

### 7.6.5. Subsea Structure Decommissioning

**Following Information Service provider needs to know**  
 Equipment flushed with pipeline abandonment previously.  
 Field Location  
 Water Depth (WD)  
 Structure to remove  
 Weight/support of structure  
 Hours of operations:  
 12 Hrs. - 5 man crew & supervisor (Generalized as each provider is different)  
 24 Hrs. - 10 man crew & 1 or 2 Supervisors  
 Equipment weight & dimension (Equipment Load out Sheet)  
 Any known sea floor issues will dictate extra equipment, personnel, duration  
 What is the maximum lift weight to pull (pilings, manifold, PLET, etc...)

#### Subsea Structure Abandonment

**DERRICK BARGE (DB) TABLE**

DB 150
DB 250
DB 300

Numbers above reflect lifting capacity in tons

**LIFT BOAT (LB) TABLE**

130 Lift Boat	For use in WD <80' - 50T
145 Lift Boat	For use in WD <95' - 50T
150 Lift Boat	For use in WD <100' - 50T
175 Lift Boat	For use in WD <125' - 75T
200 Lift Boat	For use in WD <150' - 100T
225 Lift Boat	For use in WD <175' - 125T
235-250 Lift Boat	For use in WD <185'-200' - 175T
335 Lift Boat	For use in WD <285' - 250T

For soft soils or mudslide areas, use a higher class LB  
 Liftboat (LB) selection considers WD +10' preload  
 settlement + distance to top of platform

In addition to WD, lifting capacity (crane rating) will need to be considered for the vessel selection. The same size LB for each provider may have different capacities. The lifting capacities in tons (T) listed above are generalized. Note: LB will not lift max weight

**DIVING TABLE**

WD <120'	- Surface Air Divers
WD 121'-299'	- Mixed Gas Divers
WD 300'-800'	- Saturation Divers
WD > 800'	- ROV only

Diving depths are generalized

**SEVERING (CUTTING) TABLE**  
 Explosives and Technician(s)\*  
 Abrasive Cutting Spread  
 Mechanical Cutting Spread  
 Diamond Wire Cutting Spread

\*If severing by explosives, National Marine Fishery (NMFS) must be mobilized for dolphin and turtle (Helicopter) watch pre and post detonation

**Diving Support Vessel (DSV) TABLE**

4 point moored	- 50 mT
DP DSV	- 150 mT AHC crane lift capability

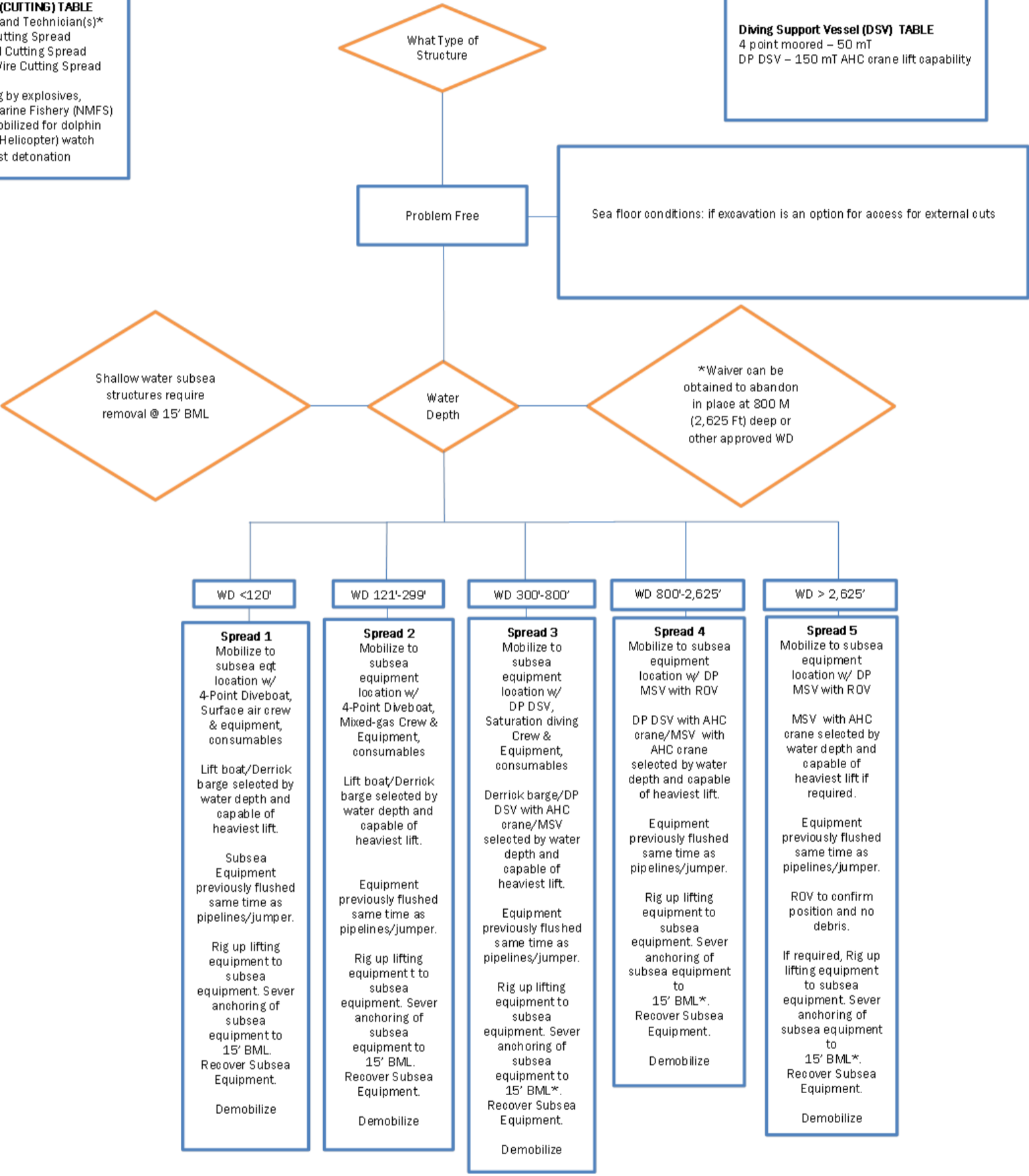

## 8. Decommissioning Costs

### 8.1. Introduction

This Section presents cost data to determine estimated decommissioning liabilities for typical fixed, tethered and moored structures along with associated pipelines and wells. Because virtually all offshore decommissioning in the US OCS has been done in the GOM OCS, the cost data presented reflects GOM OCS experience only. To estimate decommissioning costs in other areas, a similar procedure would be used to build up the total estimated cost but site specific costs would need to be determined for each activity. Piece small removal and other unconventional methodologies are not considered in this project due to lack of confidence in cost estimation accuracy<sup>10</sup>, but there has been indications that piece small removal could be approximately 50% - 100% higher than conventional methodology<sup>11</sup>.

The estimates were developed in a manner that satisfies the reporting and audit requirements of Financial Accounting Standards Board (FASB) Statement of Financial Accounting Standards No. 143, "Accounting for Asset Retirement" (SFAS 143); i.e., what a willing third party would consider in today's costs with no future adjustments. This standard requires that scrap values, if any, be treated separately from decommissioning costs for accounting purposes. The estimates presented here do not attempt to estimate salvage or scrap values.

The costs included in this study are a snapshot-in-time, based on available information and resources economically selected for use. All costs in this section are estimated assuming trouble-free operations and have not considered sharing of resources or using new emerging technology. All resource costs are for the GOM. Costs for other areas will be different.

The intent of this section is not to develop the decommissioning cost for a specifically named platform but rather to identify the costs for a type of facility in a particular water depth and provide the opportunity for the viewer to obtain similar cost conclusions. Therefore, where costs are included, for simplicity and confidentiality the platform names / locations have been omitted. Since each facility will have different quantities of wells and pipelines, the estimated costs are provided separately on a unit basis. Backup data for the representative platform deterministic estimates are provided in the Appendix.

There have only been 16 platforms removed from the GOM in water deeper than 400 ft in the last 20 years. This includes two Semisubmersibles, one MTLP, one Spar and twelve fixed platforms. During the same time period 3,304 structures were removed from water depths less than 400 ft. Industry estimates of platform removals from water deeper than 400 ft are based primarily on projections due to this limited data compared to the abundance of data from shallower removals. Decommissioning service

---

<sup>10</sup> <http://decomnorthsea.com/uploads/pdfs/projects/ABB-Offshore-Oil-and-Gas-Decommissioning-2015.pdf>

<sup>11</sup> [https://www.gov.uk/government/uploads/system/uploads/attachment\\_data/file/43411/inde-dp\\_1\\_.pdf](https://www.gov.uk/government/uploads/system/uploads/attachment_data/file/43411/inde-dp_1_.pdf)

companies agree that decommissioning costs will rise steeply as decommissioning activities move to deeper waters. Table 8-1 lists the total number of platforms removed in the GOM OCS since 1995.

**Table 8-1. Platforms Removed in the GOM**

<b>Structure Type</b>	<b>0' to 400'</b>	<b>401' to 800'</b>	<b>801' to 2,000'</b>	<b>&gt; 2,000'+</b>
Caisson	1,338	0	0	0
CT	0	0	0	0
Fixed	1,573	12	0	0
FPSO	0	0	0	0
MOPU	3	0	0	0
MTLP	0	0	0	1
SEMI	0	0	0	2
Spar	0	0	0	1
TLP	0	0	0	0
WP	390	0	0	0
<b>Totals</b>	<b>3,304</b>	<b>12</b>	<b>0</b>	<b>4</b>

## 8.2. Parameters Affecting Decommissioning Costs

This section presents parameters that have an impact on offshore decommissioning costs, for the following tasks:

- Well Plugging and Abandonment
- Pipeline Decommissioning
- Umbilical Decommissioning
- Conductor Removal
- Platform Decommissioning
- Subsea Structure Decommissioning
- Site Clearance and Verification
- Material Disposal

The availability of decommissioning resources and the location from which they must mobilize impact the mobilization and demobilization costs of all of the tasks. Reduced costs can be achieved by using resources that are already working in or near the same offshore area. This is commonly referred to as a “fly by”, where the resource would finish or stop work at one location and move directly to a nearby location. The operators of both locations realize savings on mobilization and demobilization costs.

Each section below lists the most significant variables that impact the cost to perform the task.

### 8.2.1. Well Plugging and Abandonment

- The number of wells to P&A on a platform or multiple platforms
- The per/well cost for mobilization is reduced as the number of wells increase.

- The condition of the well dictates the resource spread required. Lower costs result from using a rigless spread on a trouble free well; higher costs result if a drilling rig is needed for a problem well.
- The number of producing zones that must be plugged and the number of strings – Single, Dual or Triple Completion –dictate the duration of the work and the amount of consumables used.

### 8.2.2. Pipeline Decommissioning

- Mobilization and demobilization distance
- Water depth
- Type of diving spread (air, mixed gas or SAT) or ROV spread
- Type of vessel required (Work boat, 4-Point dive boat, Dynamic Positioning or Intervention)
- Pipeline termination point (Riser to Riser, Riser to Subsea Tie-in (SSTI), SSTI to Riser or SSTI to SSTI)
- Direction of the pipeline i.e. incoming (KAQ), outgoing (KAH), or bi-directional (KAA). The direction of the pipeline determines the valve locations - most importantly the check valve location. A pipeline can be pigged or flushed only in the direction of flow allowed by the check valve. For example, an incoming pipeline cannot be pigged from the platform to the SSTI because the check valve only allows flow from the SSTI to the platform.
- A pipeline with a check valve can be pigged or flushed in the opposite direction if the valve can be pinned open, but the only way to insure the valve can be pinned open is to cycle the valve. For a subsea valve, this requires the use of divers for a pre-job inspection and significantly raises the cost of the operation
- Flushing volume (250% of the pipeline volume) or pigging volume (100% of the pipeline volume)
- Flushing flow rate
- If the line is sanded up, has significant paraffin build up, or has damage from an anchor, pigging may not be an option.
- Pipeline water depth and end points impact the vessels and divers or ROV used.
- Estimated pipeline decommissioning costs for bonding purposes should include flushing of the pipeline to 250% of the line volume because it may not be known if the valves are operable or what the flow direction of the pipeline is. Flushing increases the duration of the flushing operation, which increases the cost.

Pipelines include the injection and disposal risers on floating or tensioned leg platforms.

### 8.2.3. Umbilical Decommissioning

- Mobilization and demobilization distance
- Water depth
- Type of diving spread (air, mixed gas or SAT) or ROV spread
- Type of vessel required (Work boat, 4-Point dive boat, Dynamic Positioning, Intervention or AHV with reels for umbilical)
- Umbilicals that are fluid control need to be flushed; electrical umbilicals do not
- Whether the umbilical to be abandoned in place or removed

- If the umbilical is not to be abandoned in place, the lifting weight, length and water depth must be known for resource selection.

#### 8.2.4. Conductor Removal

- Removal of conductors during platform removal operations with the DB or prior to the arrival of the DB. For deeper platforms, with many conductors, it is more cost effective to mobilize a severing and removal spread prior to the DB arrival.
- The conductor severing method - The lowest cost method is often severing with explosives. However, delays are possible if protected marine life is found in the area.
- If the conductor must be pulled through bell guides, explosive methods may flare the end and prevent the conductor from passing through the guide. Abrasive or mechanical methods would be preferred in this case.
- If the platform does not have a crane of sufficient lift capacity, a portable crane must be installed or casing jacks must be included in the work spread.
- Conductor characteristics must be known for cutting method selection –
  - Conductor Diameter,
- Number of casing strings to be removed with the conductor,
  - Whether casing strings are grouted, and
  - Casing string diameter(s).

#### 8.2.5. Platform Decommissioning

##### 8.2.5.1. Fixed Platforms

- Mobilization and demobilization distance
- Water depth
- Type of diving spread (air, mixed gas or SAT) or ROV spread
- Any equipment or modifications added to the deck after deck installation must be reviewed as this changes the original center of gravity (COG) and lifting design
- All processing equipment and piping must be cleaned with all fluids processed either by onboard process equipment, by processing equipment mobilized to the site, or by capturing in tank for onshore processing
- Deck and jack dimensions and lift weights must be known for DB and CB(s) selection
- Whether the deck is planned to be cut up and removed in multiple lifts, e.g., 8-leg deck into two 4-leg decks
- If the piles are to be removed to reduce the jacket lift weight, explosive methods may flare the end and prevent the pile from passing through the jacket leg. Abrasive or mechanical methods would be preferred in this case

- If the piles have internal obstructions that would prohibit the use of internal severing tools, the piles must be cut from the outside with DWC. Jetting tools assisted by divers or ROV will need to jet out around each pile to place the DWC at the approved cutting depth BML.
- If the jacket pile to leg annulus has been grouted, the piles cannot be removed and must be included in the jacket lift weight calculations
- Jacket final disposition - complete removal or reefing method
- Jacket lifting and or cutting method must be determined, e.g., single lift, multiple lift, severing BWL or hopping and severing AWL

#### 8.2.5.2. Floating Platforms

- Mobilization and demobilization distance
- Water depth
- Type of diving spread (air, mixed gas or SAT) or ROV spread
- Whether the deck needs to be removed
- All processing equipment and piping must be cleaned with all fluids processed either by onboard process equipment, by processing equipment mobilized to the site, or by capturing in tank for onshore processing
- Number and type of lift weights of the mooring lines in the anchoring system, i.e. steel, polymer or other cable, chain or a combination
- If a TLP or MTLP, the number of steel pipes and the associated lift weights
- Whether the anchor piles are to be removed or left in-place
- Whether the anchoring system is to be removed or left in-place
- The mooring to pile or tension leg to pile severing method
- Whether the moorings must be severed from the hull or can be released
- The mooring to hull or tension leg to hull severing method
- The lift capacity of the DP HLV and CB selected affects the anchoring system sectioning and removal plan
- The number of tow tugs required to be transport the hull to a new location, refurbishing yard, or scrap facility

#### 8.2.6. Subsea Structure Decommissioning

- Mobilization and demobilization distance
- Water depth
- Type of diving spread (air, mixed gas or SAT) or ROV spread
- Whether the subsea structures, PLETs, PLEMs, UTAs, jumpers, etc., will be removed or left in-place
- Whether the structures are directly anchored to the seabed or installed over anchored templates
- Whether the templates will be removed or approved to be left in-place
- The method of severing any anchor piles
- If the structures are removed, the dimensions, lift weights and water depth will drive the choice of removal spread



### 8.2.7. Site Clearance and Verification

- Mobilization and demobilization distance
- Water depth
- Whether trawling is required
- Whether an alternate method is approved
- Age of platform – In general the older the platform, the more debris

### 8.2.8. Material Disposal

There are three primary methods of disposal for steel and other materials associated with dismantling a platform: refurbish and reuse, scrap and recycle, and dispose of in designated landfills. Opportunities for refurbishing and reusing facilities are very limited due to the limitations associated with meeting the strict technical standards now required, so most material is recycled.

There are quite a number of steel scrap yards along the Gulf Coast that receive production equipment from decommissioned offshore production facilities. Scrap steel recycling is a big business, as platforms, pipelines, floating production systems, and subsea production systems are brought ashore. During the year 2007, scrap steel delivered to the dock in Morgan City, Louisiana was sold to scrap dealers for about \$300 per ton. The year 2008 saw a collapse in the scrap steel market, and scrap yards charged contractors \$75 per ton to unload steel platforms. In 2015 scrap steel is bringing \$70 to \$130 per ton at the dock in Morgan City. Scrap may also be exported to China, India, South Korea, Turkey or other countries, depending on market prices.

The scrap yards receiving large components must process the material by cutting it into smaller pieces, typically 2' x 5' maximum, to meet the size requirements of secondary smelters. The value of the large pieces may be \$150/ton to \$200/ton less than the spot price of scrap steel at the mill to account for this processing and transportation. Therefore, when steel prices are high, the offshore components may yield a profit when delivered to the scrap yard but when steel prices are low the scrap yard may charge to accept the steel. The scrap metal must be sorted to separate galvanized steel, stainless steel, and other metals from carbon steel.

Southern Recycling on the water front in Morgan City, Louisiana has been in the platform recycling business for over 40 years, and they have been recycling since 1902. Pictures of this scrap yard are shown in Figure 8-1 and Figure 8-2. Their 400 ton lift capacity crane unloads offshore platforms in large pieces, which are then cut up for shipment to the steel mills. Southern Recycling places some high value offshore platforms in storage with their joint venture partner Allison Marine for possible reuse as an offshore production platform.



Figure 8-1. Southern Scrap Yard Morgan City

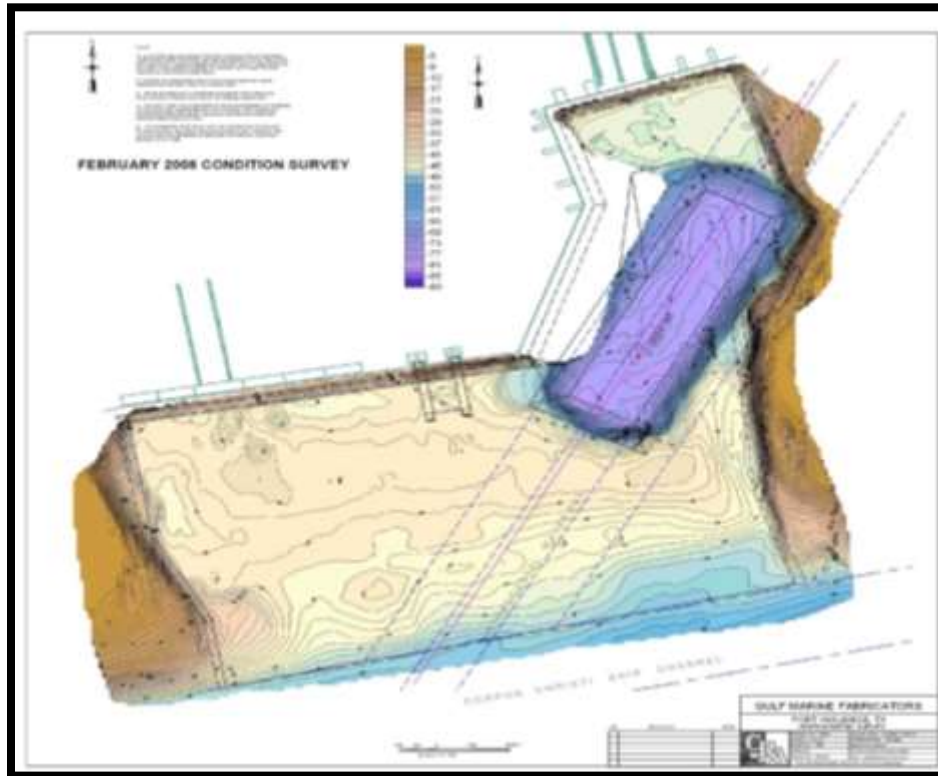

Figure 8-2. Southern Scrap Yard  
(Photo courtesy of Southern Scrap)

There are numerous other sites along the gulf coast of varying sizes that could be used as scrap facilities. The Gulf Marine Fabricators facility in Ingleside, Texas, though not configured as a scrap facility, could also be used as a disposal site or a site to reconfigure jackets for further use. See Figure 8-3 and Figure 8-4. The draft requirements would allow use of flotation devices and floating the jackets to their deep water facility for some of the jackets included in this study. For the larger ones, this would not be an option. For example, the Bullwinkle structure in 1,348' water depth has a jacket base dimension of 300' X 350' and even partially submerged using flotation devices, the structure would exceed the 45' minimum channel draft.



**Figure 8-3. Gulf Marine Fabricators Yard**  
(Photo courtesy of Gulf Marine)



**Figure 8-4. Gulf Marine Fabricators**  
(Drawing courtesy of Gulf Marine Fabricators)

### 8.3. Estimated Costs

This section presents estimated costs for each major component of decommissioning. Each subsection provides a description and either a stated cost or table(s) from which the user can select costs.

- Engineering and Project Management
- Well Plugging and Abandonment
- Pipeline Abandonment
- Umbilical Decommissioning
- Conductor Decommissioning
- Platform Decommissioning
  - Fixed Platforms
  - Floating Platforms

#### 8.3.1. Planning, Engineering, Project Management, Weather Contingency and Work Provision

Costs for planning, engineering, project management, weather contingency and work provision are not usually calculated directly but are estimated as percentages of the directly estimated costs.

### **8.3.1.1. Planning, Engineering, Project Management**

The project management, engineering and planning phase of the decommissioning process will typically need to begin at a minimum of two to three years before production ceases and involves a review of contractual obligations, engineering analysis, operational planning, and contracting. These would be in-house operator costs with cost input from service providers. The first step involves conducting a detailed review of all records and decommissioning requirements including lease, operating, production/unit, pipeline, and production sales agreements. A detailed engineering analysis is also conducted of drilling records, as-built drawings, construction reports, maintenance records and inspection reports. Field inspections are done to verify the structural integrity of the platform and examine the present condition of the wellheads and equipment. Based on this information, detailed engineering plans are developed for plugging and abandoning the wells, decommission the pipelines, severing the conductors and piles, removing the conductors, removing the piles if necessary, removing the topsides and jacket, and disposing of the materials. Concurrently, a comprehensive survey of decommissioning vessels and equipment is made to determine their availability and cost. Bids are then solicited and contractors selected.

The costs of project management, engineering and planning for decommissioning an offshore structure can vary widely, depending on the corporate structure, type of platform, its size, water depth, removal procedures, and transportation and disposal options. For the actual offshore work an analysis of historical decommissioning costs over a 30 year period yielded an approximate 8% cost for Project Management and Engineering (Eng/PM). This is in line with multiple evaluations of decommissioning projects where the percentage of operator costs for Operator Project Management is reported at 8%. The Eng/PM costs are based on the subtotal with the Mob/Demob costs. The cost information was obtained from a TSB in-house database that compiles cost data on oil and gas platform decommissioning projects in the Gulf of Mexico. The operator up-front planning and operational monitoring is not included in this 8% and would be an additional estimated 3%-4% for a small project like a caisson removal to 1%-1.5% for a large fixed platform in deep water. This is based on TSB experience and is not based on operator input as operators hold this information confidentially. If an operator were to go out of business and no other operators were liable for the ARO, BSEE would incur this cost either directly or through a third party.

### **8.3.1.2. Weather Contingency Allowance**

A weather allowance (often referred to as contingency) of 20% is used in the estimates in this study. See Chapter 9 for a discussion of Contingency. Weather allowance cost is based on the subtotal without the Mob/Demob and is based on vessel on-location costs.

### **8.3.1.3. Work Provision**

A work provision of 15% is included in the estimates in this study. TSB's Platform Abandonment Estimating System (PAES®) program used to generate the estimates in this study has historically been benchmarked against actual decommissioning projects in the GOM that TSB has managed or performed.

Since the development of the PAES® program and during the benchmarking phase, the actual total decommissioning costs have consistently been about 15% over the estimated cost of the major decommissioning activities. This 15% has not been allocated to the numerous individual tasks involved in virtually hundreds of decommissioning scenarios, but is included as a line item in the estimates to capture these industry costs. This is not extra work or work contingency, but includes activities necessary for actual removals that are not currently itemized in the estimates. Work Provision cost is based on the subtotal without the Mob/Demob costs.

### 8.3.2. Well Plugging and Abandonment

#### 8.3.2.1. Dry Tree Wells, Water Depth 50 ft to 400 ft

For the purpose of this study, it was assumed that the well casings were grouted to the surface, the 9-5/8" and smaller strings were pulled during Temporary Abandonment (T&A) operations, and the remainder were pulled during conductor severing and removal. Typically the well abandonment is completed in the T&A stage and the conductors are severed and removed during platform removal operations using a DB. The well abandonment costs in this study are for T&A operations; the conductor costs are estimated elsewhere in this study. The wells were estimated as typical trouble-free wells plugged using rigless methods. Additional costs due to well abandonment complications such as stuck valves, collapsed casing, or fouling with sand, paraffin, or other materials are highly dependent on the individual well circumstances and require evaluation of the current well bore schematics and well history. Costs associated with problematic wells are outside the scope of this study.

Operators need to confirm if wells can be accessed with rigless methods or require other methods. The estimates here are generic and include the work provision, weather and engineering percentages as discussed earlier in this chapter. The estimates presented are for trouble-free wells using rigless methods from the platform.

For wells on platforms in WDs of 50' to 400', a representative platform in the midrange of 200' WD was selected with a mobilization distance of 103 NM using a workboat at 8 knots per hour plus 12 hours dock time. Table 8-2 shows the range in costs on this platform with for configurations with from 1 well up to 20 wells. The total estimated costs are plotted in Figure 8-5 and the estimated per well costs are plotted in Figure 8-6.

The estimated cost is built up from the unit costs of individual components and needs to be adjusted for the specific circumstances of each platform and project. The equations below illustrate the components that go into the formula for a representative well P&A cost estimate. The specific values will depend on the spreads used in the estimates.

$$\begin{aligned} \text{Cost} = & \text{Mobilization cost} + \text{Setup cost} + \text{P\&A cost} + \text{Rig down cost} + \text{Demobilization cost} \\ & + \text{Work provision} + \text{Weather contingency} \\ & + \text{Engineering/Project Management cost} \end{aligned}$$

$$\text{Mobilization cost} = \text{Workboat hourly rate} * (12 \text{ hr} + \text{Mob distance}/\text{boat speed})$$

$$\text{Setup cost} = \text{Setup hourly rate} * 4 \text{ hr/well} * \text{No. of wells}$$

$$\text{P\&A cost} = \text{P\&A hourly rate} * 84 \text{ hr/well} * \text{No. of wells}$$

$$\text{Rig down cost} = \text{Rig down hourly rate} * 4 \text{ hr/well} * \text{No. of wells}$$

$$\text{Demobilization cost} = \text{Workboat hourly rate} * (12 \text{ hr} + \text{Mob distance}/\text{boat speed})$$

$$\text{Eng/PM cost} = 8\% * (\text{Mob cost} + \text{Setup cost} + \text{P\&A cost} + \text{Rig down cost} + \text{Demob cost})$$

$$\text{Weather contingency} = 20\% * (\text{Setup cost} + \text{P\&A cost} + \text{Rig down cost})$$

$$\text{Work provision} = 15\% * (\text{Setup cost} + \text{P\&A cost} + \text{Rig down cost})$$

**Table 8-2. Dry Tree Well T&A in WD 50' to 400'**

Task	20 Wells		15 Wells		10 Wells		5 Wells		1 Well	
	Hours	Cost	Hours	Cost	Hours	Cost	Hours	Cost	Hours	Cost
Mob P&A Spread (Hr) #24	25	\$37,743	25	\$37,743	25	\$37,743	25	\$37,743	25	\$37,743
Setup on Platform & All Wells (Hr) #11	80	\$121,360	60	\$91,020	40	\$60,680	20	\$30,340	4	\$6,068
P&A Wells on Platform (Hr) #28	1680	\$4,517,120	1260	\$3,387,840	840	\$2,258,560	420	\$1,129,280	84	\$225,856
Rig Down from All Wells & Platform (Hr) #12	80	\$121,360	60	\$91,020	40	\$60,680	20	\$30,340	4	\$6,068
Demob P&A Spread (Hr) #25	25	\$37,743	25	\$37,743	25	\$37,743	25	\$37,743	25	\$37,743
Work Provision - 15% (w/o Mob/Demob)		\$713,976		\$535,482		\$356,988		\$178,494		\$35,699
Weather Contingency - 20% (w/o Mob/Demob)		\$951,968		\$713,976		\$475,984		\$237,992		\$47,598
Engineering & PM - 8% (w/ Mob/Demob)		\$386,826		\$291,629		\$196,432		\$101,236		\$25,078
<b>Total All Wells</b>		<b>\$6,888,096</b>		<b>\$5,186,453</b>		<b>\$3,484,810</b>		<b>\$1,783,168</b>		<b>\$421,853</b>
<b>Cost per Well</b>		<b>\$344,405</b>		<b>\$345,764</b>		<b>\$348,481</b>		<b>\$356,634</b>		<b>\$421,853</b>

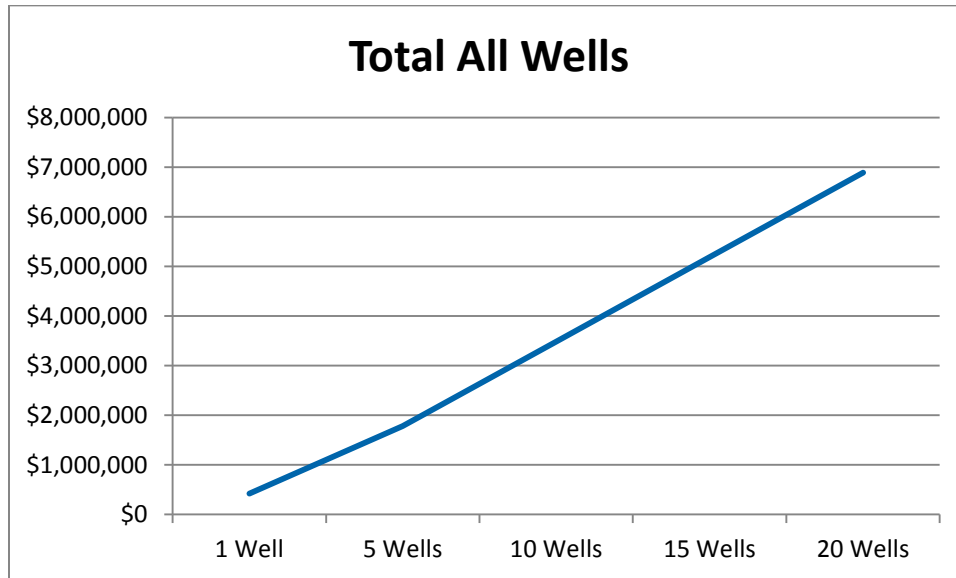

Figure 8-5. Total Well Costs

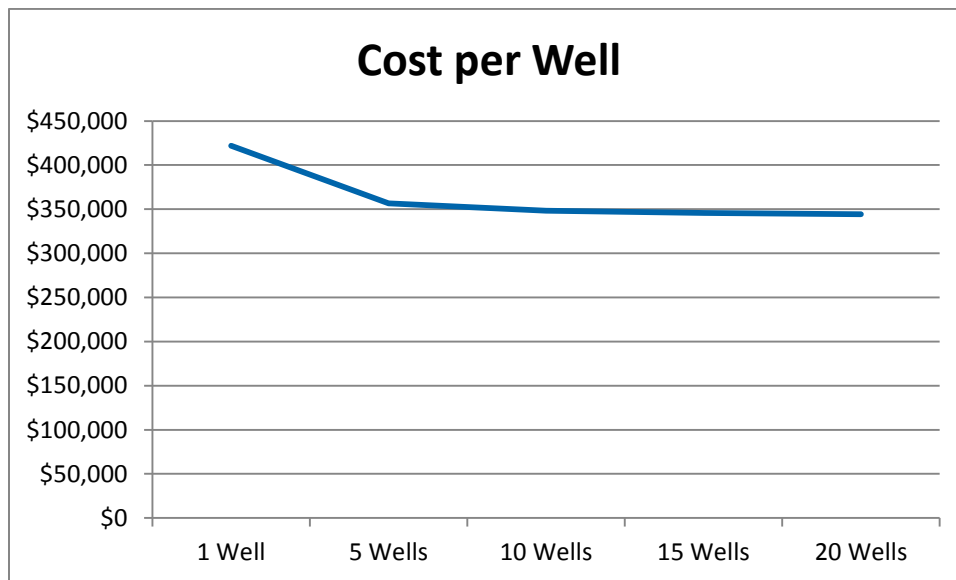

Figure 8-6. Per Well Costs

### 8.3.2.2. Dry Tree Wells, Water Depth over 400 ft

The typical platform crane of 25 tons is insufficient to pull the 9-5/8" casing on platforms in water depths greater than 400 ft, therefore all strings were estimated to be pulled with casing jacks. The typical T&A spread and operation durations are shown in Table 8-3 for problem free, accessible, dry tree wells.



Table 8-3. Well T&amp;A Basic Parameters with Casing Jacks

FIXED PLATFORM									
T&A equipment and personnel per day*	\$36,000	Casing Jack / day			P&A Platform Support Equip. per Day	Support Vessel X2 per Day	Casing Jack Spread /Day	Total Spread / Day	
Consumables per well	\$55,000	Tons	Rental	Jacking Specialist 24 hr**	per Day	per Day	per Day		
Subtotal	\$91,000	300	\$1,608	\$1,608	\$6,000	\$24,816	\$1,608	\$68,424	
Assumed freeboard ft	78				\$250	\$1,034			
Cut bmi for surface plug ft	450			** Jack Specialists not included, as P&A crew are familiar with Jacks					
String cut length ft	40								
Duration per cut&pull hr	1.5								
Typical T&A hr	60							Total Spread / Day	
Ratio T&A to Cut and pull	60:40							\$36,000	
% T&A	60							\$1,608	
% Cut and pull	40							\$6,000	
% pull w/jacks	50							\$24,816	
T&A and cut & pull w/o jacks hr	48							\$68,424	
* Using 10K psi pump @ 24 hr / day									
Well count*	60								
Work Provision %	15								
Weather %	20								
Engineering %	8								

The cost to T&A dry tree wells at water depths from 400' to 5,000' were estimated for a platform with 60 wells as shown in Table 8-4. Mobilization duration is based on distances to average water depth curves using a workboat at 8 knots per hour plus 12 hours dock time. Fixed platforms have dry tree wells in water depths from 400' to about 1,800'. TLPs have dry tree wells in water depths from about 1,500' to >4,600'. The costs were estimated at well counts from 1 to 60 wells and then normalized to the cost per well. Figure 8-7 shows the cost per well as a function of water depth and number of wells on a platform. The mobilization and demobilization costs are distributed among all of the wells. Table 8-4 shows the well P&A costs for various platforms with 60 wells.

Well T&A costs for platforms with other well counts in varying water depths can be obtained from either Figure 8-7 or Figure 8-8. For example the cost of 60 platform wells in 1,800' in Table 8-4 is \$45 MM. Using Figure 8-7 at 1,800' the 60 well curve shows \$754K per well. Multiplying this times 60 wells equals \$45 MM. Using Figure 8-8 at 1,800' the 60 well curve shows a unit cost of \$419 per foot of water depth per well. Using \$419/ft-well multiplied by the water depth of 1,800' and further multiplying by the 60 wells yields a total well T&A cost of \$45 MM.

Table 8-4. Dry Tree Well T&A in WD >= 400', 60 Wells per platform

Typ. Strings to pull during T&A 7" @ 29#/ft or 9-5/8" @ 53.50 #/ft (Assumes 13"+26"+30" grouted and pulled during PLTF Prep)													
Water Depth Ft.	Dia in.	#/'	ft.	tons	Mob /Demob hrs each	Setup & Rig down hrs each	Typ. T&A per well hrs w/50% cut and pull	Added T&A hours per water depth per well	Pull /Cut per well hrs	Total cost per well w/o Setup & Mob /Demob	Total cost per platform wells	Total cost for 60 platform wells w/Work Provision, Engineering and Weather	Total cost per platform normalized to 1 well
400	9-5/8	53.5	928	24.8	30	12	48	14	35	\$331,547	\$20,132,304	\$28,789,195	\$479,820
500	9-5/8	53.5	1028	27.5	31	12	48	15	39	\$345,802	\$20,993,306	\$30,020,428	\$500,340
600	9-5/8	53.5	1128	30.2	32	12	48	16	43	\$360,057	\$21,854,308	\$31,251,660	\$520,861
700	9-5/8	53.5	1228	32.8	33	12	48	17	47	\$374,312	\$22,715,310	\$32,482,893	\$541,382
800	9-5/8	53.5	1328	35.5	34	12	48	18	50	\$385,716	\$23,405,252	\$33,469,510	\$557,825
900	9-5/8	53.5	1428	38.2	35	12	48	19	54	\$399,971	\$24,266,254	\$34,700,743	\$578,346
1000	9-5/8	53.5	1528	40.9	36	12	48	20	58	\$414,226	\$25,127,256	\$35,931,976	\$598,866
1100	9-5/8	53.5	1628	43.5	37	12	48	21	62	\$428,481	\$25,988,258	\$37,163,209	\$619,387
1200	9-5/8	53.5	1728	46.2	38	12	48	22	65	\$439,885	\$26,678,200	\$38,149,826	\$635,830
1300	9-5/8	53.5	1828	48.9	39	12	48	23	69	\$454,140	\$27,539,202	\$39,381,059	\$656,351
1400	9-5/8	53.5	1928	51.6	40	12	48	24	73	\$468,395	\$28,400,204	\$40,612,292	\$676,872
1500	9-5/8	53.5	2028	54.2	41	12	48	25	77	\$482,650	\$29,261,206	\$41,843,525	\$697,392
1600	9-5/8	53.5	2128	56.9	42	12	48	26	80	\$494,054	\$29,951,148	\$42,830,142	\$713,836
1700	9-5/8	53.5	2228	59.6	43	12	48	27	84	\$508,309	\$30,812,150	\$44,061,375	\$734,356
1800	9-5/8	53.5	2328	62.3	44	12	48	28	88	\$522,564	\$31,673,152	\$45,292,607	\$754,877
1900	9-5/8	53.5	2428	64.9	44	12	48	29	92	\$536,819	\$32,528,452	\$46,515,686	\$775,261
2000	9-5/8	53.5	2528	67.6	44	12	48	30	95	\$548,223	\$33,212,692	\$47,494,150	\$791,569
2100	9-5/8	53.5	2628	70.3	44	12	48	31	99	\$562,478	\$34,067,992	\$48,717,229	\$811,954
2200	9-5/8	53.5	2728	73.0	44	12	48	32	103	\$576,733	\$34,923,292	\$49,940,308	\$832,338
2300	9-5/8	53.5	2828	75.6	44	12	48	33	107	\$590,988	\$35,778,592	\$51,163,387	\$852,723
2400	9-5/8	53.5	2928	78.3	44	12	48	34	110	\$602,392	\$36,462,832	\$52,141,850	\$869,031
2500	9-5/8	53.5	3028	81.0	44	12	48	35	114	\$616,647	\$37,318,132	\$53,364,929	\$889,415
2600	9-5/8	53.5	3128	83.7	44	12	48	36	118	\$630,902	\$38,173,432	\$54,588,008	\$909,800
2700	9-5/8	53.5	3228	86.3	44	12	48	37	122	\$645,157	\$39,028,732	\$55,811,087	\$930,185
2800	9-5/8	53.5	3328	89.0	44	12	48	38	125	\$656,561	\$39,712,972	\$56,789,550	\$946,492
2900	9-5/8	53.5	3428	91.7	44	12	48	39	129	\$670,816	\$40,568,272	\$58,012,629	\$966,877
3000	9-5/8	53.5	3528	94.4	44	12	48	40	133	\$685,071	\$41,423,572	\$59,235,708	\$987,262
3100	9-5/8	53.5	3628	97.0	44	12	48	41	137	\$699,326	\$42,278,872	\$60,458,787	\$1,007,646
3200	9-5/8	53.5	3728	99.7	44	12	48	42	140	\$710,730	\$42,963,112	\$61,437,250	\$1,023,954
3300	9-5/8	53.5	3828	102.4	44	12	48	43	144	\$724,985	\$43,818,412	\$62,660,329	\$1,044,339
3400	9-5/8	53.5	3928	105.1	44	12	48	44	148	\$739,240	\$44,673,712	\$63,883,408	\$1,064,723
3500	9-5/8	53.5	4028	107.7	44	12	48	45	152	\$753,495	\$45,529,012	\$65,106,487	\$1,085,108
3600	9-5/8	53.5	4128	110.4	44	12	48	46	155	\$764,899	\$46,213,252	\$66,084,950	\$1,101,416
3700	9-5/8	53.5	4228	113.1	44	12	48	47	159	\$779,154	\$47,068,552	\$67,308,029	\$1,121,800
3800	9-5/8	53.5	4328	115.8	44	12	48	48	163	\$793,409	\$47,923,852	\$68,531,108	\$1,142,185
3900	9-5/8	53.5	4428	118.4	44	12	48	49	167	\$807,664	\$48,779,152	\$69,754,187	\$1,162,570
4000	9-5/8	53.5	4528	121.1	44	12	48	50	170	\$819,068	\$49,463,392	\$70,732,651	\$1,178,878
4100	9-5/8	53.5	4628	123.8	44	12	48	51	174	\$833,323	\$50,318,692	\$71,955,730	\$1,199,262
4200	9-5/8	53.5	4728	126.5	44	12	48	52	178	\$847,578	\$51,173,992	\$73,178,809	\$1,219,647
4300	9-5/8	53.5	4828	129.1	44	12	48	53	182	\$861,833	\$52,029,292	\$74,401,888	\$1,240,031
4400	9-5/8	53.5	4928	131.8	44	12	48	54	185	\$873,237	\$52,713,532	\$75,380,351	\$1,256,339
4500	9-5/8	53.5	5028	134.5	44	12	48	55	189	\$887,492	\$53,568,832	\$76,603,430	\$1,276,724
4600	9-5/8	53.5	5128	137.2	44	12	48	56	193	\$901,747	\$54,424,132	\$77,826,509	\$1,297,108
4700	9-5/8	53.5	5228	139.8	44	12	48	57	197	\$916,002	\$55,279,432	\$79,049,588	\$1,317,493
4800	9-5/8	53.5	5328	142.5	44	12	48	58	200	\$927,406	\$55,963,672	\$80,028,051	\$1,333,801
4900	9-5/8	53.5	5428	145.2	44	12	48	59	204	\$941,661	\$56,818,972	\$81,251,130	\$1,354,185
5000	9-5/8	53.5	5528	147.9	44	12	48	60	208	\$955,916	\$57,674,272	\$82,474,209	\$1,374,570
Using typical platform crane at 25 st and typical largest string to pull during T&A (9-5/8"), at 400' WD the crane capacity is exceeded and therefore casing jacks are necessary for all platform P&A >400' WD (A leap frog crane could also be installed when some of the strings are removed - saving time)													

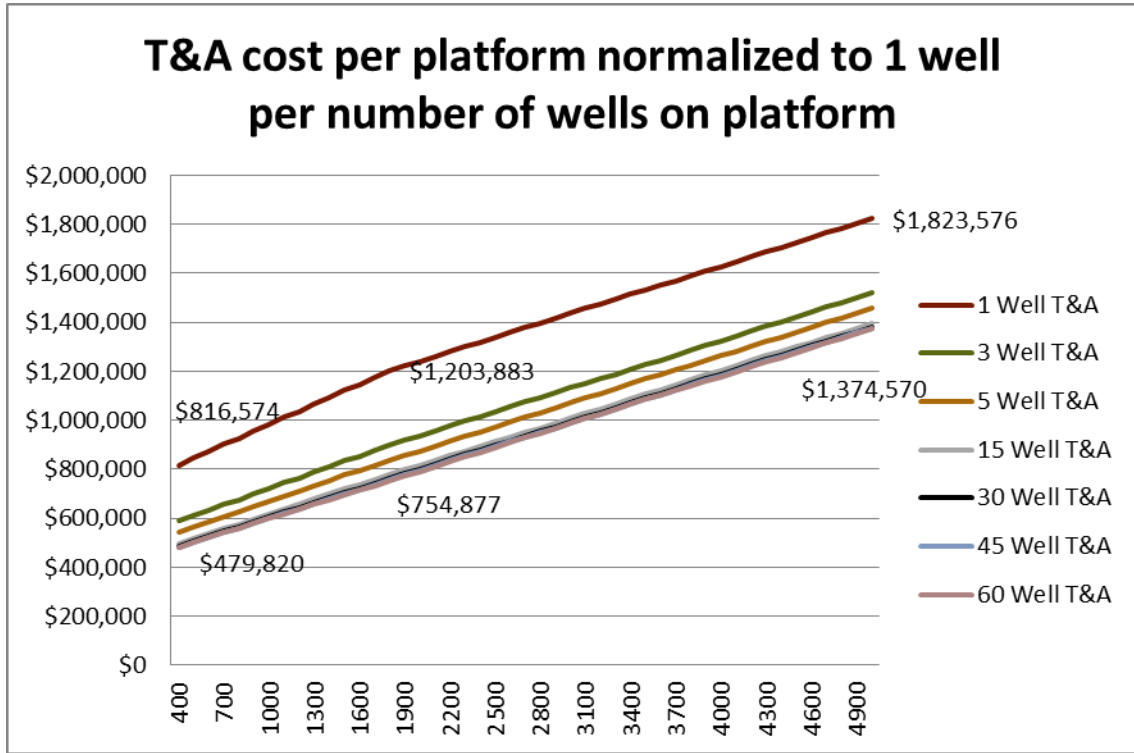

Figure 8-7. T&A Cost per Well as a Function of WD and Number of Wells

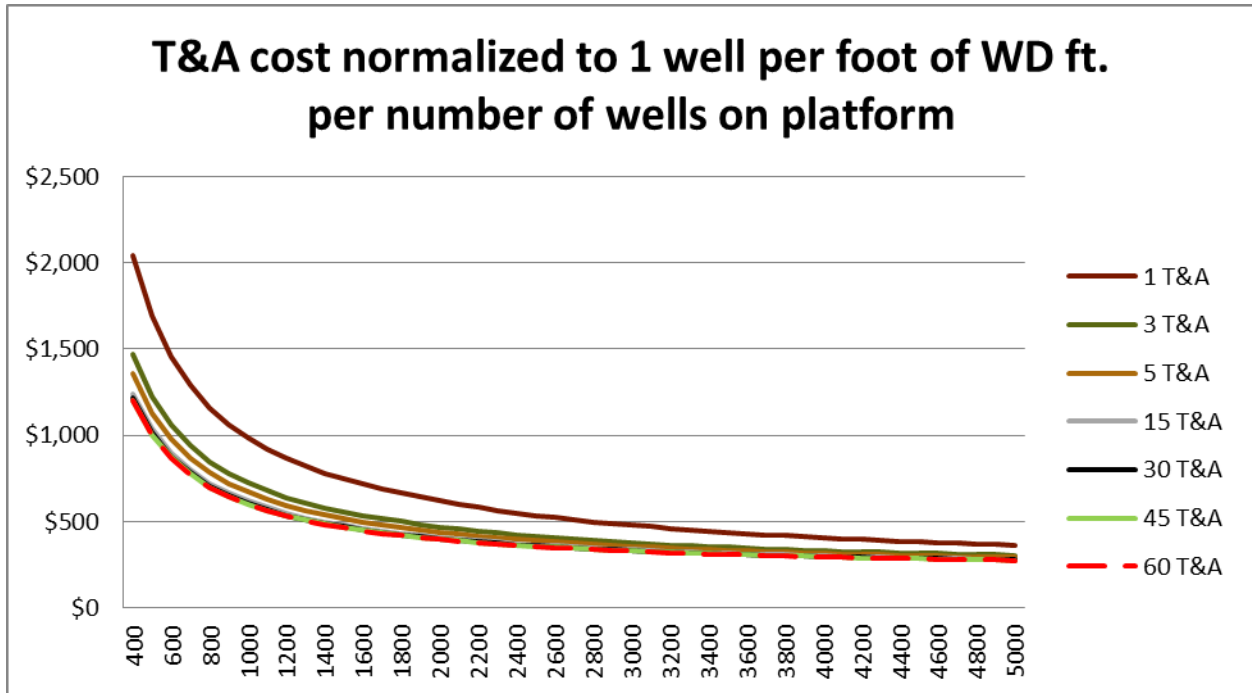

Figure 8-8. T&A Cost per Foot of Well as a Function of WD and Number of Wells

### 8.3.2.3. Wet Tree Wells

Wet tree well plugging and abandonment is performed to achieve the same results on subsea wells as a standard well plug and abandonment. The same barriers are required to be placed and tested. The key difference is that a standalone vessel MSV (Non-MODU) or rig (MODU, semi-submersible or drillship) is required to connect to the well and gain access to the wellbore. This greatly increases the cost. The single largest contributing factor to cost is the rig or vessel.

There is additional risk of environmental impact. As stated, the wellbore must be accessed to allow barriers to be put into place. The additional steps, connections and devices to maintain pressure control (well control in a worst case scenario) introduce additional risk. This is similar to the risk exposure in a drilling situation except that the well pressures and fluids are known during P&A. This allows for fluid preparation to maintain well control.

The additional interfaces and services required increase the complexity. The well design also makes the well abandonment more complicated than dry tree well P&A. There are normally additional annuli due to more casings and liners run for a subsea well completion in the Gulf of Mexico. This requires additional steps to seal off the barriers or to cut and remove the casing to gain access to the annuli. A subsea well abandonment requires additional planning to ensure that isolation of the zones and annuli are achieved on a first attempt. Any additional operations would significantly increase the cost of the abandonment.

Some companies require the use of a MODU for subsea well abandonment. The additional capabilities of a full rig can reduce additional time requirements if any issues occur during the well abandonment. If the company has a long term contract with a rig this can be cost effective.

With the newly developed technology and equipment, an MSV (non-MODU) can perform the required abandonment if approval to abandon the wellhead in place is granted by BSEE regulations to provide a waiver if water depth exceeds 800 meters, doesn't cause an obstruction, or poses safety concerns. Methodology to perform well P&A without riser and rig is gaining acceptance in the oil and gas industry, for example: Wild Well Control's *DeepRange* used in Gulf of Mexico and West Africa, and The Cross Group's CROSS package used in Gulf of Mexico. This methodology reduces daily spread rate and allows a cheaper alternative to using a full rig. There are situations where achieving the full abandonment may not be possible. This risk needs to be quantified during the method selection stage of the well abandonment to ensure the best method is selected for the job.

Another basic alternative is to use an MSV-T (MSV with Tower). The MSV-T has a tower for higher lifting capability allowing tripping pipe and running a riser. The same operation as a rig is performed, but the daily spread rate is less.

Some companies prefer combining the use of a non-MODU and MODU to limit the total time required for an MODU to be on location. A non-MODU (MSV or alternative) can perform the lower abandonment (isolating the reservoir from the wellbore and placing annuli barriers in place), and a MODU can arrive at

a later planned date to perform the upper abandonment (surface plug, cut and recover casing if required, and cutting and recovering wellhead if required).

Each subsea well needs to be reviewed for a proper abandonment estimate. Some subsea well structures will require additional time for access to place barriers into additional locations (multiple zone well, extra casings, etc.). Generally the abandonment duration is based on water depth, perforations (reservoir access – screens), and packer depth. The key impact is water depth.

Figure 8-9 shows the relationship between water depth and subsea well P&A duration. Figure 8-10 shows the relationship of WD to cost. These are simplified examples based on drillship (MODU) at \$450,000 per day, MSV (Non-MODU) at \$260,000 per day, services required for well abandonment, and time for abandonment. Mobilization costs are not included. The mobilization costs can significantly impact selection of method. A total cost review based on abandonment, mobilization, demobilization, and travel between wells should be considered for a cost effective selection.

The approximate costs of a total spread are \$674,600/day for a MODU spread and \$466,000/day for a non-MODU spread. These are rough estimates based on current day rate and service rates from several vendors. Discounts could be negotiated based on the scope and amount of work to be done. Due to low oil prices, some service providers are starting to lower resource rates. Also, some company requirements for operations require additional equipment that may not be included. The formula below can be used for a rough estimate.

$$MODU = [(Mob + Demob) * (1 + Eng/PM) + (Operations\ time) * (1 + Weather + Work + Eng/PM)] * (MODU\ rate)$$

$$NonMODU = [(Mob + Demob) * (1 + Eng/PM) + (Operations\ time) * (1 + Weather + Work + Eng/PM)] * (NonMODU\ rate)$$

*NonMODU Lower & MODU Upper*

$$\begin{aligned} &= (Mob + Demob) * (NonMODU\ rate) * (1 + Eng/PM) \\ &+ (Operations\ time\ of\ NonMODU) * (NonMODU\ rate) * (1 + Weather + Work + Eng/PM) \\ &+ (Mob + Demob) * (MODU\ rate) * (Eng/PM) \\ &+ (Operations\ time\ of\ MODU) * (MODU\ rate) * (1 + Weather + Work + Eng/PM) \end{aligned}$$

The split duration between Non-MODU lower and MODU upper is based on depth. MODU duration percentage ranges from 35% of the total duration at 1000 ft water depth to 39% at 9000 ft water depth. One can interpolate the range to estimate the MODU duration portion. The Eng/PM percentage remains at 8% and the weather contingency allowance remains at 20%. However, the work provision percentage is reduced to 10% for wet tree wells. These percentages are included in the cost curves in Figure 8-9 and Figure 8-10.

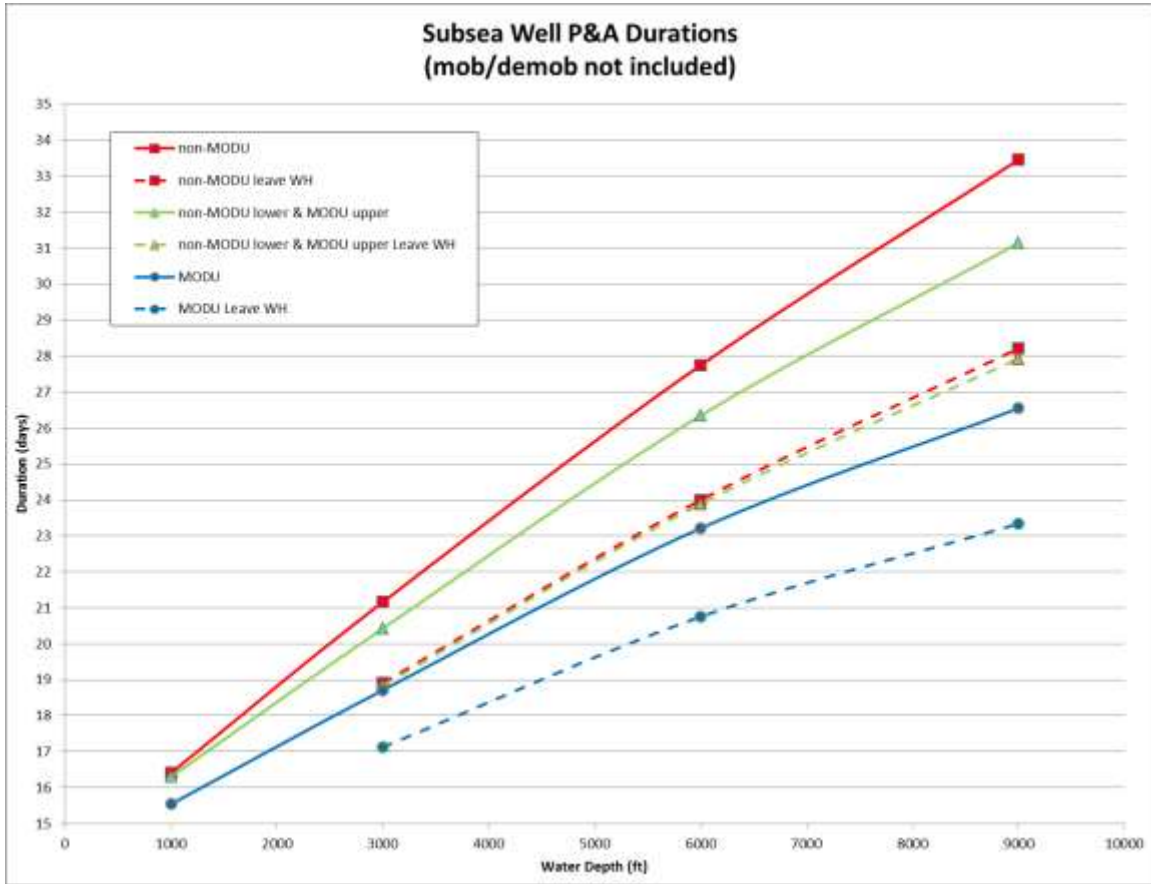

Figure 8-9. Subsea Well P&A Durations (mob/demob not included)

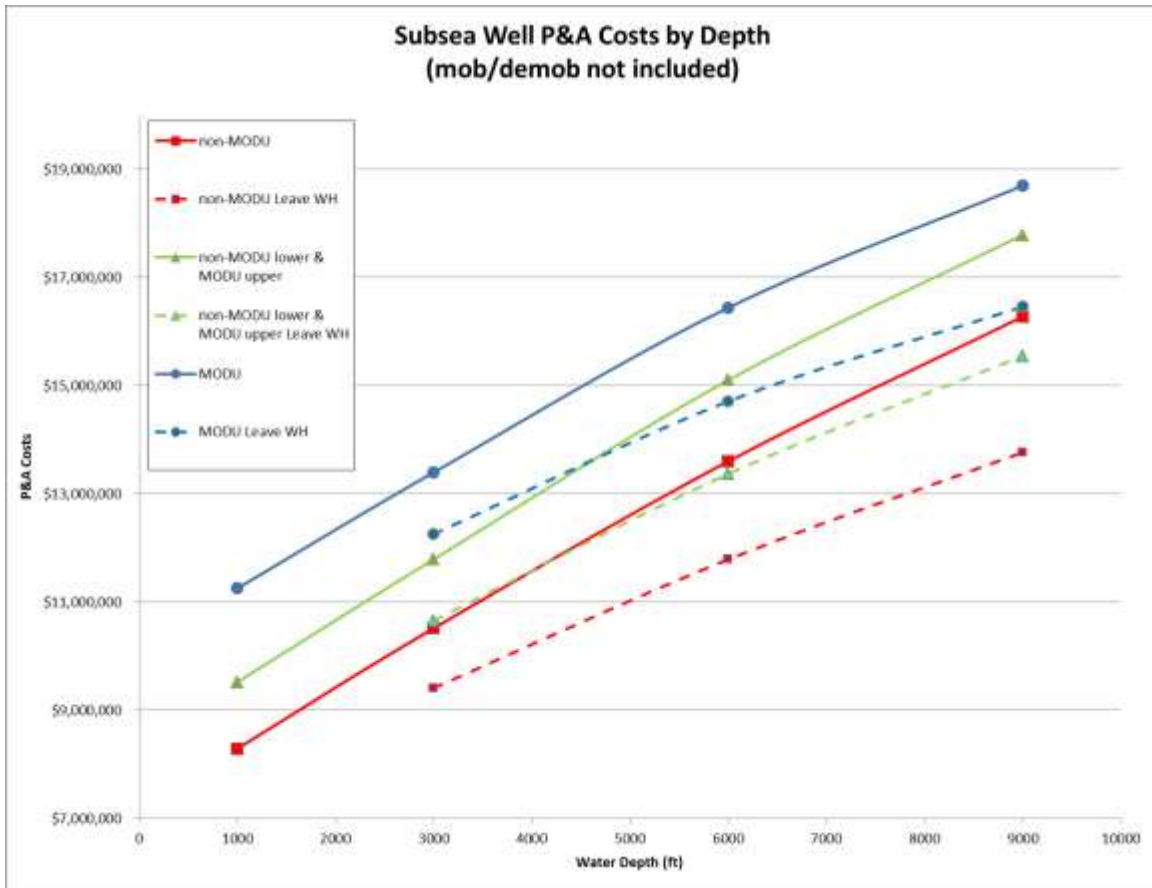

Figure 8-10. Subsea Well P&A Costs by Depth (mob/demob not included)

### 8.3.3. Pipeline Decommissioning

Pipelines are considered abandoned when the pipeline has been pigged or flushed and the ends have been severed, plugged and buried. The pipeline ends are buried either by jetting below the mudline or by covering the ends with sand bags or articulated concrete mats. The pipeline is then left in place (see Chapter 5.2.6.).

Though there are exceptions, the following are typical types of vessels used in pipeline abandonment for the GOM platform water depths. Each type of vessel as listed is consecutively more expensive to operate.

- Workboats (WB) are used in water depths less than 120' for riser to riser operations only. Workboats are almost always used with every pigging or filtration operation. Workboats typically have living quarters for 12-14 people and can range in size from 100'-180'.
- Anchored 4-point dive boats (4PDB) are used in water depths less than 400' to 500', using a rule-of-thumb 7:1 anchor cable length to water depth ratio, i.e. scope. The limiting factor is the length of anchor cable typically onboard. Using a lower anchor cable ratio, a water depth of 600'+ would be a typical upper limit.

- Dynamically positioned dive boats (DPDB) can operate in all water depths, but are typically used where subsea tie-ins are involved or where water depths are from 600' to approximately 800', that being the upper range of saturation diving. DPDB's are also used in shallower water depths where there is a lot of bottom debris or where there are multiple pipelines located in the area that could interfere with anchoring.
- Dynamically positioned Deep Sea Intervention vessels (DSI) with remotely operated vehicle (ROV) capability can operate in all water depths, but are typically used in water depths over 800'.

Regardless of the vessel used, most of the tasks in pipeline abandonment are the same for a given type of abandonment; i.e., pipelines that start and end at a platform riser require similar tasks and pipelines that have a platform riser at one end and a SSTI at the other have similar abandonment tasks. The major variables that change are the flushing duration and the pipeline spread used.

### 8.3.3.1. Flushing

Standard industry practice is to flush a pipeline at a rate of 1 to 3 feet per second (FPS). Pump flow rates need to be calculated to achieve the linear fluid velocity based on cross sectional area and volume. The pipeline volume per foot is calculated by the following formula:

$$v = \frac{\pi}{4} ID^2 * \frac{1 \text{ ft}^2}{144 \text{ in}^2} * \frac{7.48 \text{ gal}}{\text{ft}^3} = 0.0408 \frac{\text{gpf}}{\text{in}^2} * ID^2$$

where  $v$  = pipeline unit volume in gallons per foot (gpf)  
 $ID$  = pipeline internal diameter in inches

This pipeline unit volume is then multiplied by the total length,  $L$ , of the pipeline to provide the total volume,  $V$ , of the pipeline in gallons. An example for the total volume of a 15,840 ft long, 6.065 inch ID pipeline is shown below.

$$v = 0.0408 \frac{\text{gpf}}{\text{in}^2} * (6.065 \text{ in})^2 = 1.50 \text{ gpf}$$

$$V = v * L = 1.50 \text{ gpf} * 15,840 \text{ ft} = 23,760 \text{ gal}$$

Pipeline decommissioning costs were estimated from the representative platforms in Table 8-4. Flushing volumes, water depth, mobilization distance and vessel spread requirements were evaluated. It was determined that the two variables, flushing volume and vessel spread can be used to determine a reasonable decommission cost. The pipeline cost estimates listed in Table 8-5 include 8% for engineering and project management, 20% contingency for weather, and 15% for project work contingency.

### 8.3.3.2. Pipeline Spreads

The lists below present typical pipeline spreads used to decommission different pipeline configurations. All of the spreads also include a workboat and decommissioning crew at the receiving platform. If the



receiving platform cannot process the flushed fluids and if the fluids cannot be injected downhole or pumped into the receiving pipeline, then a filter spread is added to the spreads below.

#### Riser to Riser

- Workboat, Flushing Crew & Equipment, Surface Air Divers for WD <120' (Note 1)
- 4-Point DSV (4PDB), Flushing Crew & Equipment, Mixed Gas Divers for WD 121'-299' (Note 1)
- DP DSV, Flushing Crew & Equipment, Saturation Divers for WD 300'-800' (Note 1)
- DP DSV, Flushing Crew & Equipment, Dual ROV system for WD >800' (Note 1)

#### Riser to SSTI

- 4PDB, Flushing Crew & Equipment, Surface Air Divers for WD <120' (Note 1)
- 4-Point DSV (4PDB), Flushing Crew & Equipment, Mixed Gas Divers for WD 121'-299' (Note 1)
- DP DSV, Flushing Crew & Equipment, Saturation Divers for WD 300'-800' (Notes 1 & 2)
- DP DSV, Flushing Crew & Equipment, Dual ROV system for WD >800' (Notes 1 & 2)

#### SSTI to SSTI

- 2 Spreads - 4PDB, Flushing Crew & Equipment, Surface Air Divers for WD <120'
- 2 Spreads - 4PDB, Flushing Crew & Equipment, Mixed Gas Divers for WD 121'-299'
- 2 Spreads - DP DSV, Flushing Crew & Equipment, Saturation Divers for WD 300'-800' (Note 2)
- 2 Spreads - DP DSV, Flushing Crew & Equipment, Dual ROV system for WD >800' (Note 2)

**Note 1** – Requires a workboat and decommissioning crew at the receiving platform.

**Note 2** – Coil tubing is required for WD >600'.

**Table 8-5. Pipeline Decommissioning Cost**

WD (ft.)	Pipe-line #	Spread Usage	Mob Distance (NM)	Pipeline OD (in.)	Pipeline ID (in.)	Length (ft.)	250% Flush Volume (gal)	Decom. Cost <sup>12</sup>
118	1	Workboat	60	6.625	6.065	7,042	26,423	\$260,968
156	2	4PDB	103	8.625	7.981	19,990	129,875	\$468,284
400	3	4PDB	137	4.500	4.026	6,160	10,185	\$945,026
446	4	4PDB	122	6.625	6.065	101,713	381,628	\$1,333,049
446	5	4PDB	122	8.625	7.981	194,110	1,261,138	\$1,716,112
446	6	4PDB	122	16.000	15.000	67,266	1,542,838	\$1,506,339
50	7	4PDB-SSTI	165	6.625	6.065	7,922	29,723	\$293,907
216	8	4PDB-SSTI	189	6.625	6.065	8,742	32,800	\$486,303
216	9	4PDB-SSTI	189	8.625	7.981	12,450	80,888	\$496,636
400	10	4PDB-SSTI	137	6.625	6.065	4,884	18,325	\$748,541
410	11	4PDB-SSTI	200	10.750	10.020	74,250	760,383	\$1,195,228
483	12	4PDB-SSTI	100	12.750	11.938	120,000	1,744,395	\$1,524,293

<sup>12</sup> The pipeline decommissioning costs include the following; mobilization, rigging up, flushing, cutting, plugging/capping, rigging down, demobilization, work provision, weather contingency and engineering/project management costs.

WD (ft.)	Pipe-line #	Spread Usage	Mob Distance (NM)	Pipeline OD (in.)	Pipeline ID (in.)	Length (ft.)	250% Flush Volume (gal)	Decom. Cost <sup>12</sup>
693	13	DPDB	96	12.750	11.938	14,217	206,668	\$1,867,472
693	14	DPDB	96	14.000	13.250	13,611	243,738	\$1,892,577
622	15	DPDB-SAT-SSTI	75	6.625	6.065	42,375	158,990	\$1,592,976
622	16	DPDB-SAT-SSTI	75	10.750	10.020	22,707	232,540	\$1,536,291
774	17	DPDB-ROV-SSTI	110	8.625	7.981	66,706	433,390	\$846,644
863	18	DPDB-ROV-SSTI	193	12.750	11.938	49,106	713,835	\$984,590
1000	19	DSI-SSTI	119	8.625	7.981	36,959	240,123	\$1,123,847
1000	20	DSI-SSTI	119	8.625	7.981	17,713	115,083	\$1,033,760
1027	21	DSI-SSTI	157	12.750	11.938	39,673	576,710	\$1,430,473

### 8.3.4. Umbilical Decommissioning

For the purpose of this study, it is assumed that all hydraulic umbilicals are flushed of chemicals and both hydraulic and electrical umbilicals are removed. As in pipeline abandonment, depending on water depth and umbilical length, different removal spreads can be used. Because the majority of umbilicals in the GOM will be in deeper water at various lengths, this section focuses on the use of an anchor handling support vessel (AHSV) and ROV spread.

For each umbilical, first set up on the umbilical. If the umbilical is hydraulic, flush the umbilical to the host, cut the umbilical, attach to cable spool on AHSV, spool the umbilical, and cut umbilical at the host. If spool can hold more than one umbilical (dependent on diameter, length, and spool capacity) then set up on next umbilical; if not, relocate to shore to unspool the umbilical(s). The estimated cost per umbilical per foot water depth is estimated in Table 8-6 and Figure 8-11.

**Table 8-6. Umbilical Removal Costs**

Estimated Umbilical Removal Cost per Foot of WD						
Umbilical Nautical Mile (NM)	1	2	3	5	10	20
400' WD	\$13.46	\$7.57	\$5.60	\$4.03	\$2.85	
1000' WD	\$17.60	\$9.63	\$6.98	\$4.86	\$3.27	
2000' WD		\$11.29	\$8.08	\$5.52	\$3.60	\$2.63
4000' WD			\$9.28	\$6.24	\$3.96	\$2.81
6000' WD				\$6.96	\$4.32	\$2.99
8000' WD				\$7.84	\$4.76	\$3.22
10000' WD				\$8.73	\$5.20	\$3.44
Average	\$15.53	\$9.50	\$7.49	\$6.31	\$3.99	\$3.02

Note: Costs do not include mobilization and demobilization costs

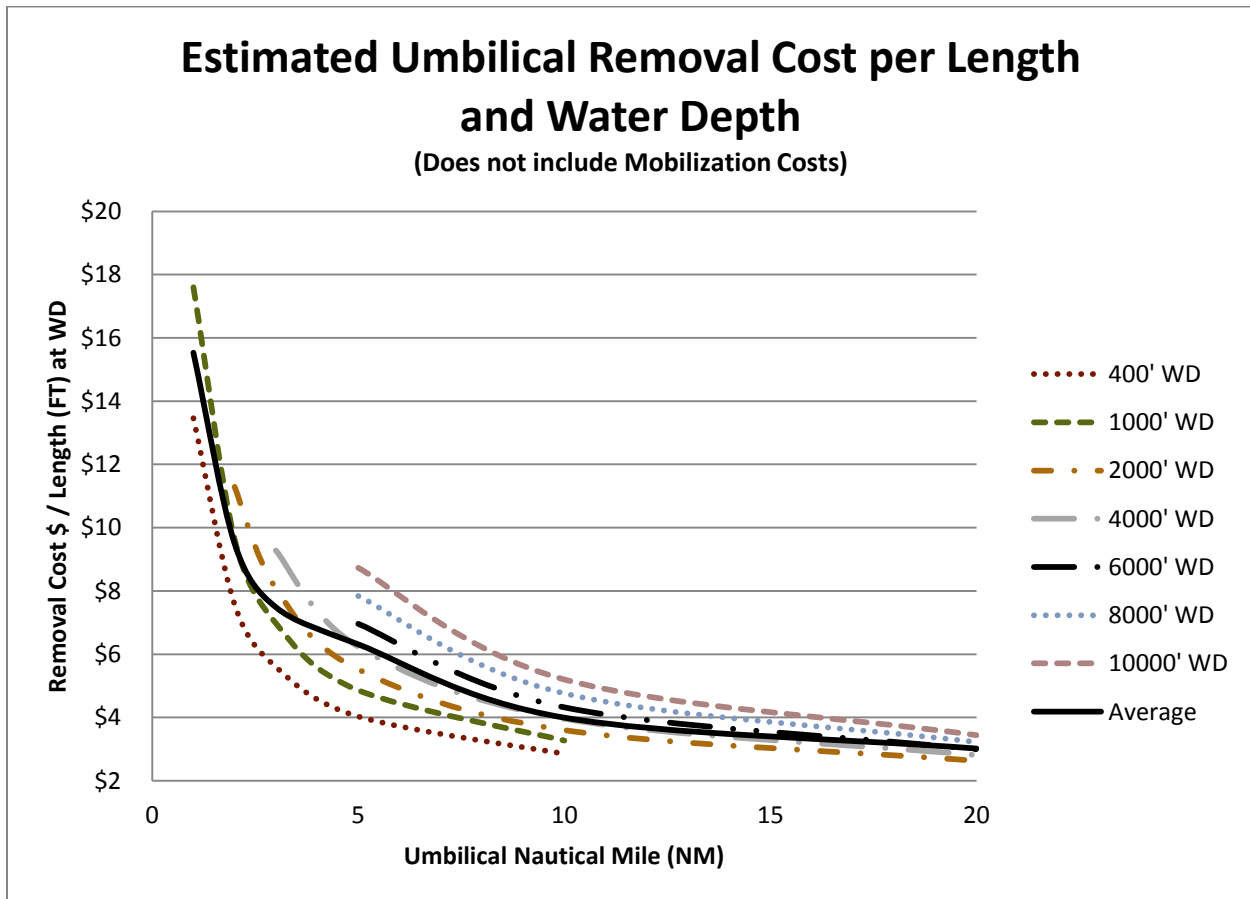

Figure 8-11. Umbilical Removal Costs

### 8.3.5. Conductor Removal

The deeper the water depth, the more costly the conductors are to remove because greater lifting capacity is required. Whether removed with a platform crane, rental crane, casing jacks, drilling rig or a HLV, each method has limitations on the maximum length that can be sectioned and removed. For deeper water more sections are required to be cut and removed.

Aside from the water depth, cost drivers in conductor removal are the number of conductors, the method of severing, and the method of removal. The costs for the mobilization, equipment set up and rig down, and demobilization must be allocated over the number of conductors so on a platform with few conductors these allocated costs are higher per conductor, whereas for a platform with many conductors these allocated costs are lower per conductor.

The two most common conductor severing options used in the GOM are explosive severing and abrasive severing. Several comparisons between explosive and abrasive operations conducted during the platform removal using a derrick barge are provided in Table 8-7.

**Table 8-7. Comparison of Explosive and Abrasive Severing Costs**

	Explosive	Abrasive	Difference
Example 1: Platform in 224' WD with four 42" diameter piles and four 30" conductors			
Hours to sever	15	38	253%
Total work exposure hours	1865	2081	12%
Total cost	\$3,408,108	\$4,018,630	18%
Example 2:			
Total work exposure hours	4251	4494	6%
Total cost	\$6,062,260	\$6,954,753	15%

The table above shows that though the actual duration to sever abrasively is more than double the duration to sever explosively, the total work exposure hours during the platform removal project using abrasive severing only increase between 6%-12% than using explosive severing and the overall platform removal costs using abrasives increase between 15% and 18% over explosives. The severing cost comparisons were performed during the derrick barge operations with the higher cost of the derrick barge spread and with the higher lifting capacity of the derrick barge to overcome the possibility of excessive flaring.

Abrasive severing would be the preferred method to eliminate flaring, but takes longer, thus driving up costs. Using explosives is generally faster and less expensive, but there is always the possibility that:

- the conductors will flare out from the detonation and get stuck when being pulled through the conductor guides if they are not cut and removed and
- the presence of protected marine life may delay the explosive operations, increasing costs as the HLV stands by.

To minimize these costs, the majority of representative platforms in Table 8-1 were estimated with the conductors severed abrasively and removed with casing jacks prior to the derrick barge arrival. Though removal with casing jacks generally takes longer than removal with a derrick barge, the reduction in work spread costs makes removal with casing jacks more economical. Especially for platforms in deeper water where typically a larger and more costly derrick barge or heavy lift vessel (HLV) is required. Figure 8-12 shows how conductor removal costs using abrasive severing and casing jacks vary for different numbers of conductors and different water depths. As shown, the unit cost increases as the water depth increases and the costs per conductor decrease as the number of conductors increase.

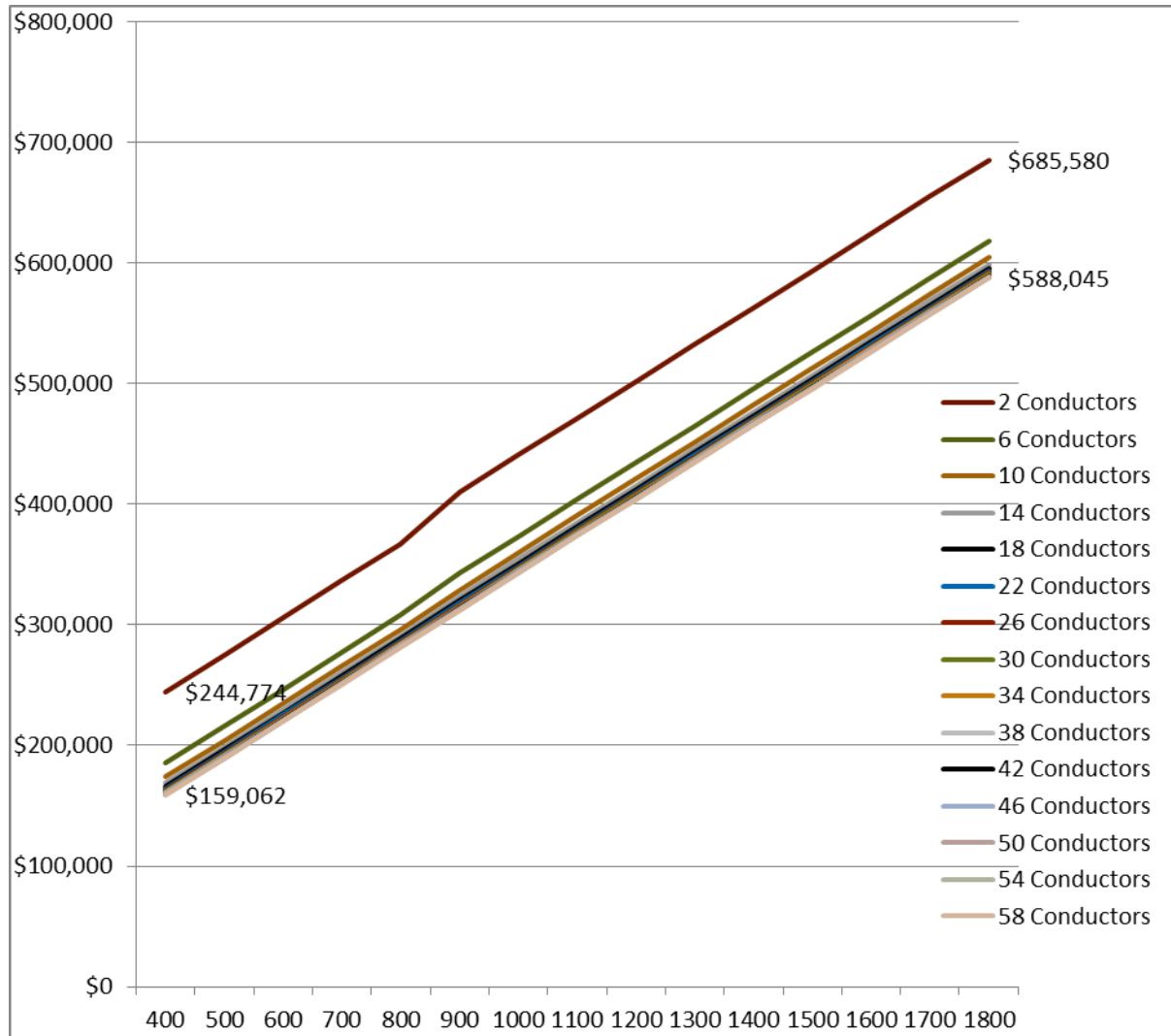

Figure 8-12. Total Cost per Conductor for Removal Using Abrasive Severing and Casing Jacks

## 8.3.6. Platform Decommissioning

### 8.3.6.1. Fixed Platforms

Current fixed platforms in the GOM are installed in water depths up to about 1,300', not including compliant towers. Table 8-8 shows representative fixed platforms that were selected to obtain a range of estimated costs that may be used to compare the reasonableness of cost estimates for other similar platforms at similar water depths. For confidentiality, the table does not show the identifying locations of the platforms. The Pile column describes the type of platform leg, leg pile and or skirt pile configuration. The most economical heavy lift vessel, Derrick Barge or Semi-Submersible Crane Vessel – SSCV (see DB column) was selected on the basis of the lifting capacity required for the platform's removal using the method listed in the Method column. The deck and jacket weights were either known

or else reasonable assumptions were made based on similar platforms in similar water depths from TSB's database. The appropriate derrick barge was selected based on the lift weights.

Only the most economical removal method estimated is included for each representative platform. The three methods of determining decommissioning cost that were found to be most economical were 1) complete removal in a single lift 2) removal by towing to shallower water (hopping) or 3) jacket sectioning for larger jackets located in water depths  $\geq 700'$ . In Table 8-8, piles or skirt piles  $\leq 60"$  diameters were severed with explosives and piles  $>60"$  in diameter were severed abrasively. The costs do include the cargo barge usage during offloading, but do not include dock charges or crane charges.

Table 8-8 shows there is considerable fluctuation in the leg, pile, and skirt pile configurations in the 500', 800', and  $>1000'$  ranges, but the numbers generally increase in proportion to the deeper ranges. The increase in the water depth and in the number of structural members increases the decommissioning cost as shown in Figure 8-13, where trend line is for cost without conductors and artificial trendline is for cost with conductors. The estimated costs shown include platform preparation, deck removal, jacket removal, and site clearance. Because conductor severing and removal can be a major cost and is dependent on the number of conductors, water depth and the removal method selected, costs are shown both with and without conductor removal in Table 8-8 and Figure 8-13.

**Table 8-8. Estimated Decommissioning Costs of Representative Fixed Platforms**

No.	Water Depth (ft.)	Piles <sup>a</sup>	Derrick Barge	Method	# of Conductors	Cost w/ Conductors	Cost w/o Conductors
1	50	3P	DB300	Complete Removal	1	\$1,410,391	\$1,356,609
2	118	4P	DB600	Complete Removal	1	\$2,425,276	\$2,350,138
3	156	4P	DB800	Complete Removal	6	\$3,306,325	\$2,864,002
4	216	4P	DB2K	Complete Removal	2	\$2,873,582	\$2,667,675
5	269	4P	DB2K	Complete Removal	16	\$6,315,020	\$4,037,901
6	308	4P	DB2K	Complete Removal	5	\$3,766,927	\$3,211,260
7	400	4L-1P-4SP	DB4K	Complete Removal	6	\$7,245,372	\$6,325,185
8	410	8P-12SP	DB4K	Complete Removal	5	\$8,215,033	\$7,358,113
9	446	4P-4SP	DB4K	Complete Removal	5	\$11,777,547	\$10,986,382
10	480	8P-12SP	SSCV	Complete Removal	18	\$15,718,760	\$13,237,646
11	483	8P-12SP	DB4K	Tow to Shallow	19	\$32,029,880	\$29,483,696
12	484	4P	DB2K	Tow to Shallow	2	\$6,836,169	\$6,421,978
13	523	4P-4SP	DB2K	Tow to Shallow	7	\$9,375,800	\$8,148,032
14	619	4P-4SP	DB4K	Tow to Shallow	8	\$15,790,690	\$14,276,249
15	622	4L-8SP	DB4K	Tow to Shallow	16	\$20,508,850	\$18,299,870
16	693	4L-8SP	DB4K	Jacket Sectioning	3	\$15,093,830	\$14,370,446
17	774	8P-12SP	SSCV	Jacket Sectioning	24	\$41,194,940	\$35,266,998
18	863	8P-12SP	SSCV	Jacket Sectioning	26	\$48,423,520	\$42,462,164
19	925	4P-8SP	DB4K	Jacket Sectioning	14	\$23,592,310	\$20,030,019
20	935	8P-16SP	SSCV	Jacket Sectioning	21	\$40,385,740	\$34,981,872
21	1027	12L-24SP	SSCV	Jacket Sectioning	62	\$76,198,304	\$59,277,966

No.	Water Depth (ft.)	Piles <sup>a</sup>	Derrick Barge	Method	# of Conductors	Cost w/ Conductors	Cost w/o Conductors
22	1100	6P-24SP	SSCV	Jacket Sectioning	34	\$62,238,048	\$53,217,928
23	1300	12L-32SP	SSCV	Jacket Sectioning	29	\$102,992,200	\$95,640,620

<sup>a</sup> Pile Notation: 4L-1P-4SP = 4 leg platform with 1 Center Pile and 4 Skirt Piles  
4P-4SP = 4 leg platform with 4 leg piles and 4 Skirt Piles

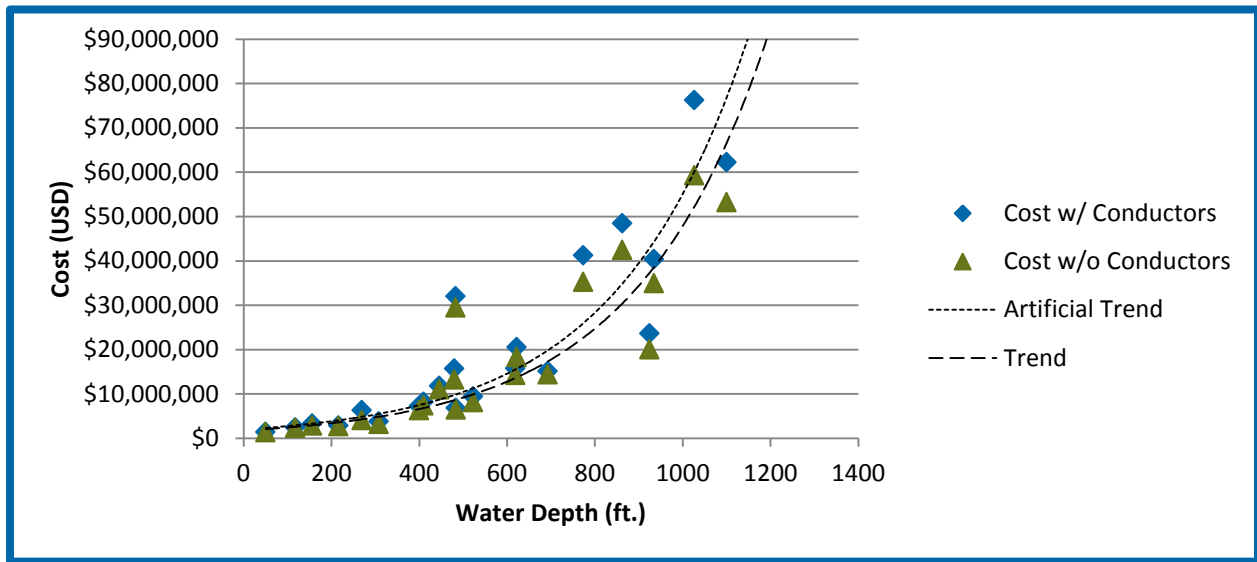

**Figure 8-13. Estimated Platform Decommissioning Costs**

Figure 8-14 presents platform cost curves from the data in Table 8-8 for the platforms removed in a single lift, corresponding to water depths of 50 to 480 feet. Figure 8-15 presents similar curves for platforms in 483 to 622 feet of water removed by towing to shallower water. Figure 8-16 presents the estimated cost data for platforms in 693 to 1300 feet of water removed by jacket sectioning.

Platform characteristics and cost data on compliant towers in deeper waters was not available to develop cost trends for decommissioning these platforms. As an alternative, the trendline for deep water removals in Figure 8-17 could be used for an initial estimate for platforms requiring an HLV.

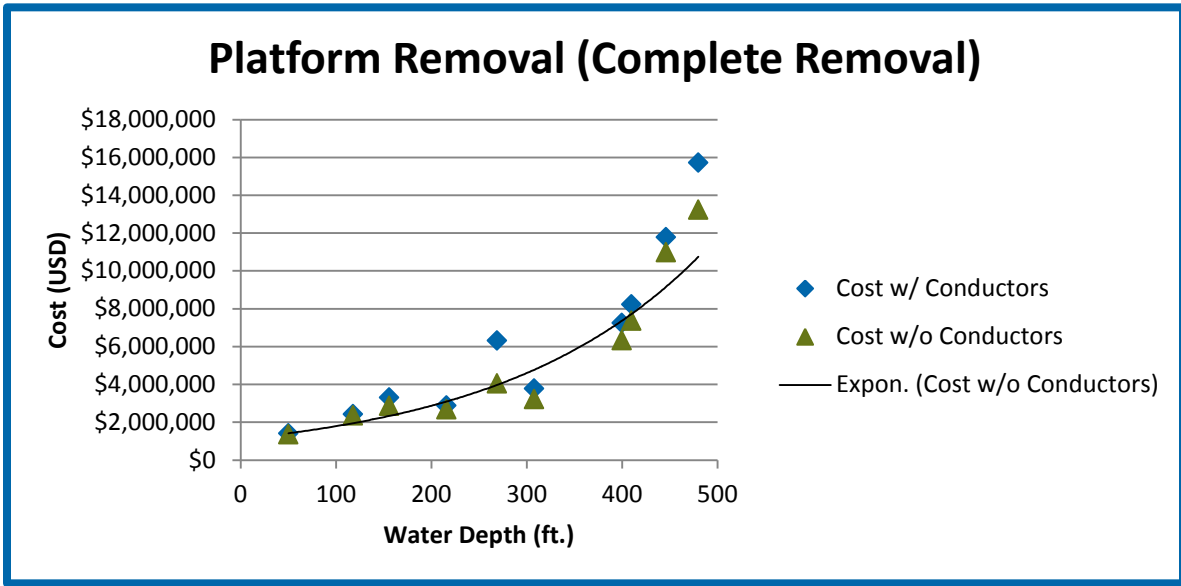

Figure 8-14. Platform Removal Costs, Single Lift

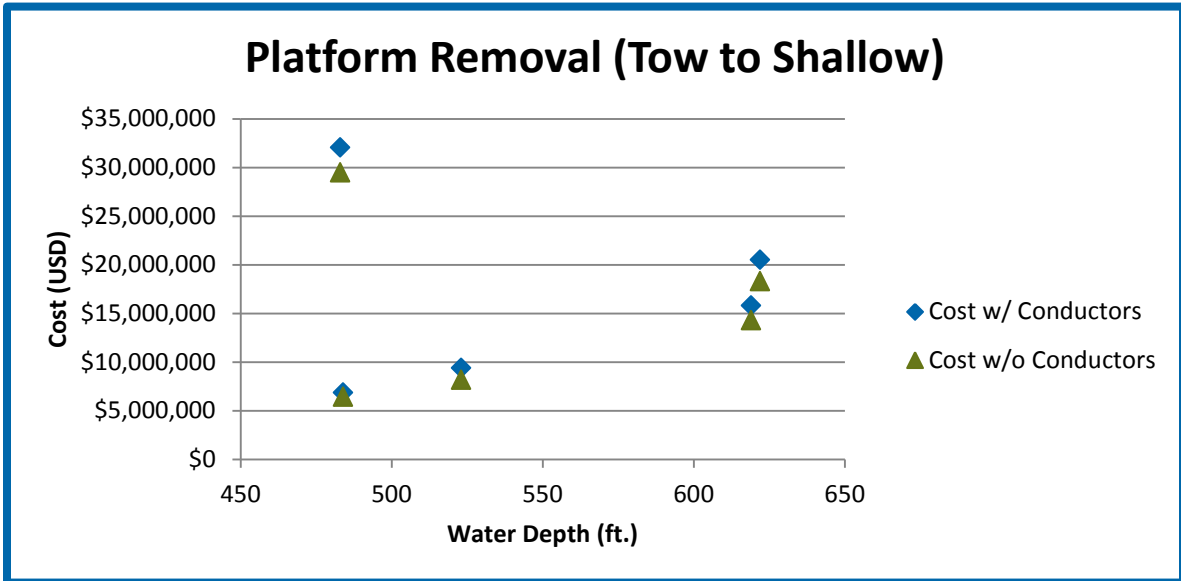

Figure 8-15. Platform Removal Costs, Tow to Shallow



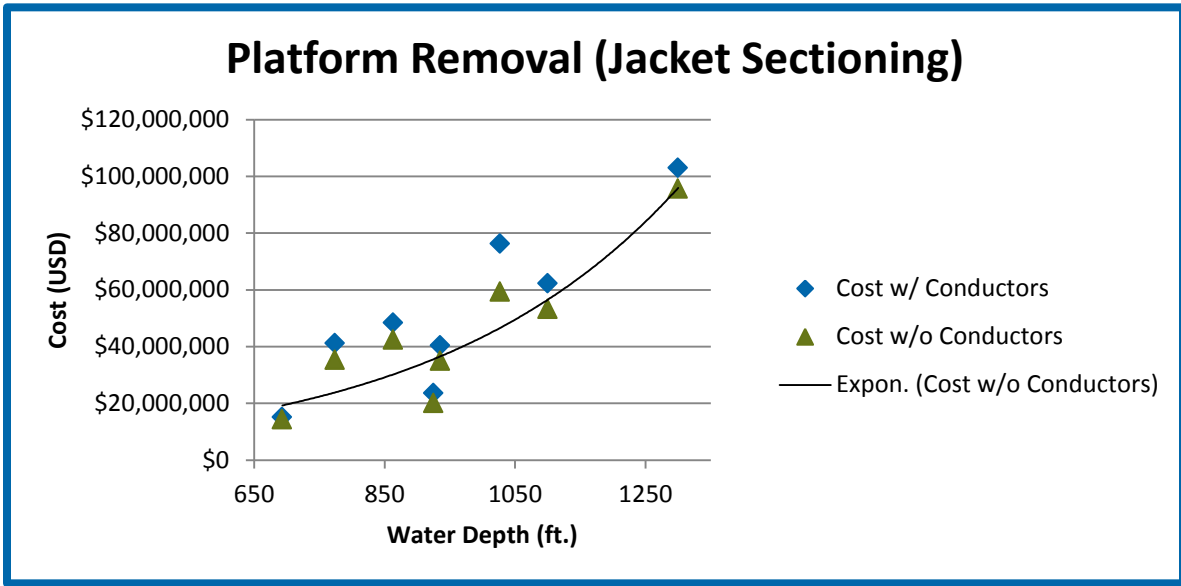

Figure 8-16. Platform Removal Costs, Jacket Sectioning

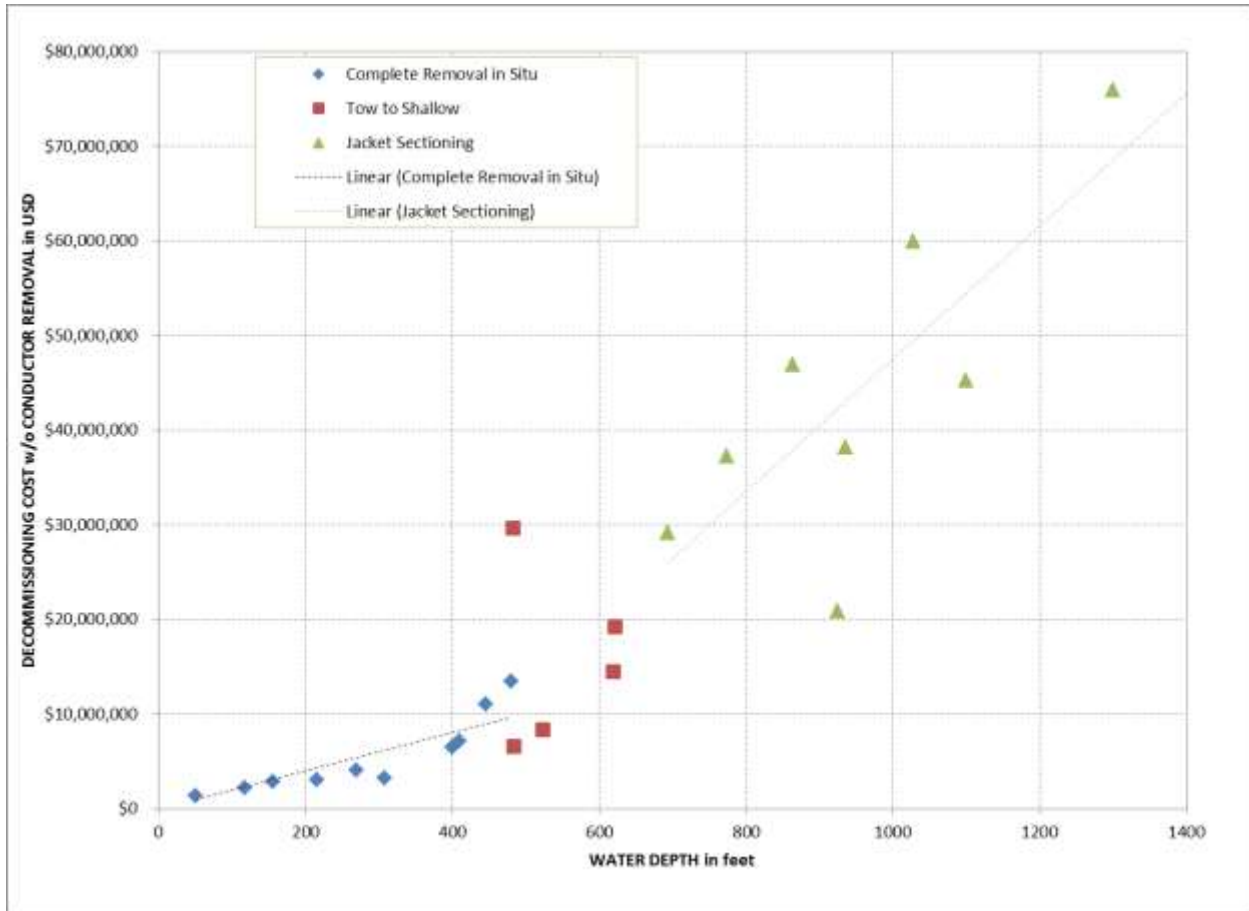

Figure 8-17. Estimated Platform Removal Costs w/o Conductor Costs

### 8.3.6.2. Spar Decommissioning Costs

#### 8.3.6.2.1 Preparation Costs

The Spar deck for the estimate below was installed on the hull after hull installation so the cost estimate is based on the platform preparation and deck removal being done offshore. The cost of platform preparation depends on the extent of production equipment; whether the facility handles gas, oil or both; and preparation costs for similar facilities. Spar platform preparation is presented in Table 8-9 and without further information could be estimated on a deck tonnage basis. With a representative Spar deck weight of 17,210 st an estimated preparation cost including 8% engineering costs would be \$932,015 or \$54.2 per st.

**Table 8-9. Spar Platform Removal Preparation**

Platform Removal Prep Task Description	Hours	Days	Cost
Flush, Purge and Clean Facilities, Tanks and Vessels	240	10	\$266,290
Prepare Modules for Removal	96	4	\$106,516
Prepare Mooring Anchors	504	21	\$559,209
<b>Spar Platform Removal Preparation Subtotal</b>	<b>840</b>	<b>35</b>	<b>\$932,015</b>

#### 8.3.6.2.2 Deck Removal Costs

The primarily cost driver in deck removal is the HLV selected for deck removal and is dependent on the weight and configuration of the deck. The decommissioning cost using a 5,000 st or less HLV is estimated at \$22.6 MM and where an HLV with capacity greater than 5000 st is needed the decommissioning cost is estimated at \$29.79 MM, as shown in Table 8-10 and Table 8-11.

**Table 8-10. Spar Deck Removal using HLV ≤ 5000 st**

SPAR Topsides Removal Task Description	Hours	Days	Cost
Cargo Barge Grillage and Tie-down Material	0	0	\$400,000
Mobilize SSCV (DP type vessel) 5000 st	24	1.0	\$657,504
Set-up DP SSCV vessel	4	0.2	\$109,584
Mobilize Cargo Barges for Equipment and Deck	33	1.4	\$32,340
Rig & Remove Topside Equipment	180	7.5	\$5,107,680
Rig & Remove Deck	360	15.0	\$10,215,360
Demobilize Cargo Barges with Equipment and Deck	33	1.4	\$32,340
Demobilize SSCV (DP type vessel)	24	1.0	\$657,504
Work Contingency			\$2,314,894
Weather Downtime			\$3,086,525
<b>Spar Topsides Removal Subtotal</b>	<b>658</b>	<b>27.5</b>	<b>\$22,613,730</b>

**Table 8-11. Spar Deck Removal using HLV > 5000 st**

SPAR Topsides Removal Task Description	Hours	Days	Cost
----------------------------------------	-------	------	------

Cargo Barge Grillage and Tie-down Material	0	0	\$400,000
Mobilize SSCV 7000 (DP type vessel)	24	1.0	\$877,896
Set-up DP SSCV vessel	4	0.2	\$146,316
Mobilize Cargo Barges for Equipment and Deck	33	1.4	\$32,340
Rig & Remove Topside Equipment	180	7.5	\$6,760,620
Rig & Remove Deck	360	15.0	\$13,521,240
Demobilize Cargo Barges with Equipment and Deck	33	1.4	\$32,340
Demobilize SSCV (DP type vessel)	24	1	\$877,896
Work Contingency			\$3,064,226
Weather Downtime			\$4,085,635
<b>Spar Topsides Removal Sub Total</b>	<b>658</b>	<b>27.5</b>	<b>\$29,798,510</b>

### 8.3.6.2.3 Platform and Mooring System

Platform preparation, mooring line disconnection and towing are estimated at \$7.3 MM for a Spar in 5,000' water depth as shown in Table 8-12.

**Table 8-12. Spar Hull Disconnect and Removal**

<b>SPAR Hull Removal/Tow Task Description</b>	<b>Hours</b>	<b>Days</b>	<b>Cost</b>
Route Survey	48	2	\$30,000
Mobilize DB2000, cargo barge and tug	24	1	\$224,520
Mobilize Tow Tugs (4-12000 HP)	48	2	\$280,000
Secure Tow Tugs to top of Hull	6	0	\$91,130
Ballast to relieve tension on Mooring lines	24	1	\$364,520
Sever lower chain from mooring system. Sever lower chain from cable and remove chain @ 8 hours each	96	4	\$1,458,080
Remove Mooring lines from Hull, by rigging to upper cable/chain connections. ROV sever upper chain from cable. Move away from Hull and lower cable to mudline @ 8 hours per line.	96	4	\$1,458,080
Prepare Hull for transportation	48	2	\$729,040
Release Hull from Derrick Barge to Tow Tugs	4	0	\$60,753
Demobilize Derrick Barge	0	0	\$224,520
Tow Hull to Onshore Location	48	2	\$280,000
Demobilize Tow Tugs	24	1	\$140,000
Work Provision			\$670,741
Weather Contingency			\$894,321
Project Management and Engineering			\$427,251
<b>SPAR Hull Removal/Tow Subtotal</b>	<b>466</b>	<b>19</b>	<b>\$7,332,956</b>

The anchor chain, cable or polyester line mooring assemblies are severed from the pile system and removed. The cost estimate assumes that the pile system would be allowed to remain in place. The chains are removed during the hull removal operation above and the cables are removed as described

below. The mooring system estimated in Table 8-12 consists of 12 lines. Since the spool capacity of the vessel would typically be limited to 2 cables at this depth, the vessel would have to make 6 trips to transport the 12 cables. Table 8-13 presents additional detail on the costs for mooring cable removal. An anchor handling vessel with ROV would mobilize and hook up to two mooring cables, reel the cables onboard, demobilize, and unreel the cables at a shore facility. At a water depth of 5,000 ft, the marginal cost of severing and removing one mooring line is about \$238,000 or a unit cost of about \$47 per line per foot of water depth. This unit cost would be applicable to all SPARs in the GOM.

**Table 8-13. Spar Mooring Line Removal**

Mooring Line Removal Task Description	Hours	Days	Cost
Mobilize Anchor Handling Supply Vessel (AHSV)	24	1	\$98,000
Locate and rig to 2 Mooring Cables	2	0	\$8,167
Separate cable from lower chain and spool up cable on AHSV	17	1	\$67,559
Demobilize AHSV to Unspooling Site	24	1	\$98,000
Unspool Drums	15	1	\$59,392
Project Management and Engineering (8%), Work Provision (15%), and Weather Allowance (20%)			\$142,381
<b>Spar Mooring Line Removal Subtotal</b>			<b>\$473,499</b>

### 8.3.6.3. MTLP & TLP Decommissioning Costs

#### 8.3.6.3.1 Preparation Costs

The cost of platform preparation depends on the extent of production equipment; whether the facility handles gas, oil or both; and preparation costs for similar facilities. Platform preparation could be performed near shore or offshore. Data for near shore platform preparation was not available. Conservatively, offshore costs are included here. TLP platform preparation is presented in Table 8-14 and without further information could be estimated on a cost per deck tonnage basis. Assuming a TLP deck weight of 8,100 st, the estimated preparation cost including engineering costs would be \$812,000 or \$100 per st.

**Table 8-14. MTLP/TLP Removal Prep**

Platform Removal Prep Task Description	Hours	Days	Cost
Flush, Purge and Clean Facilities, Tanks and Vessels	101	4	\$123,342
Prepare Modules for Removal	60	3	\$73,273
Replace Tension Units for Tendons	504	21	\$615,489
<b>Platform Removal Prep Subtotal</b>	<b>665</b>	<b>28</b>	<b>\$812,104</b>

#### 8.3.6.3.2 MTLP Deck Removal Costs

MTLPs are assumed to be insufficiently stable to support the deck weight after the mooring system is severed, therefore MTLP decks are assumed to be removed offshore. The primary cost driver in deck removal is the HLV selected for deck removal and is dependent on the weight and configuration of the

deck. The decommissioning cost using a 5,000 st or less HLV is estimated at \$2.0 MM and whereas the cost for a >5,000 st HLV is estimated at \$3.9 MM, as shown in Table 8-15 and Table 8-16.

TLP's were assumed stable to support the deck weight after the mooring system is severed, therefore the TLP decks are assumed to be transported with the hull to a shore facility.

**Table 8-15. MTLP Deck <5000 st Deck Removal**

<b>MTLP Deck &lt;5000 st Removal Task Description</b>	<b>Hours</b>	<b>Days</b>	<b>Cost</b>
Mobilize Derrick Barge Spread (DB4000 & CB 400)	24	1	\$467,240
Rig up to deck	6		\$116,810
Sever, Remove Deck & Sea fasten	36	2	\$700,860
Demobilize Derrick Barge Spread	24	1	\$467,240
Work Contingency	5		\$105,129
Weather Downtime	7		\$140,172
<b>Platform Removal Subtotal</b>	<b>103</b>	<b>4</b>	<b>\$1,997,451</b>

**Table 8-16. MTLP Deck >5000 st Deck Removal**

<b>MTLP Deck &gt;5000 st Removal Task Description</b>	<b>Hours</b>	<b>Days</b>	<b>Cost</b>
Mobilize Derrick Barge Spread (SSCV 7000 & CB 400)	24	1	\$781,640
Rig up to Deck	8		\$260,547
Sever, Remove Deck & Seafasten	48	2	\$1,563,280
Demobilize Derrick Barge Spread	24	1	\$781,640
Work Contingency	7		\$234,492
Weather Downtime	10		\$312,656
<b>Platform Removal Subtotal</b>	<b>121</b>	<b>5</b>	<b>\$3,934,255</b>

### 8.3.6.3.3 MTLP Platform and Mooring System

Tendon disconnection and removal and deck/hull towing are estimated at \$6 MM for a MTLP in 1,700' of water depth as shown in Table 8-17. The tubular tendon mooring assemblies would be severed from the pile system and removed. The pile system would be allowed to remain in place for the purpose of this estimate. The mooring system estimated in Table 8-17 consists of 6 tendons. The cost is broken down to a hull removal cost of \$5.25 MM exclusive of the tendon costs and a tendon severing and removal cost of \$750,210. At 6 tendons, this would generate a severing and removal cost of \$125,035 per tendon for this platform or \$73 per tendon per foot of water depth. The \$73/ft cost would be applicable to all MTLPs in the GOM. The hulls will be towed to a scrap or refurbishment facility.

**Table 8-17. MTLP Tendon & Hull Disconnect and Removal**

<b>MTLP Hull Removal/Tow Task Description</b>	<b>Hours</b>	<b>Days</b>	<b>Cost</b>
Route Survey	48	2	\$30,000
Mobilize Derrick Barge DB 2000	24	1	\$224,520
Mobilize 3 Tow Tugs	24	1	\$105,000
Mobilize Cargo Barges	36	2	\$141,120
ROV Sever and Remove 3 Tendons From TLP at 400 ft hour	26	1	\$375,105

<b>MTLP Hull Removal/Tow Task Description</b>	<b>Hours</b>	<b>Days</b>	<b>Cost</b>
and load on Cargo Barge @ 8 hours each			
Secure TLP to Derrick Barge	6	0	\$88,260
Secure Tow Tugs to TLP	6	0	\$88,260
ROV Sever and Remove 3 Tendons From TLP at 400 ft hour and load on Cargo Barge @ 8 hours each	26	1	\$375,105
Release TLP to Tow Tugs	4	0	\$58,840
Tow TLP to Onshore Location	192	8	\$2,824,320
Demobilize Cargo Barge	36	2	\$141,120
Demobilize Derrick Barge	24	1	\$224,520
<b>Subtotal</b>			\$4,676,170
Work Contingency (15%)	46	2	\$571,484
Weather Downtime (20%)	61	3	\$761,978
<b>Platform Removal Subtotal</b>	<b>558</b>	<b>23</b>	<b>\$6,009,632</b>
Engineering and Project Management (8%)			\$480,771
<b>Total</b>			<b>\$6,490,403</b>

#### 8.3.6.3.4 TLP Platform and Mooring System

Tendon disconnection and removal and deck/hull towing are estimated at \$10.4 MM for a TLP in over 3,000 ft of water as shown in Table 8-18. The tubular tendon mooring assemblies would be severed from the pile system and removed. The pile system would be allowed to remain in place for the purpose of this estimate. The mooring system estimated in Table 8-18 consists of 12 tendons. The cost is broken down to a deck/hull removal cost of \$4.3 MM exclusive of the tendon costs and a tendon severing and removal cost of \$3.1 MM (before Eng/PM, work provision and weather contingency). At 12 tendons, this would generate a severing and removal cost of \$258,693 per tendon for this platform or \$86 per tendon per foot of water depth. The \$86/ft cost would be applicable to all TLPs in the GOM. The hulls will be towed to a scrap or refurbishment facility.

**Table 8-18. TLP Tendon & Hull Disconnect and Removal**

<b>TLP Hull Removal/Tow Task Description</b>	<b>Hours</b>	<b>Days</b>	<b>Cost</b>
Route Survey	48	2	\$30,000
Mobilize Derrick Barge DB 2000	24	1	\$224,520
Mobilize 4 Tow Tugs	24	1	\$140,000
Mobilize Cargo Barges	36	2	\$141,120
ROV Sever and Remove 4 Tendons From TLP at 400 ft hour and load on Cargo Barge @ 16 hours each	64	3	\$1,034,773
ROV Sever and Remove 4 Tendons From TLP at 400 ft hour and load on Cargo Barge @ 16 hours each	64	3	\$1,034,773
Secure TLP to Derrick Barge	6	0	\$97,010
Secure Tow Tugs to TLP	6	0	\$97,010
ROV Sever and Remove 4 Tendons From TLP at 400 ft hour and load on Cargo Barge @ 16 hours each	64	3	\$1,034,773
Release TLP to Tow Tugs	4	0	\$64,673

TLP Hull Removal/Tow Task Description	Hours	Days	Cost
Tow TLP to Onshore Location	192	8	\$3,104,320
Demobilize Cargo Barge	36	2	\$141,120
Demobilize Derrick Barge	24	1	\$224,520
<b>Subtotal</b>			\$7,368,612
Work Provision (15%)	67	3	\$970,100
Weather Contingency (20%)	90	4	\$1,293,474
<b>Platform Removal Subtotal</b>	<b>749</b>	<b>31</b>	<b>\$9,632,186</b>
Engineering and Project Management (8%)			\$770,575
<b>Total</b>			<b>\$10,402,761</b>

### 8.3.6.4. Semi-submersible Decommissioning Costs

#### 8.3.6.4.1 Preparation Costs

Since the deck is an essential part of the structure, platform preparation can be performed dockside or offshore. To date, these large structures have not been decommissioned and appropriate onshore preparation costs have not been established. The representative SEMI structure has an estimated 20,000 st deck weight. Using the estimated preparation cost developed for Spar platforms of similar deck weight deck, a preparation cost of \$54.2/st would be appropriate for offshore preparation, or \$1,084,000 for the example 20,000 st deck. Onshore costs should be lower because marine assets would not be required during preparation operations.

#### 8.3.6.4.2 Platform and Mooring System

Platform preparation, mooring line disconnection and towing are estimated at \$6.3 MM for a SEMI in 6000 feet water depth as shown in Table 8-19. The anchor chain / cable or polyester mooring assemblies would be severed from the pile system and removed and, but for the purpose of this study the pile system would be allowed to remain in place. (Waiver could be applied as directed in 30 CFR 250.1728)

The chains are removed during the hull removal operation and the cables are removed as described below. The mooring system estimated in Table 8-19 consisted of 16 lines. The cost is broken down to a hull removal cost of \$2.48 MM and a chain mooring line severing and removal cost of \$3.8 MM (before Eng/PM, work provision and weather contingency). At 16 mooring lines, this would generate a severing cost of \$243,013 per mooring line or \$40 per line per foot of water depth. This would be applicable to all SEMIs in the GOM. Costs for the removal of two mooring cables are shown in Table 8-20.

**Table 8-19. SEMI Platform Removal**

SEMI Removal Task Description	Hours	Days	Cost
Mobilize Tugs (4-12000 HP)	48		\$280,000
Prepare facilities for tow.	168	7	\$289,107
Mobilize DB2000, cargo barge and tug	24	1	\$224,520
Secure Tow Tugs to top of Hull	6	0	\$91,130

<b>SEMI Removal Task Description</b>	<b>Hours</b>	<b>Days</b>	<b>Cost</b>
Ballast to relieve tension on Mooring lines	24	1	\$364,520
Sever lower chain from mooring system. Sever lower chain from cable and remove chain @ 8 hours each	128		\$1,944,107
Remove Mooring lines from Hull, by rigging to upper cable/chain connections. ROV sever upper chain from cable. Move away from Hull and lower cable to mudline @ 8 hours per line.	128	5	\$1,944,107
Demobilize DB2000, cargo barge and tug	24	1	\$224,520
Tow facilities to Ingleside facility	93	4	\$542,500
Mothball facilities onshore	168	7	\$186,403
Demobilize Tugs	48		\$280,000
<b>Platform Removal Prep Subtotal</b>	<b>763</b>	<b>26</b>	<b>\$6,370,913</b>

An anchor handling vessel with ROV mobilizes and hooks up to a mooring cable and reels the cable onboard. If space is available, remove a second cable. Demobilize and unreel the cable(s) at a shore facility. The process is repeated until all 16 lines are removed for a total cost of \$3.88 MM including Project Management and Engineering of 8%, Work Provision of 15% and Weather Contingency of 20%. Costs for the removal of two mooring cables are shown in Table 8-20.

**Table 8-20. SEMI Mooring Line Removal**

<b>Mooring Line Removal Task Description</b>	<b>Hours</b>	<b>Days</b>	<b>Cost</b>
Mobilize Anchor Handling Supply Vessel (AHSV)	24	1	\$97,992
Locate and rig to 2 Mooring Cables	2	0	\$8,166
Separate cables from lower chains and spool up cables on AHSV	21	1	\$84,040
Demobilize AHSV to Unspooling Site	24	1	\$97,992
Unspool Drums	19	1	\$75,874
<b>Total for 2 Mooring Lines</b>			<b>\$364,064</b>

Mooring line removal costs for this representative SEMI are estimated to cost \$364,064 for two cable lines or \$30 per mooring line per foot of water depth. This cost would be applicable to other SEMIs in the GOM.

### 8.3.6.5. FPSO Decommissioning Costs

FPSOs in GOM (i.e. Petrobras at Chinook) are very rare and cost estimates for the removal of these platforms in the U.S. are not available. Internationally there are many types of FPSO designs with some permanently secured with multiple mooring lines and some permanently secured to single point mooring systems that allow the vessels to rotate with environmental conditions. Estimated or actual decommissioning costs are available for a few FPSOs, but the wide variance makes meaningful comparisons difficult.



An FPSO was decommissioned from offshore Malaysia at an actual cost of \$17.2 million, including removal of the FPSO, mooring chains, and subsea structures as well as capping the pipelines<sup>13</sup>. The cost for decommissioning the *BW Athena* FPSO which operates on the United Kingdom Continental Shelf (UKCS) is estimated to be \$94 million, but the majority of the costs are attributable to well P&A.<sup>14</sup> The estimated costs for the preparation, removal, and disposal of BP's 154,000 metric ton *Schiehallion* FPSO is reported to be \$125 million<sup>15</sup>. Table 8-21 presents actual cost data for the decommissioning of the *Sevan Voyageur* FPSO in the UKCS<sup>16</sup>.

**Table 8-21. Shelley FPSO Decommissioning Costs**

FPSO Decommissioning Activity	Cost (millions)
Remove subsea facilities	\$12.4
Remove the FPSO	\$12.7
Plug and abandon wells	\$23.9
Post-decommissioning surveys	\$ 0.8
<b>Total</b>	<b>\$49.8</b>

The mooring lines for an FPSO are removed in the same manner as the SEMI mooring system discussed above. The cost per mooring line per foot of water depth developed for SEMIs also applies to FPSOs.

### 8.3.7. Subsea Structure Decommissioning

Decommissioning subsea structures, wells, manifolds, jumpers, etc., involves removing everything to 15 feet below the mudline or leaving selected structures in place. For the purpose of the estimates presented herein, wells and structures that are stabbed over or attached above anchored templates are removed, but the anchored templates themselves are allowed to remain in place (waiver could be applied as directed in 30 CFR 250.1728.). Costs for removal of subsea structures with wells are included in the well P&A operations.

### 8.3.8. Site Clearance and Verification

Site Clearance costs are primarily a function of mobilization/demobilization distance, water depth, number of wells, and age of the facility. As each of these parameters increase, site verification and clearance costs increase. Table 8-22 presents estimated site clearance and verification costs for a floating platform in 3,000 to 5,000 feet of water. (See 30 CFR 250.1741 & 250.1742)

<sup>13</sup> World Oil, "IEV Malaysia completes FPSO decommissioning contract", 6 May 2014, <http://www.worldoil.com/news/2014/5/6/iev-malaysia-completes-fps-decommissioning-contract>

<sup>14</sup> Decomworld, "Updated Athena field decom cost estimates soar 66%, to £60m", 22 October 2014. <http://analysis.decomworld.com/structures-and-maintenance/updated-athena-field-decom-cost-estimates-soar-66-%C2%A360m>

<sup>15</sup> BP, "Schiehallion & Loyal Decommissioning Programmes Phase 1", April 2013.

<sup>16</sup> Premier Oil, "Shelley Field Decommissioning Programmes, Close Out Report", November 2012.

**Table 8-22. Site Clearance and Verification Costs**

Activity	Hours	Days	Cost
Mob Vessels to Site	24	1	\$66,800
Side Scan at Platform Location	24	1	\$66,800
Inspect and Clean up	48	2	\$133,600
Demob Vessels from Site	24	1	\$66,800
Weather Downtime		0	\$40,080
<b>Site Clearance Subtotal</b>	<b>120</b>	<b>5</b>	<b>\$374,080</b>

### 8.3.9. Decommissioning Cost Summary

Table 8-23 summarizes the decommissioning component costs for the asset types discussed above. Approximate decommissioning estimates can be obtained by summing the individual component costs for the appropriate assets using the indicated tables and figures and applying the Eng/PM, work provision, and weather contingency costs. These costs include removal of the assets from their offshore locations and transport to shore but do not include disposal costs. Excluding disposal costs is a common practice in the industry and a common assumption in determining decommissioning costs, normally Derrick Barge operator takes ownership and profits. Disposal costs are considered in cases where there is asbestos, scale (ex. barium sulfate), and/or Naturally Occurring Radioactive Maters (NORM).

**Table 8-23. Decommissioning Component Costs**

Decommissioning Activity	Reference	Typical Cost
Engineering and Project Management	Section 8.3.1.1	8% of costs w/ Mob/ Demob
Work Provision	Section 8.3.1.3	15% of costs w/o Mob/Demob (except 10% for Wet Tree Well P&A)
Weather Contingency	Section 8.3.1.2	20% of costs w/o Mob/Demob
Well P&A, Dry Tree, 50' to 400'	Section 8.3.2.1 Figure 8-5, Figure 8-6	\$350,000 per well
Well P&A, Dry Tree, > 400'	Section 8.3.2.2 Figure 8-7, Figure 8-8	\$480,000 to \$1.8 million per well
Well P&A, Wet Tree	Section 8.3.2.3 Figure 8-10	\$8 to \$16 million per well
Pipelines	Section 8.3.3 Table 8-5	\$15 to \$40 per foot, but highly variable
Umbilicals	Table 8-6, Figure 8-11	\$2 to \$10 per foot (length)
Conductors	Section 8.3.5 Figure 8-12	\$160,000 to \$600,000 per conductor
Fixed Platforms	Table 8-8 Figure 8-17	Without conductors, less than \$10 million for WD ≤ 500 ft, then add \$7 million per 100 ft WD
Spar Platforms	Section 8.3.6.2 Table 8-9, Table 8-10, Table 8-11, Table 8-12, Table 8-13	Preparation: \$54/st Mooring lines: \$47/ft of WD \$31 million to \$39 million

Decommissioning Activity	Reference	Typical Cost
MTLPs	Section 8.3.6.3 Table 8-14, Table 8-15, Table 8-16, Table 8-17	Preparation: \$100/st Tendons: \$73/ft of WD \$9 million to \$11 million total
TLPs	Section 8.3.6.3 Table 8-14 Table 8-18	Preparation: \$100/st Tendons: \$86/ft of WD \$11 million total
Semi-submersible Platforms	Section 8.3.6.4 Table 8-19, Table 8-20	Preparation: \$54/st Mooring lines: \$40/ft of WD \$15 million total
FPSOs	Section 8.3.6.5	Insufficient data
Subsea Structures	Section 8.3.7 Section 8.3.2.3	See Well P&A, Wet Tree costs
Site Clearance and Verification	Section 8.3.8	\$400,000, but sensitive to Mob/Demob costs Up to 1% of total costs

### 8.3.10. Material Disposal

Typically in the GOM, disposal location is usually not considered directly in decommissioning estimates. The derrick barge contractor usually takes possession of the structure when it is placed on the cargo barge and realizes any disposal costs or profits from the salvage of material. Therefore, disposal costs have already been included in the estimates for the removal of the various components. Disposal practices may vary in other parts of the world. Even though the salvage value or disposal cost is not borne directly by the platform owner, scrap steel prices affect the bid prices of the decommissioning contractors.

Estimates should be developed in a manner that satisfies the reporting and audit requirements of Financial Accounting Standards Board (FASB) Statement of Financial Accounting Standards No. 143, "Accounting for Asset Retirement" (SFAS 143); i.e., what a willing 3rd party would consider in today's costs with no future adjustments. By this standard, scrap credit values must be treated separately from decommissioning costs. Therefore, any credit for scrap is not included in the decommissioning estimates. Although there may be some value for processing, production and compression equipment, any revenue from the sale of such is generally ignored.

## 8.4. Comparisons of Actual and Estimated Decommissioning Costs

This section presents a comparison of actual platform removal cost compared to estimated costs. The data gathering portion of this study included soliciting decommissioning cost information from BSEE, industry sources, and foreign government sources; compiling actual decommissioning costs on as many facilities as feasible within the timeframe of this study; comparing actual decommissioning costs to estimated decommissioning costs; and calculating actual to estimated cost ratios.

Requests for actual decommissioning cost data were sent out globally to over 2,000 oil and gas offshore operators and service providers. Some operators were also contacted by phone to encourage data sharing or to follow-up on responses to the electronic requests. Fewer than a dozen operators – all operating in the Gulf of Mexico - responded that they would be willing to provide actual cost data. Some of those operators later declined to actually provide any data. However, actual cost data was received on more than 200 structures. Some of the data included both authorization for expenditure (AFE) costs and actual costs.

The cost data received varied in its completeness, level of detail, and usefulness. In analyzing the cost data received, only costs that itemized a breakout of platform, pipeline, and well costs were used. Actual cost data was compiled for a sampling of over 200 platforms in varying water depths and platform types. For each of these platforms, estimated costs were generated based on the platform type, water depth and location. In estimating the decommissioning cost for a particular structure, it is imperative that the type of platform and its characteristics are known; e.g., 4-pile in 150 water depth in Vermillion block 294. BSEE's predecessor agency, MMS, often provided that data. It would be very beneficial for BSEE to obtain and maintain that type of information on all platforms to assist in understanding decommissioning costs and bonding requirements.

TSB has used a proprietary estimating program Platform Abandonment Estimating System (PAES®) for over 30 years that tracks thousands of platforms of all types globally, documents the offshore decommissioning resource costs annually, and documents the estimated decommissioning cost for the year the estimate was generated. The estimates have been routinely benchmarked against actual removals in the GOM and adjusted accordingly. The current resource rates or those for any given past year can be reviewed and used. The basic platform characteristics (example) used to generate platform estimates using PAES are:

- Platform offshore block and identification (e.g., High Island A-477 A) or distance from shore base<sup>17</sup>
- Water depth
- Number of legs, piles and or skirt piles
- Diameter of piles
- Number of conductors (if present)
- Overall deck and jacket dimensions
- Overall deck and jacket lift weights
- Equipment installed on deck after initial deck installation and equipment lift weights

For fixed platforms, disposal location is usually not considered for decommissioning estimates. A common practice in the GOM is that the derrick barge provider takes possession of the removed platform, as is where is, upon seafastening to the cargo barge. The provider realizes any profit or loss between dismantlement and scrap value.

---

<sup>17</sup> Shore base is the location from which resources are mobilization

The data received from operators and service providers was evaluated and compared with known data from the PAES program. Where the above characteristics were provided, cost estimates were developed for comparison using resource costs for the year of actual decommissioning. Where the characteristics were not provided with actual costs, the PAES database was researched for available estimates and where a match was found with the above characteristics an estimate was generated using the resource costs for the year of decommissioning. Where the year of decommissioning was not provided in the data received, BSEE records were used to determine the year of decommissioning.

We have compiled actual cost data on 60 decommissioning projects. At many of these platforms, multiple decommissioning projects were performed. In total, we estimate that we have cost comparison data on over 200 decommissioned platforms.

The tables below present details on the structures for which we have obtained actual cost data and have developed estimated decommissioning costs. Note that all of the information pertains to fixed platforms in the Gulf of Mexico, largely because this is the area where most decommissioning has occurred and because older structures are primarily fixed platforms. The platform water depths range from 7 to 341 feet.

Table 8-24 lists the 21 structures for which we have the structure pile information in addition to the structure location, water depth, platform type, and decommissioning cost data. The cost data includes the estimated cost from TSB's Platform Abandonment Estimating System (PAES), the operator's AFE, and the actual decommissioning cost.

All costs in this section include estimated and actual costs and are based on information, durations and resource costs available at the time of this study. This study reviewed and applied the significant amount of technical and cost data compiled from previous studies on platforms for BSEE and from private companies that have been decommissioning in the Gulf of Mexico. The majority of the cost data pertains to platforms that were located in water depths of less than 400'. There is less data available on platforms in water depths greater than 400' because fewer decommissioning projects have occurred in those water depths in the Gulf of Mexico and dramatically fewer in other locations around the world. Due to confidentiality agreements between TSB and operators that provided cost data, the exact platform locations are not provided. The costs presented below are for the year of decommissioning.

**Table 8-24. Fixed Platforms with Actual and Estimated Removal Costs with Pile Information**

Location	Removal Date	Platform Piles	Water Depth (ft.)	Platform Abandonment Estimating System® Estimated Cost	Approval for Expenditure Estimate	Actual Cost
VR	3/18/2009	4	35	\$1,294,593	\$1,481,332	\$1,414,936
EI	9/12/2011	9	45	\$1,440,376	\$1,027,508	\$3,694,578
EI	5/7/2011	3	49	\$1,105,596	\$891,840	\$676,399
CA	8/28/2008	4	50	\$1,534,192	\$978,704	\$923,257

EI	5/10/2011	4	50	\$1,120,693	\$752,091	\$1,001,430
EI	8/5/2007	10	52	\$2,026,532	\$1,494,047	\$3,092,232
EI	8/1/2011	16	52	\$2,716,184	\$2,654,584	\$3,117,237
WC	11/4/2007	1	53	\$874,557	\$1,270,511	\$320,338
BA	10/25/2011	4	81	\$3,306,824	\$1,287,696	\$2,184,761
VR	11/5/2009	8	82	\$2,579,279	\$2,287,764	\$5,759,360
MP	4/25/2011	4	95	\$2,566,551	\$1,521,017	\$3,170,275
EI	9/26/2003	4	98	\$738,300	\$1,902,000	\$1,902,000
ST	7/20/2011	4	147	\$2,197,335	\$1,532,882	\$1,190,175
VR	3/27/2012	4	155	\$2,813,159	\$2,042,576	\$4,742,555
HI-A	10/6/2011	4	191	\$3,197,802	\$2,559,486	\$4,969,896
ST	6/16/2013	4	196	\$3,222,619	\$1,138,004	\$5,451,829
HI-A	10/31/2006	3	217	\$1,606,584	\$1,438,565	\$1,638,946
HI-A	9/3/2013	8	232	\$5,465,623	\$3,575,188	\$6,673,922
MP	7/8/2012	4	269	\$6,315,020	\$2,881,149	\$8,069,728
HI-A	9/5/2013	4	280	\$13,254,150	\$5,387,879	\$14,186,704
EC	6/13/2007	4	308	\$3,766,927	\$3,758,317	\$3,891,030

Table 8-25 presents information on a single decommissioning campaign involving approximately 200 structures at 39 locations. We have both estimated and actual cost data for this campaign, but only in the form of summary data at each location. For these platforms, we have structure location, water depth, and platform type, but we do not have detailed information on the number of platforms at each location or on the number of piles for each platform. However, TSB's predecessor company managed or was directly involved in the removal of these platforms and had the specific pile and platform information when the estimated decommissioning costs were calculated. Therefore the cost information is relevant for the purposes of the estimated and actual cost comparisons.

Table 8-25. Fixed Platforms with Actual and Estimated Removal Costs without Pile Information

Location	Removal Date	Water Depth (ft.)	Platform Abandonment Estimating System® Estimated Cost	Actual Cost
SS	1997	7	\$9,167,374	\$6,775,081
GA	1997	23	\$2,454,056	\$159,718
VR	1997	40	\$1,063,437	\$361,384
VR	1997	43	\$709,367	\$536,394
HI	1997	46	\$3,406,672	\$2,974,676
HI	1995	46	\$947,249	\$1,379,979
HI	1997	49	\$1,380,827	\$1,012,849
SS	2000	52	\$3,193,261	\$1,042,562
WC	1997	66	\$1,554,843	\$1,540,755
SM	2002	72	\$2,070,926	\$1,960,706
SM	2002	72	\$523,675	\$535,054
SS	2000	72	\$1,878,461	\$2,296,729
MU	1997	79	\$1,753,243	\$1,656,759
GA	1998	85	\$1,052,252	\$482,032
EC	2000	89	\$469,196	\$994,088
EC	2001	89	\$1,072,351	\$646,781
SM	2001	95	\$1,332,171	\$1,356,566
SS	2002	100	\$830,196	\$571,349
MI	1997	102	\$1,309,950	\$1,252,699
EC	2001	108	\$867,150	\$944,626
EC	2000	115	\$2,178,958	\$309,999
VR	2001	115	\$996,444	\$1,145,719
MU	1992	118	\$1,158,906	\$1,673,999
WD	1996	128	\$1,261,673	\$688,780
EI	1998	161	\$709,789	\$324,706
HI A	1998	167	\$594,094	\$873,678
HI A	1995	167	\$1,675,823	\$1,271,449
WC	1996	187	\$601,868	\$565,731
WC	2001	190	\$2,207,850	\$1,175,320
EI	1996	194	\$2,173,176	\$1,368,956
HI A	1995	194	\$552,830	\$736,646
EI	2009	197	\$2,239,885	\$1,959,434
VR	1995	197	\$3,331,889	\$4,400,349
VR	1998	203	\$2,916,729	\$2,434,843
HI A	1992	210	\$426,996	\$690,169
HI A	2001	210	\$741,307	\$807,111
EI	1995	312	\$1,043,207	\$2,242,102
VR	1991	340	\$1,099,220	\$1,766,339
EI	1997	341	\$1,932,884	\$2,111,971

Combining the costs from Table 8-24 and Table 8-25, Figure 8-18 shows the estimated and actual decommissioning costs for over 200 fixed platforms in the Gulf of Mexico.

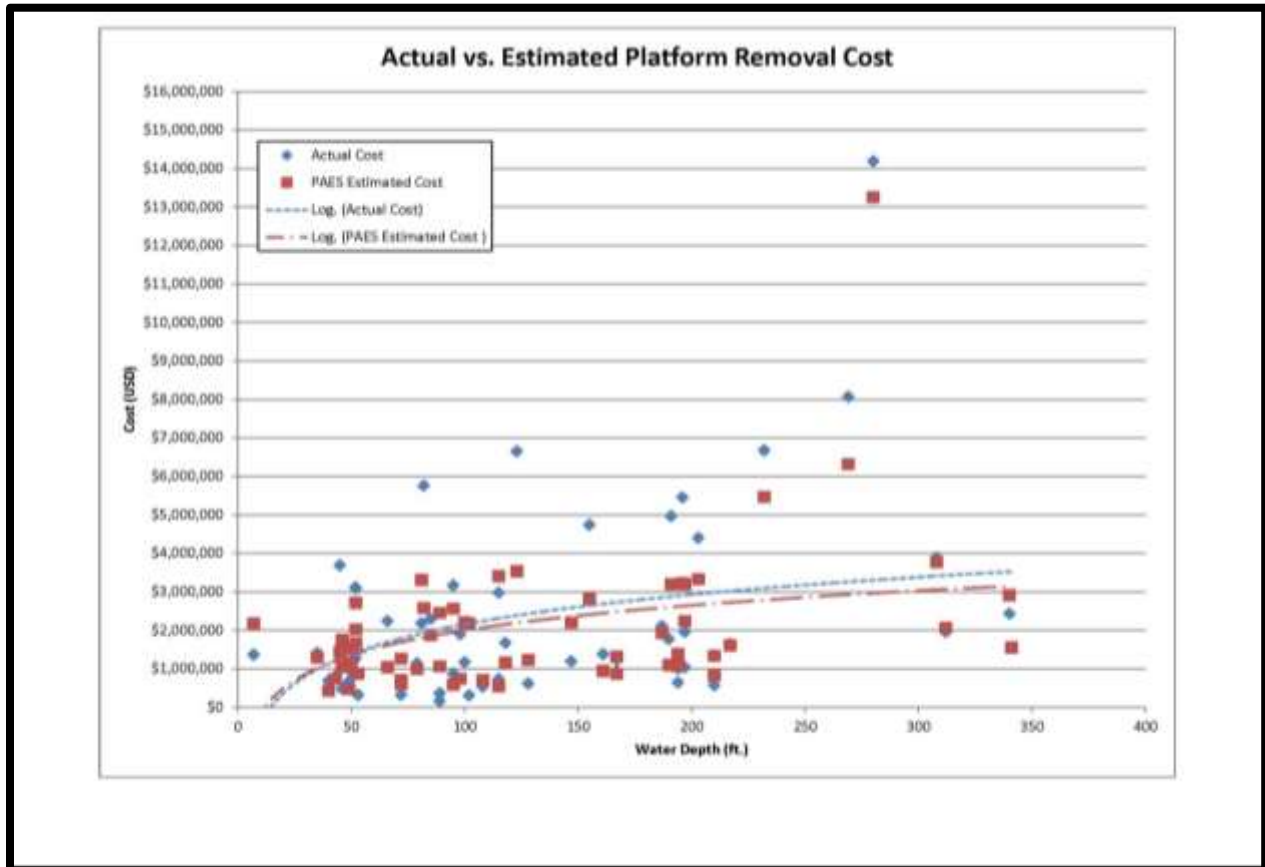
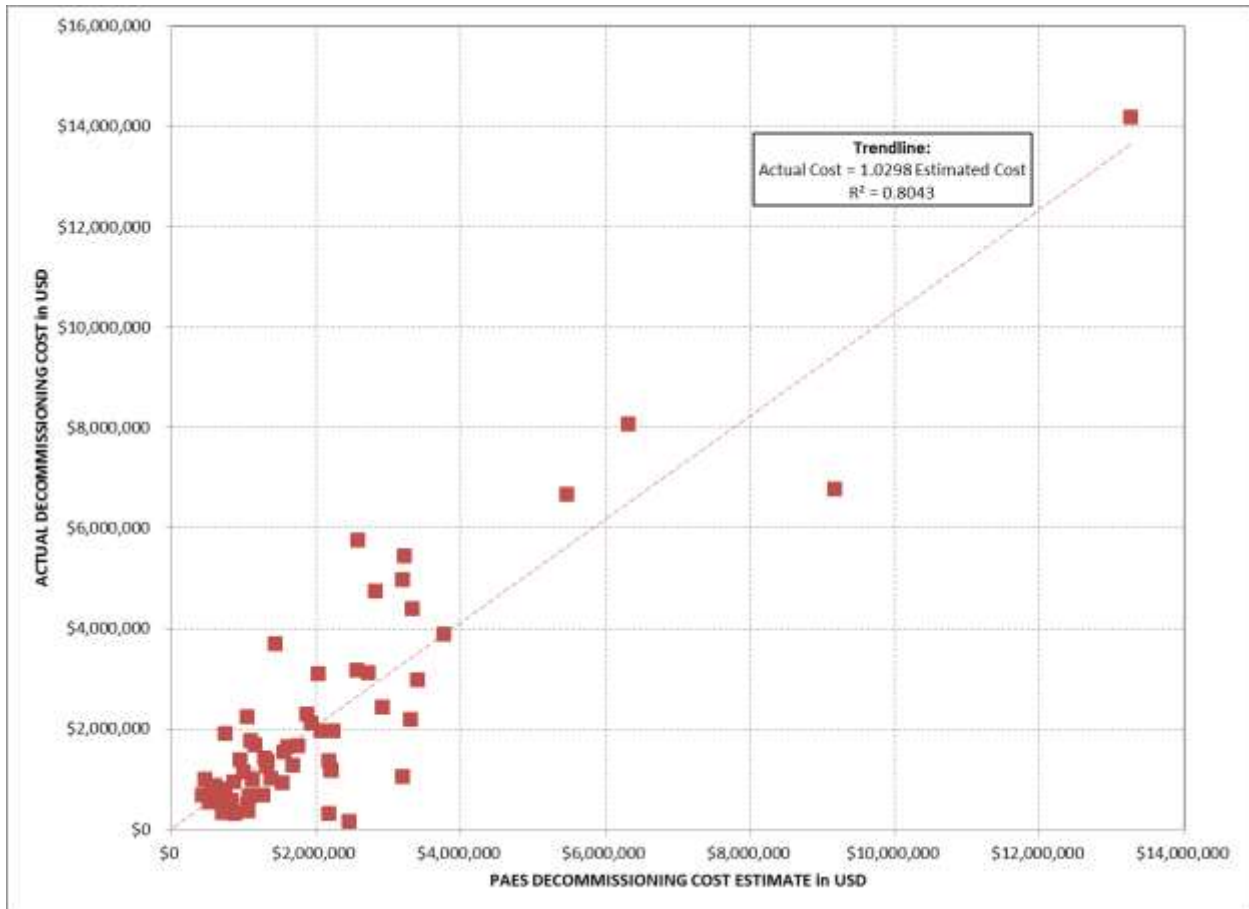

**Figure 8-18. Actual and Estimated Platform Removal Costs**

Figure 8-19 illustrates the correlation between the PAEs estimated decommissioning costs and the actual decommissioning costs for the platforms in Table 8-24 and Table 8-25. The equation for the trendline shows that the actual cost tends to be about 3% greater than the estimated cost.

The mean of the actual to estimated cost ratio (AEC ratio) is 1.066, indicating that the actual cost is, on average, 6.6% higher than the estimated cost. However, the dataset displays a fair amount of scatter. For example, the standard deviation of the AEC ratio is 0.54, meaning that approximately one third of the estimates either underestimate or overestimate the actual cost by more than 50%. The range of actual costs is from 6.5% to 258% of the estimated costs meaning that at least some of the estimated costs overestimated the actual costs by as much as 93.5% of the estimated costs and underestimated the actual costs by as much as 158% of the estimated costs.





**Figure 8-19. Actual vs. Estimated Platform Removal Costs**

Analyzing the same data in terms of AEC differentials instead of AEC ratios shows the cost difference between the estimated and actual costs. Specifically, Figure 8-20 shows the dollar amount by which the actual decommissioning costs exceeded the estimated decommissioning costs for each of the 60 cases in Table 8-24 and Table 8-25. Note that in nearly every case, the actual cost was no more than about \$2 million above the estimated cost.

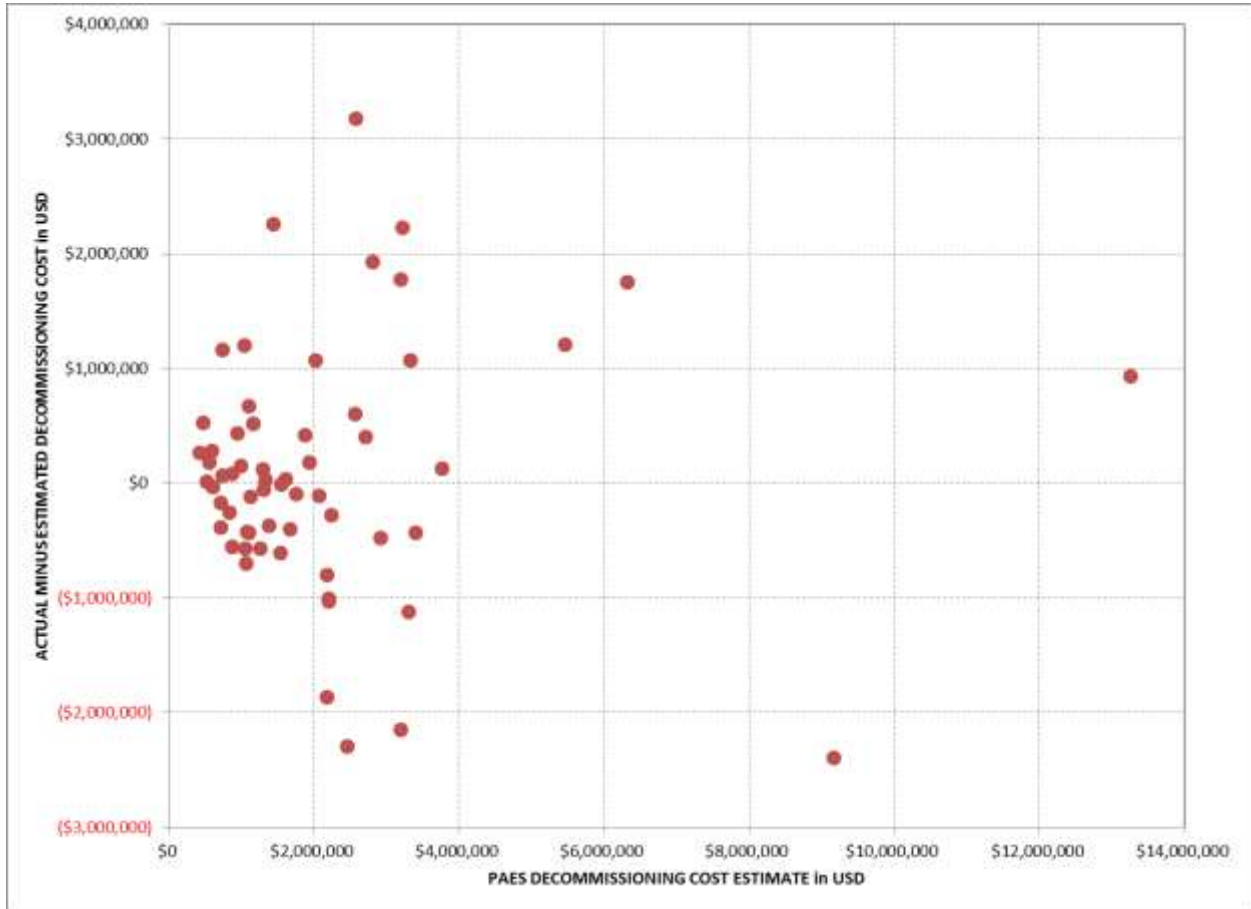

Figure 8-20. Actual Minus Estimated Platform Removal Costs

## 9. Contingencies and Uncertainties Impacting Cost Estimating

### 9.1. Introduction

All cost estimates for major projects incorporate assumptions that may or may not prove to be accurate when the work is actually performed. This is true in decommissioning offshore facilities. We distinguish between contingencies and uncertainties as follows:

- Contingencies are defined as cost categories that are reasonably likely or certain to occur but whose costs may be highly variable or difficult to estimate. Examples of contingencies include project management, weather impacts, and unforeseen or unknowable decommissioning complications. Contingency costs can be estimated based on the ranges of similar costs on past projects.
- Uncertainties are defined as events or conditions which are possible but which have a low probability of occurrence. Examples of uncertainties include labor strikes, interference by third parties, serious environmental or safety incidents, contractor defaults, and loss of key personnel or major equipment. The potential costs for uncertainties are difficult to quantify because of their low frequency of occurrence and because of the unknown magnitudes or durations of the triggering events.

All contingencies and uncertainties that actually occur cause work delays and added costs. The following sections list specific contingencies commonly used in decommissioning estimates and list a number of uncertainties that may be experienced. The range of uncertainties is not exhaustive as these are primarily speculative.

### 9.2. Contingencies

Contingency costs can be estimated based on predictions of their probability of occurrence and an analysis of the ranges of similar costs on past projects. The following are examples of contingencies that are commonly planned for or estimated. Although the estimates or ranges presented below are based on years of experience and historical price data, in any particular case the contingency costs may exceed these estimates.

#### 9.2.1. Engineering & Project Management

Every decommissioning project requires a significant amount of engineering analysis and review to plan how the project can best be accomplished. The amount of engineering labor required depends on many details of the platform to be decommissioned and on a number of market conditions including the availability of specialized equipment. The project management costs depend on the size of the overall decommissioning effort and can vary based on the duration of the project, the size of the labor force, the number of subcontractors, and other factors. Many of these factors are not well known until the engineering details of the decommissioning have been determined and even then may change during decommissioning if complications arise.

Engineering & project management (E&PM) costs have been studied by the oil and gas industry. A 2011 review of nearly 50 oil and gas capital projects analyzed the project management costs as a percentage of the capital expenditures (CAPEX). The values of the projects ranged from about \$50 million to over \$4 billion, significantly larger than the average decommissioning project. Project management costs were believed to normally range from 8% to 16% with lower percentages attributed to larger projects. Although about half of the projects fell within this range, the review found that actual project management costs ranged from as low as 2% to as high as 26%. Some of the highest percentages were related to the most expensive projects, not solely with the smaller projects as expected.<sup>18</sup>

The review concluded that lower project management costs are incurred on projects with which operators have the most experience, and that costs increase for more novel or more complex projects. Other factors that contributed to higher project management costs included multiple ownership or responsibility, poorly developed regional infrastructure, use of innovative technology, and fast-tracking the project schedule.

In 2013, the Performance Forum prepared an internal study for its oil and gas industry members on the actual costs of removing steel structures from the North Sea. It found that project management costs averaged about 8% of the total decommissioning cost. Including the costs for detailed engineering increased the total E&PM cost to 22%.<sup>19</sup>

A similar project management cost study reported by TSB in 2014 analyzed the planning, permitting, engineering and site supervision costs on 55 offshore decommissioning projects performed between 1994 and 2005. The study determined that the median project management cost equaled 8.8% and that PM costs for over 80% of the projects fell between 4.5% and 15%. These costs did not include any overhead or supervision costs incurred by the owner or operator.<sup>20</sup>

For offshore decommissioning, an average of 8% of total project cost has been historically used to estimate E&PM costs in the GOM. Although these costs are at the low end of the ranges discussed above, they reflect the fact that most of the decommissioning work in the GOM has been performed on similar structures, e.g. caissons and steel jacket platforms, in relatively shallow waters (< 400 ft). This has allowed the decommissioning industry to become increasingly efficient in designing and managing these decommissioning projects. As decommissioning work extends out into deeper waters and involves less common structures (TLPs, FPSOs, SEMIs, etc.) or for decommissioning work in other areas around the globe that present additional logistical challenges, the E&PM costs would be expected to increase.

---

<sup>18</sup> Jamieson, Aileen, "Analysing project management costs", Turner & Townsend, 2011.  
<http://www.turnerandtowntsend.com/889/11364.html>

<sup>19</sup> Jamieson, Aileen, "The cost of decommissioning North Sea platform", Offshore Technology International, 2013.  
<http://www.offshore-publication.com/technology/1036-decommissioning-north-sea-platforms-329408234>

<sup>20</sup> Byrd, Dr. Robert C., Miller, Donald J., and Wiese, Steven M., "Cost Estimating for Offshore Oil & Gas Facility Decommissioning", 2014 AACE® International Technical Paper, 2014.

Regardless of the project, there are certain E&PM functions that must be performed. A small project like a caisson removal would tend to have lower E&PM costs than the average but it would be a higher percentage of the total cost. The reverse is true, for larger projects like removing an 8-pile structure in deep water or removing multiple structures, pipelines or wells, the E&PM costs would be higher but the percentage of the total would tend to be lower than the average, provided that the project did not present unusual novelty or complexity. The remoteness of a project impacts the E&PM costs as well. A long term project in a remote location requires a higher cost for placement of resources on location and for travel costs. In these cases, a higher E&PM contingency should be applied.

### 9.2.2. Weather Allowance

Weather can have an important influence on offshore operations but the weather that will occur during a planned decommissioning schedule cannot be forecast with certainty. However, the statistical frequency of weather events that would impact decommissioning costs can be determined. A weather allowance percentage is included in decommissioning cost estimates to compensate for delays caused by regular weather and for tropical storms.

For estimating offshore decommissioning work, a weather allowance of 20% is typically included, consisting of 14% for regular weather delays and 6% for delays from named tropical storms. These percentages were developed based on project weather delays that have been tracked and documented in the GOM.

Careful planning and timing for short projects like caissons or single platforms might reduce weather delays, especially as long range weather forecasts improve, but operators have testified before FERC that they cannot realistically plan around the weather for the decommissioning of multiple structures, pipelines or numerous wells. Operators usually request decommissioning estimates or asset retirement obligations (AROs) for their entire offshore inventory or for an entire region and a standard 20% weather allowance is used in the estimates. Outside of the hurricane season, regular weather would be anticipated. Pipeline abandonment is dependent on divers and smaller vessels, such as workboats and 4-point diving vessels which are more weather impacted than DP vessels. DP and intervention vessels with heave-compensated cranes can weather greater seastates than smaller vessels. Liftboats can jackup and thereby continue working in greater seastates, but only to the extent that the servicing vessels can operate and supply needed material. Projects on a platform structure such as well P&A and platform preparation are not directly impacted by regular weather, but the weather may impact workboats servicing the project.

In areas with seasonal weather fluctuations, such as hurricane season in the Gulf of Mexico, winter offshore of Alaska, or the monsoon season in Thailand, scheduling decommissioning work during seasons with more favorable weather may reduce delays and related costs. In areas where seasonal marine migration occurs, additional planning is required to mitigate potential impacts to the marine population.

Sea currents impact working conditions for all operations where vessels, divers or ROVs are used. For example, the Cook Inlet in Alaska has large tidal movements that impact the ability to stay on-station and dramatically raise and lower the waterline. Off the west coast of India, strong currents restrict diving operations to short work windows. Estimates need to factor in the additional time required to complete operations under these local conditions.

Weather contingencies can be estimated for other regions that have sufficient meteorological and oceanographic (metocean) data if the operational constraints of the planned resources are clearly defined. Metocean data includes weather information (prevailing winds, gust speeds, and storm information), sea state (swell, wave height, and wave frequency), tides, and currents. Comparing the operational limitations for a vessel (heave, wind speed for lifting operations) to the historical data, the weather contingency percentage can be estimated as the amount of time operations cannot be performed divided by the planned work time in the absence of weather delays. This can be a time and labor intensive process that depends on the availability of accurate metocean information and equipment operational constraints and requires a breakdown of each activity. The weather allowance contingency could vary significantly depending on a company's risk tolerance and operational practices.

### 9.2.3. Work Contingencies

Work Contingencies include extra costs from possible delays or deviations from the expected scope of work due to lack of information and may be added to an estimate when there is uncertainty in the work scope. Note that a Work Contingency differs from the Work Provision in that Work Provision is not extra work, but includes all of the minor activities necessary for actual removals that are not currently itemized in the major task estimates.

It is not uncommon to have incomplete information at the time of decommissioning. Any percentage applied for work contingencies is determined based on the quality and completeness of the information and how well defined the decommissioning operations are. The work contingency should be estimated separately by class of operations and is based on the potential for problems in areas where there are data gaps. For example, if the current condition of wells scheduled for P&A is not known, a work contingency may be added to allow for delays caused by problem wells.

The work contingency for a platform well P&A would be different than removing a deep water jacket by jacket sectioning. The range of values used is normally between 10% and 20%. Higher work contingency would be added for less defined operations.

The following examples describe work contingencies above and beyond the normal estimated costs if the conditions were not known and planned for in advance.

- On platform jackets with skirt piles, the annulus between the pile and skirt are sometime grouted. In preparation for severing the piles, there have been occasions where undocumented cement plugs have been found inside the pile. This prevents the placement of jetting or cutting tools inside the

pile. The soil around the pile would need to be jetted or excavated down to the severing depth for placement of external severing equipment.

- The discovery of mudplugs within piles in locations or blocks where other decommissioned platforms infrequently have mudplugs would require the mudplugs to be jetted out for placement of the severing tool. Operators may not want to incur the cost to send a crew out in advance to sound the piles for these plugs, so the cost estimate should include a work contingency.
- In pipeline abandonment, the pipelines are cleaned of hydrocarbons. The preferred method is flushing with sea water 2 ½ times the volume or until a sheen test does not show any hydrocarbons. Pipeline operators request waivers to use this method and request estimates using this method. If operators must use pigging methods there may be the risk of interference from paraffin, sand in the line, unknown pipe damage that may hinder pigging, or unknown valve conditions or flow direction.
- Well abandonment is often performed without the latest well information and sometimes even the latest information is not correct. Extra work not planned could be due to stuck valves, collapsed casing, or dropped objects in the wellbore needing coil tubing or a drilling rig to resolve.
- Subsea well abandonment exposes the decommissioning process to additional risk due to the complex nature of subsea operations. The amount of any work contingency included would depend on perceived accuracy of the information.

### 9.3. Uncertainties

Because of their low frequency of occurrence, the potential costs and the probability of uncertainties is much harder to predict. Delays and costs for some uncertainties can be estimated, but because of the low probability of occurrence, the costs are not normally included in a decommissioning estimate.

The following are examples of uncertainties that may arise during a decommissioning project and impact the project cost and schedule.

- Delays caused by Injury or death can be caused by personnel or equipment. This can cause delays of several days or longer depending on the investigation and any regulatory, law enforcement, or legal issues.
- Work stoppage caused by platform damage by marine vessels. For example, platforms have been damaged by tankers blown off course during storms. This causes additional delays and costs due to investigations, additional engineering planning, and repairs so that decommissioning can safely proceed.
- Delays and costs for standby due to labor force or equipment not arriving on time. This is usually a day or less, but can be longer.
- Damage to specialized equipment
- Service providers failing to complete contracted work or going out of business. New providers would need to be vetted, contracts signed, and schedules revised.
- Labor unrest or shortage. For example, a labor strike disrupted offshore operations in Norway in June 2015.
- Piracy events on a platform or against a vessel will cause cessation of operations pending government response.

- Blockage of work by environmental organizations
- Loss of key personnel due to personal emergencies, requiring either replacement personnel or rescheduling part the work
- Equipment malfunction or breakdown, requiring assessment to determine cause, repairing the equipment or mobilizing replacement equipment (if available). If replaced, the productivity of the replacement equipment may differ from the original.
- Disruption to onshore labor force, equipment, suppliers, or materials due to violence, riots, severe weather, or other causes
- Extreme events can occur, such as the severe civil unrest seen during the Arab Spring in Egypt in January and February 2011.



## 10. Non-technical Impacts on Decommissioning Costs

### 10.1. Introduction

This section discusses other considerations that affect decommissioning costs and that incorporate the professional judgment, industry experience, and institutional knowledge that shape decommissioning decisions. These considerations are less about hard data, which has been included elsewhere, and more about recognizing the demand trends, regional differences, market conditions, and technological innovations that affect how decommissioning is performed and how those trends, differences, and innovations impact decommissioning costs.

### 10.2. Inflation Impacts

Historically, many of the individual decommissioning costs roughly track the U.S. Consumer Price Index (CPI). Figure 10-1 compares the increase in rates for commonly used decommissioning vessels to the increase in the CPI since 1996. Although the trends of most of the rates parallel the trend of the CPI curve, a few outliers are apparent. For example, the demand for lift boats increased dramatically in 2005 following tropical storm and hurricane damage in the Gulf of Mexico.

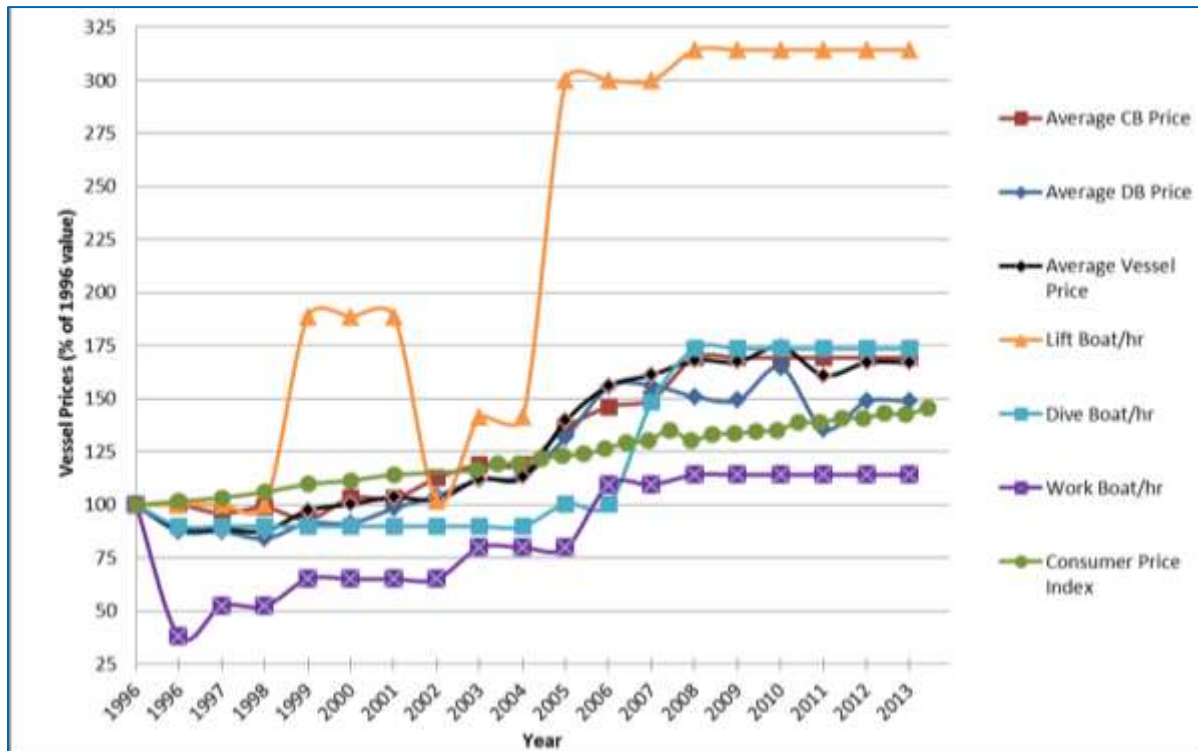

Figure 10-1. Offshore Vessel Prices Normalized to 1996

As shown in Figure 10-2, the Construction Price Index increased between 2003 and 2014 about 80% faster than the CPI. Figure 10-3 shows that the Heavy Construction Price Index increased during the same period at about double the rate of the CPI. The equipment and labor requirements for decommissioning are similar in nature to those used in heavy construction, so long term price trends would be expected to parallel the Construction and Heavy Construction price indices much more closely than consumer price trends. When estimating future decommissioning costs, the analysis should clearly state the year basis of the cost data the year for which costs are presented and account for inflation up to the time of decommissioning. For example, an estimate using 2015 cost data for a decommissioning project planned for 2020 would need to account for predicted inflation between 2015 and 2020.

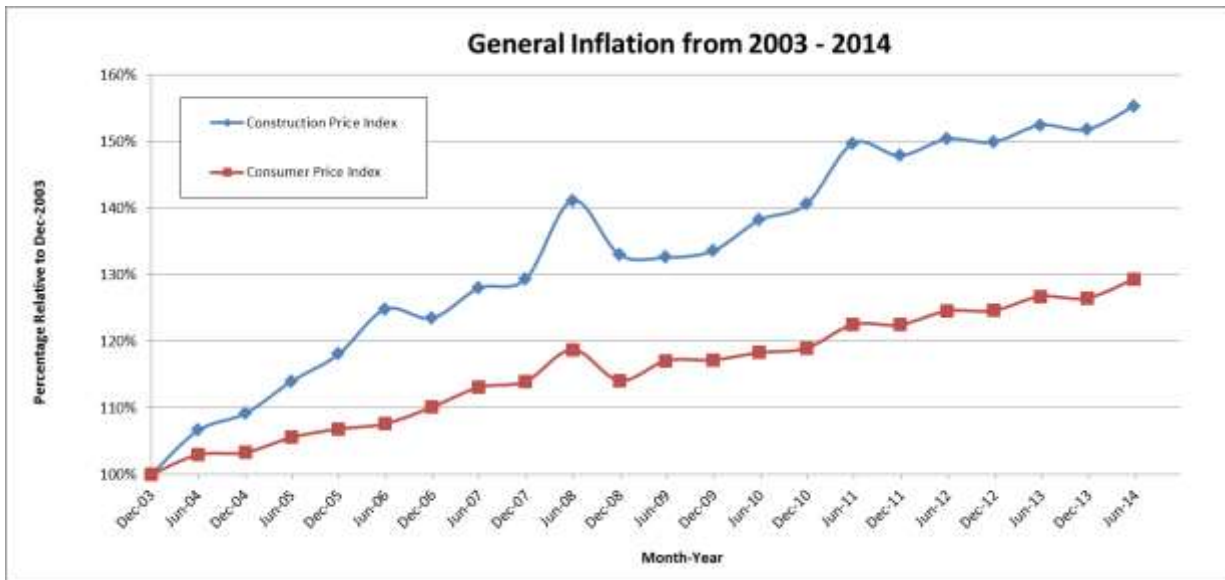

Figure 10-2. U.S. General Construction Inflation - Normalized to Dec-2003 Values

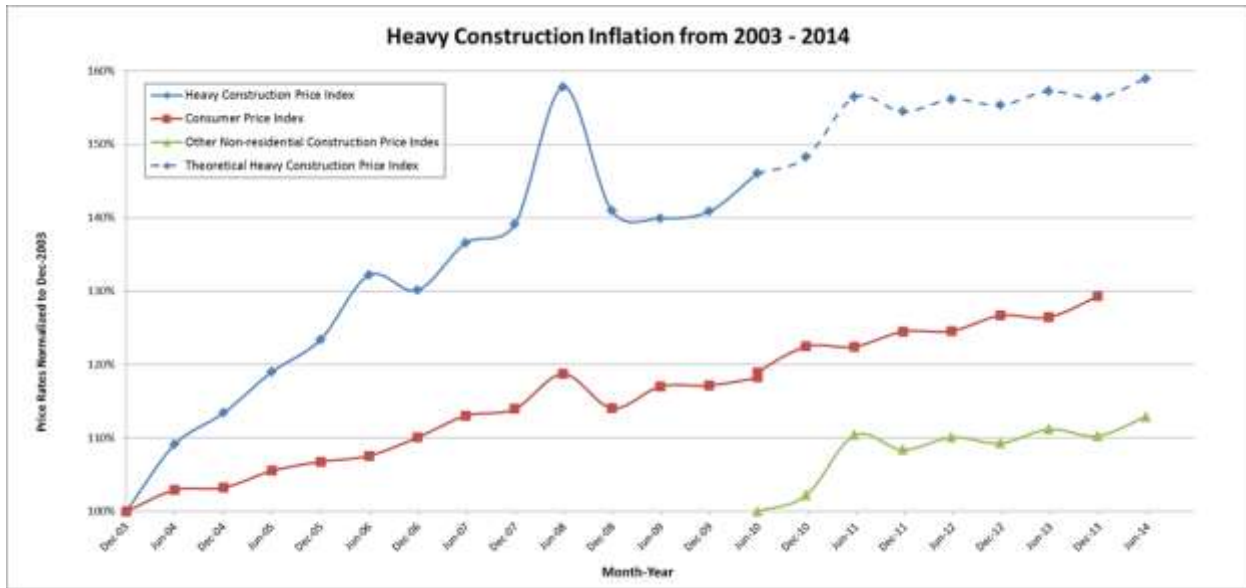

Figure 10-3. Heavy Construction Inflation from 2003 to 2014 - Normalized to Dec-2003

### 10.3. Demand Impacts

Decommissioning activity has been increasing in the Gulf of Mexico due to aging assets, declining production, and changes in federal regulations. The issuance of the “Idle Iron” Notice to Lessees (NTL No. 2010-G05) puts strict time limits on the decommissioning of idled offshore oil and gas assets in the Gulf of Mexico and is expected to accelerate the decommissioning of some structures. Sustained low oil and gas prices may further accelerate decommissioning activity as more facilities become uneconomical, although a decrease in oil prices may not be a dominant factor in determining when decommissioning occurs. Increased demand for decommissioning services may put upward pressure on decommissioning costs.

The international oil and gas industry is maturing and moving toward development of more robust offshore decommissioning regulations. Except in the North Sea, little decommissioning activity has occurred outside of U.S. waters. This will change as more countries adopt detailed regulations and offshore assets near end of life. Norway plans to issue risk based guidelines for well P&A in the second half of 2015. Thailand has issued proposed regulations and is signaling that operators will need to provide decommissioning plans and schedules in the near future. Increased demand for global decommissioning services in maturing offshore markets portends upward price pressures worldwide.

Local weather can impact demand as well. Hurricane and tropical storm damage to platforms in the Gulf of Mexico greatly increased the demand for decommissioning resources due to downed and damaged platforms. Figure 10-4 shows the increase in the number of platforms removed following the Hurricanes Katrina, Rita, and Ike.

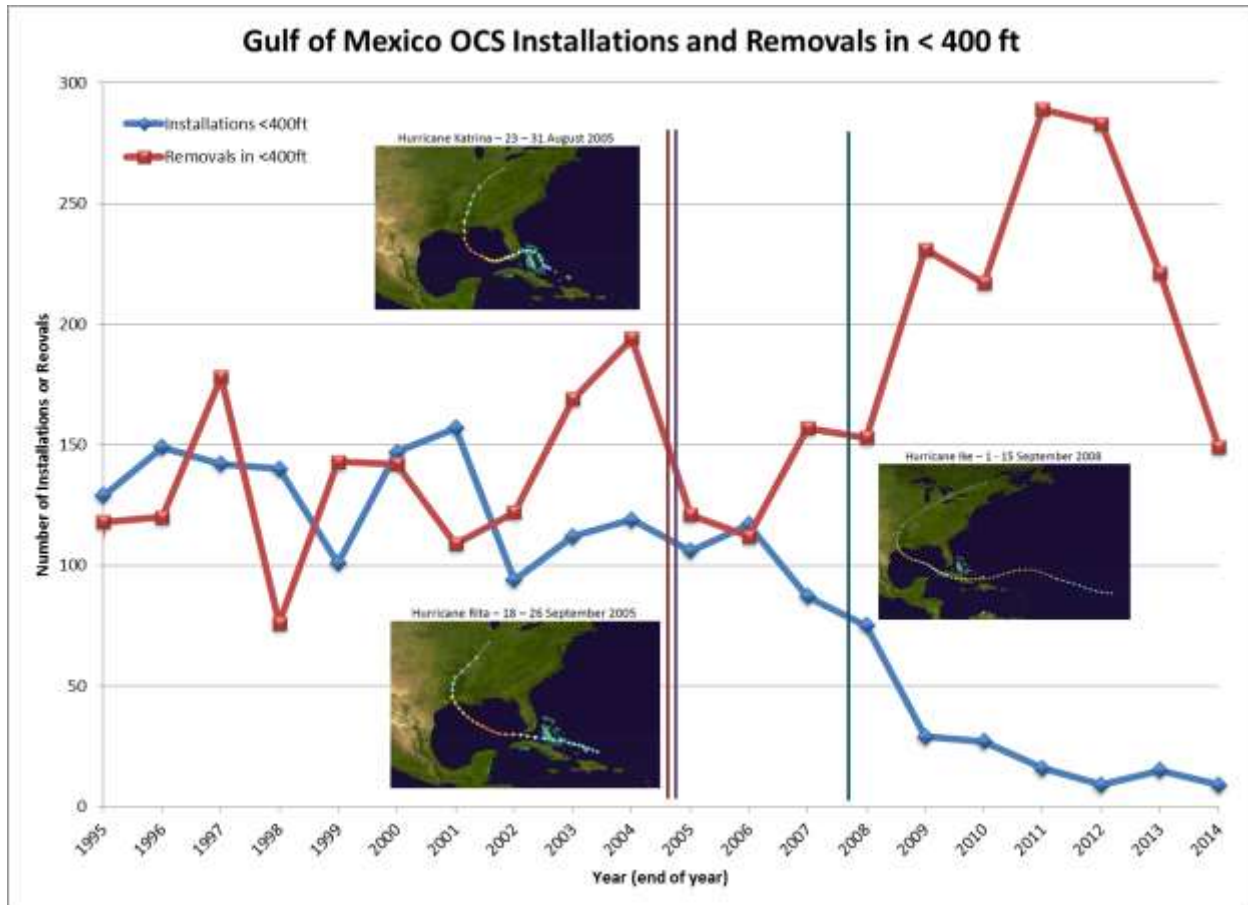

Figure 10-4. Platform Installations and Removals after Major Storms

## 10.4. Regional Impacts

Regional differences impact many aspects of offshore decommissioning, including the selection of the best decommissioning technique, the equipment used, and of course decommissioning costs.

### 10.4.1. Development

A region with a long history of offshore oil and gas development is more likely to have platforms which have exceeded their useful life and have already been decommissioned, leading to the development of companies and personnel with decommissioning experience. The reverse is also true, especially in global regions that do not have decommissioning regulations specifying when platforms are to be removed. As the decommissioning industry grows in a given region, procedural efficiencies and competition help to control costs. In contrast, a region that is just beginning to decommission production assets may face the need to import equipment and expertise, may need to develop support facilities, would need to develop and train a decommissioning labor force, and therefore would be likely to face higher initial decommissioning costs.

## 10.4.2. Resource Availability

The regional availability of vessels, equipment, and scrap facilities that support decommissioning operations also impacts the selection of decommissioning techniques and equipment and therefore impacts costs. In the 2014 BSEE report Decommissioning Cost Update for the Pacific OCS Region Facilities, the Mobilization & Demobilization of Derrick Barge costs account for 8% of the total costs. The available resources on the Pacific coast were limited to a DB500 without accommodation. That resource was used for dredging and had little experience in decommissioning. The other resources in the region were in use for marine construction, and the lack of decommissioning experience is a concern for planning operations. The 2014 Pacific report shows the Mob/Demob costs of derrick barges to range from \$3.1 MM to \$7.4 MM per platform based on 23 platforms analyzed (see Table 10-1). The long mobilization time (100 days) greatly increases the overall cost for the DB for a project that requires the derrick barge on location for 30 to 80 days. This cost is significant when compared to the Mob/Demob cost in the Gulf of Mexico of \$ 0.4 MM to \$ 1.3 MM based on 23 platforms (see Table 10-2).

Regions new to decommissioning operations need to mobilize equipment to the location. Depending on the distance from the location to the nearest region with assets to perform the work, the mobilization costs could become a significant portion of the total decommissioning costs. In remote areas or in areas where decommissioning is relatively new, bringing in decommissioning personnel from outside the area increases labor costs.

**Table 10-1. Estimated Derrick Barge Mob/Demob Costs, Pacific OCS**

<b>Project</b>	<b>DB Lift Capability</b>	<b>Mob/Demob Cost Calculation</b>	<b>Cost Per Platform</b>
Project I	500 ton	\$ 165,000 x 100 days x 90% / 2 platforms	\$7,425,000
Project II	2,000 ton	\$ 209,000 x 100 days x 90% / 4 platforms	\$4,702,500
Project III	2,000 ton	\$ 209,000 x 100 days x 90% / 5 platforms	\$3,762,000
Project IV	2,000 ton	\$ 209,000 x 100 days x 90% / 3 platforms	\$6,270,000
Project V	2,000 ton	\$209,000 x 100 days x 90% / 6 platforms	\$3,135,000
Project VI	2,000 ton	\$209,000 x 100 days x 90% / 3 platforms	\$6,270,000
Note: From BSEE report, "Decommissioning Cost Update for Pacific OCS Region Facilities", 2014.			

Table 10-2. Estimated Derrick Barge Mob/Demob Costs, GOM OCS

ICF Ref. #	Name	Piles	DB Size	Mob (USD)	Demob (USD)	Total (USD)
1	HI-156-A	3	300	\$263,020.16	\$263,020.16	<b>\$526,040.32</b>
2	EC-220	4	600/800	\$203,400.90	\$203,400.90	<b>\$406,801.80</b>
3	WD-97-A	4	600/800	\$277,299.70	\$277,299.70	<b>\$554,599.40</b>
4	HI-A538-A	4	2000	\$492,520.00	\$492,520.00	<b>\$985,040.00</b>
5	MP-223-A	4	2000	\$498,788.20	\$498,788.20	<b>\$997,576.40</b>
6	EC-353-A	4	2000	\$392,291.68	\$392,291.68	<b>\$784,583.36</b>
7	SP-49-C	4	4000	\$445,870.15	\$445,870.15	<b>\$891,740.30</b>
8	HI-A389-A	8	4000	\$653,539.13	\$653,539.13	<b>\$1,307,078.26</b>
9	EC-381-A	4	4000	\$389,225.10	\$389,225.10	<b>\$778,450.20</b>
10	MC-20-A	8	2000	\$622,513.79	\$622,513.79	<b>\$1,245,027.58</b>
11	EW-826-A	8	4000	\$327,624.55	\$327,624.55	<b>\$655,249.10</b>
12	WC-661-A	4	2000	\$453,096.60	\$453,096.60	<b>\$906,193.20</b>
13	SM-205-B	4	2000	\$622,513.79	\$622,513.79	<b>\$1,245,027.58</b>
14	MC-365-A	4	4000	\$359,425.45	\$359,425.45	<b>\$718,850.90</b>
15	GC-6-A	8	4000	\$247,450.45	\$247,450.45	<b>\$494,900.90</b>
16	GB-172-B	4	4000	\$274,611.30	\$274,611.30	<b>\$549,222.60</b>
17	EW-873-A	8	4000	\$314,671.30	\$314,671.30	<b>\$629,342.60</b>
18	EB-165-A	8	4000	\$517,975.80	\$517,975.80	<b>\$1,035,951.60</b>
19	EB-159-A	4	4000	\$598,095.80	\$598,095.80	<b>\$1,196,191.60</b>
20	EB-160-A	8	4000	\$517,975.80	\$517,975.80	<b>\$1,035,951.60</b>
21	MC-194-A	12	4000	\$449,272.90	\$449,272.90	<b>\$898,545.80</b>
22	MC-109-A	6	4000	\$400,600.00	\$400,600.00	<b>\$801,200.00</b>
23	GC-65-A	12	4000	\$286,228.70	\$286,228.70	<b>\$572,457.40</b>

### 10.4.3. Decommissioning Approach

Different countries follow different decommissioning approaches because of differences in the types of offshore structures, regulatory requirements, economics, or other regional factors. Table 10-3 presents a sample of decommissioning approaches outside of the Gulf of Mexico.

Table 10-3. Decommissioning Approaches around the World

Gulf of Thailand Platform Removal Technique Planning No decommissioning has occurred, only planning.	
Techniques	Description
Deck Removal	Some decks larger than in the GOM have been installed that were larger than the HLV capacity. A float-over technique was used, where the deck is carried on a submersible vessel. The vessel is specifically designed to fit around the jacket. It positions the deck over the jacket, ballasts down and installs the deck. Reverse installation will likely be the decommissioning technique.

<b>Alaska State Waters and Offshore Sakhalin Islands Platform Removal Technique Planning</b> No decommissioning has occurred, only planning.	
<b>Techniques</b>	<b>Description</b>
Jacket Removal	The jackets are heavy concrete gravity based structures. Planning has considered using massive diamond wire spreads to cut the jacket into sections for removal by a HLV.
<b>United Arab Emirates Platform Removal Technique Planning</b> No decommissioning has occurred, only planning.	
<b>Techniques</b>	<b>Description</b>
Complete Removal	Large gravity based hydrocarbon structures have been installed, resembling an upside down champagne glass with an open bottom. The hydrocarbons float on a water column inside the vessel. Planning considers pumping and cleaning the hydrocarbons from the vessel and then cutting the vessel into sections for removal. Information has been provided by BSEE that the UAE may consider leaving large structures in place. At the time of this study, this has not been confirmed.
<b>Trinidad Platform Removal Technique Planning</b> No decommissioning has occurred, only planning.	
<b>Techniques</b>	<b>Description</b>
Deck Decommissioning	Planning considers removing the deck and reefing both the deck and jacket.
<b>Some areas of South America and the Caspian Sea</b>	
<b>Techniques</b>	<b>Description</b>
Platform Decommissioning	Structures have been left to decay in place.
<b>Offshore Japan</b> <b>Platform Decommissioning Technique</b>	
<b>Techniques</b>	<b>Description</b>
Platform Decommissioning	Structures have been reefed offshore of Japan.

#### 10.4.4. Working Conditions

Regional differences in weather, sea states, and distances from shoreline facilities can also affect decommissioning costs. Harsh weather environments like the Cook Inlet Alaska or offshore Sakhalin Islands may reduce productivity or impose restrictions on the seasonal working window for decommissioning activities, both of which contribute to higher costs. Offshore facilities designed for regions with heavier seas may require more robust, heavier structures which are more costly to remove than structures designed for calmer or more sheltered locations.

### 10.5. Market Condition Impacts

Market conditions impact decommissioning costs in several ways. As mentioned above, sustained low oil and gas prices may render facilities uneconomical for continued operation, leading to them being

idled and decommissioned earlier. If such market conditions affect a large number of assets in a region, the demand and costs for decommissioning services will rise. However, short term decreases in oil prices would not be expected to be significant in determining decommissioning time.

Conversely, forecasts of higher oil and gas prices that lead to extended operating lives of existing production assets can also increase the demand for new offshore development. Increased development can cause competition for equipment with limited availability such as heavy lift vessels which are needed both for construction and decommissioning.

Some of the same vessels and equipment used for decommissioning are used by other sectors of oil and gas industry. An increase in oil and gas prices could lead to higher exploration and development activities, which could cause increased demand and supply constraints.

Federal regulations require that operators get approval from the BSEE District Manager before decommissioning wells and from the BSEE Regional Supervisor before decommissioning platforms, pipelines, or other facilities. Regulations also have a conservation component where BSEE makes a determination whether or not the oil company could continue to produce economically.

Disruptions, contraction, or excessive demand at ancillary facilities support industries could impact decommissioning costs. For example, a natural disaster or high steel scrap prices could overwhelm the recycling capabilities of regional scrap yards. This type of disruption could impact decommissioning costs positively or negatively.

## **10.6. Technology Impacts**

New technologies are constantly being developed to make offshore operations faster, cheaper, safer or even possible, as in the case of technologies for ever deeper water. New state-of-the-art technology is often initially costly, but ultimately new technologies tend to drive down costs or else they would not be accepted by the industry. One example is the conversion of jack-up drilling rigs to MOPU. They are less expensive than fixed or floating platforms, require less lead time, and can be decommissioned by jacking down and leaving the location.

In some cases, lack of suitable, cost effective technology drives decommissioning decisions. For example, the absence of any current technology to completely remove the large concrete gravity structures such as Condeep in the Norwegian sector of the North Sea within acceptable safety and technical risk criteria is a major reason that derogation of these structures is allowed. In addition, the costs of complete removal would be prohibitive.

Technological changes may have dramatic impacts on future decommissioning costs. Floating production systems and subsea systems eliminate much or all of the platform jacket structure and have radically different decommissioning requirements.



## 10.7. Regulatory Impacts

Regulations can either increase or decrease decommissioning costs. As noted above, regulations such as the “Idle Iron” NTL can increase decommissioning demand and costs while derogation of removal requirements for concrete structures in the UK and Norway in the North Sea can greatly reduce decommissioning costs. In some less-developed regions, idle steel jackets are simply abandoned in place. Regulations which require a higher degree of safety or stricter environmental compliance may impose higher direct costs on the decommissioning industry but greatly reduce the indirect costs associated with worker injuries and deaths and the costs associated with recovering from environmental lapses. Chapter 11 discusses regulatory differences in greater detail.

## 10.8. Other Possible Impacts

There are many other non-technical factors that can potentially impact decommissioning costs, but not all of them will be addressed in this study.

The following conditions may have an impact on decommissioning costs but are considered beyond the scope of the present study and will not be analyzed in the final report.

- Changing weather patterns or climate change leading to more storms, rising sea levels, or increased storm intensity
- Political trends such as armed conflict or nationalization of private assets in foreign countries
- Competition for resources such as from other offshore developments like wind farms
- Long term shifts in energy patterns such as a shift to a hydrogen economy, increased production of onshore natural gas from hydraulic fracturing, or reduced demand for fossil fuels due to widespread adoption of electric vehicles or increased renewable energy production
- New large onshore or offshore discoveries
- Government permission for access to more areas (ex. Pacific and Atlantic OCS.)
- Development of alternate forms of fossil energy such as gas hydrates, unconventional coal bed methane, or liquefied coal
- Increased demand for alternative uses for offshore facilities, e.g., adding wind turbines to facilities, or utilizing platforms and wells for CO<sub>2</sub> injection as part of a carbon capture and storage strategy
- Change in policies for artificial reef programs or reeving of semi-submersibles
- Change in federal regulations related to crude export
- Major natural disasters such as earthquakes (west coast) and hurricanes

# 11. Safety and Environmental Accidents, Incidents and Events

## 11.1. Introduction

ICF performed a search of industry reports and government databases to identify safety and environmental accidents, incidents, or events that occurred during facility decommissioning operations. ICF also reached out directly to government agencies to obtain additional relevant data. The main objective was to determine which decommissioning techniques are associated with the most frequent or the most serious types of accidents, injury, or event to develop a relative risk ranking.

Decommissioning incidents were not found to be classified separately from other offshore oil and gas related accidents, therefore this report also provides statistics for all offshore oil and gas activities. Decommissioning data is reported when it was identified and compared to overall offshore oil and gas statistics to identify any trends.

## 11.2. Data Sources

The primary data source for incidents in the United States was a data set provided by BSEE documenting decommissioning related events based on a keyword search of the Technical Information Management System (TIMS). The search yielded fewer than 350 individual records of identifiable decommissioning-related safety and environmental incidents over an eleven year period.

International organizations, such as the International Association of Oil & Gas Producers (IOGP) and the International Association of Drilling Contractors (IADC) also provided incident statistics. The primary sources for the international data in this report were the IOGP and the IADC datasets. Individual countries also track their incident statistics; however they showed the same trends as the worldwide statistics provided by the IOGP and the IADC and were omitted from the analysis to avoid repetition.

The International Regulators' Forum (IRF) comprises national regulatory agencies in 10 countries associated with health and safety in offshore upstream oil and gas activities. BSEE represents the IRF in the U.S. IRF member agencies in Australia, Brazil, Canada, Denmark, Mexico, the Netherlands, New Zealand, Norway, and the United Kingdom were contacted in order to identify additional data sources.. Responses were received from Australia, Brazil, Canada, Denmark, New Zealand, Norway, and United Kingdom but no additional data sources were identified. Overall, countries reported that they do not or are unable to track decommissioning specific incidents within their datasets. In addition, Canada - Newfoundland and Labrador Offshore Petroleum Board<sup>21</sup>, Denmark and New Zealand reported that they

---

<sup>21</sup> Canada has 2 IRF member agencies: Canada - Newfoundland and Labrador Offshore Petroleum Board and Canada - Nova Scotia Offshore Petroleum Board.

have not decommissioned any offshore oil and gas platforms and therefore do not have any decommissioning-specific data to include.

The IADC Incidents Statistics Program (ISP) tracks safety data from onshore and offshore drilling contractors and producers. Participation in the program is voluntary and all reported data is checked for quality assurance by IADC's Quality Assurance Department. As incentive to participate, the IADC provides recognition to rigs that achieve 365 days without a Lost-Time Incident. The company must be in good standing with the IADC and have submitted incident reports for all twelve months of the year. Data is collected from countries all over the world and is compiled by region. The IADC collects data on Recordable Incidents (fatalities, injuries, medical treatment, etc.) and Lost-Time Incidents.

The IOGP has industry's largest database of safety performance indicators from member company employees and contractors for onshore and offshore facilities. They collect data on fatalities, injuries, lost work days, restricted work days, and medical treatment cases. The IOGP also collects data on environmental performance indicators, with the database currently representing one third of known hydrocarbon production. The database reports gaseous emissions, energy consumption, flaring, aqueous and non-aqueous discharges, and oil and chemical spills. The participation in the program is voluntary. In 2012, environmental incident data was submitted by 62 member operating companies working 78 countries worldwide.

## 11.3. Safety Incidents and Events

### 11.3.1. U.S. Safety Incidents

Decommissioning-specific incidents and events were identified only for the United States from the BSEE TIMS data set. Table 11-1 lists the number of safety incidents from the BSEE data set with fatalities, injuries, injuries requiring evacuation, and injuries leading to lost time or restricted work/transfer by the type of equipment in use or the primary operation at the time of incident. Table 11-1 shows the number of incidents with fatalities, injuries, etc., but not the number of fatalities or injuries that resulted. A single incident may be flagged for multiple types of equipment and/or activities; i.e. an incident may be flagged for both plugging and abandonment and workover equipment or pipelines. Table 11-2 shows the number of safety incidents by incident type (fire, explosion, structural damage, etc.) and equipment type in use at the time of incident. Crane incidents were the most common type involving over half of all the incidents with reported incident types, followed by fire incidents. Most of the fire incidents often involved welding, cutting torches, overheating compressors, or kitchen equipment.

**Table 11-1. Number of U.S. Decommissioning Related Safety Incidents with Fatalities and Injuries by Equipment Type, 2004-2014<sup>22,23</sup>**

	Fatality	Injury – Required Evacuation	Injury – Minor Lost Time (1-3 days)	Injury – Major Lost Time (>3 days)	Injury– Major Restricted Work/ Transfer (>3 days)	Injury – Minor Restricted Work/ Transfer (1-3 days)	Other Injuries (<1 day lost/ restricted work/ job transfer)
Plugging and Abandonment <sup>24</sup>	8	123	8	32	20	31	35
Production Equipment	1	4	0	2	3	1	0
Drilling Equipment	0	2	0	1	1	0	0
Workover Equipment	0	1	1	0	0	1	0
Completion Equipment	0	0	0	0	0	0	0
Motor Vessel	0	2	0	1	0	2	0
Pipeline	0	2	0	1	0	0	0
Helicopter	0	0	0	0	0	0	0
Totals	9	134	9	37	24	35	35

Notes: Incidents may be reported in multiple categories so the totals may not equal the total number of incidents.

<sup>22</sup> BSEE Technical Information Management System (TIMS) Search, keywords Decom, PA, P&A, P & A, TA, T&A, T & A, remov, aband, plug. Compiled February 25, 2015.

<sup>23</sup> A single incident can result in fatalities and multiple levels of injuries so summing the number of incidents in a row would not accurately reflect the total number of incidents.

<sup>24</sup> These incidents were specifically flagged under P&A for the operation at the time of incident. Other incidents listed in the table are also related to decommissioning activities, but were flagged as such in the description of the incident, not in the equipment/operation type.

**Table 11-2. Number of U.S. Decommissioning Related Safety Incidents by Incident Type and Equipment Type, 2004-2014<sup>25,26</sup>**

	Fire	Explosion	Blowout	Lost Well Control, Surface	Lost Well Control, Underground	Lost Well Control, Diverter	Lost Well Control, Eqmt Failure	Collision	Structural Damage	Crane	Totals
Plugging and Abandonment <sup>27</sup>	35	3	1	0	1	0	2	1	7	58	108
Production Equipment	3	1	1	0	0	0	1	0	0	0	6
Drilling Equipment	0	0	0	0	0	0	0	0	0	0	0
Workover Equipment	1	0	0	0	0	0	0	0	0	5	6
Completion Equipment	0	0	0	0	0	0	0	0	0	0	0
Motor Vessel	2	0	0	0	0	0	0	1	0	0	3
Pipeline	1	0	0	0	0	0	0	0	1	0	2
Helicopter	0	0	0	0	0	0	0	0	0	0	0
Totals	42	4	2	0	1	0	3	2	8	63	125
Notes: Incidents may be reported in multiple categories so the totals may not equal the total number of incidents.											

<sup>25</sup> BSEE Technical Information Management System (TIMS) Search, keywords Decom, PA, P&A, P & A, TA, T&A, T & A, remov, aband, plug. Compiled February 25, 2015.

<sup>26</sup> A single incident may involve multiple types of equipment so the column totals may exceed the total number of incidents.

<sup>27</sup> These incidents were specifically flagged under P&A for the operation at the time of incident. Other incidents listed in the table are also related to decommissioning activities, but were flagged as such in the description of the incident, not in the equipment/operation type.

Table 11-3 shows the number of safety incidents with fatalities and injuries by incident cause. Human error yielded the highest number of incidents, followed by slips, trips, and falls and equipment failure. Table 11-4 shows the number of safety incidents by incident type and by incident cause. For incidents where both incident type and incident cause were reported, fires caused by equipment failure or human error constitute 45% of all incidents.

**Table 11-3. Number of U.S. Decommissioning Related Safety Incidents with Fatalities and Injuries by Cause, 2004-2014<sup>28,29</sup>**

	Fatality	Injury – Required Evacuation	Injury – Minor Lost Time (1-3 days)	Injury – Major Lost Time (>3 days)	Injury – Major Restricted Work/ Transfer (>3 days)	Injury – Minor Restricted Work/ Transfer (1-3 days)	Other Injuries (>1 day lost/ restricted work/ job transfer))
Equipment Failure	1	4	0	1	0	2	2
Human Error	2	21	0	11	5	6	4
Slip, Trip, Fall	0	4	1	1	1	2	1
Weather	0	5	0	2	0	1	2
External Damage	0	0	0	0	0	0	0
Leak	0	1	0	0	0	0	1
Upset H <sub>2</sub> O System	0	0	0	0	0	0	0
Overboard Fluid	0	0	0	0	0	0	0
Other <sup>30</sup>	1	1	0	1	0	0	0
Totals	4	36	1	16	6	11	10

Notes: Incidents may be reported in multiple categories so the totals may not equal the total number of incidents.

<sup>28</sup> BSEE Technical Information Management System (TIMS) Search, keywords Decom, PA, P&A, P & A, TA, T&A, T & A, remov, aband, plug. Compiled February 25, 2015.

<sup>29</sup> A single incident can result in fatalities and multiple levels of injuries so summing the number of incidents in a row would not accurately reflect the total number of incidents.

<sup>30</sup> "Other" includes causes such as mechanical delay of controls, falling object, unsecured equipment, and unknown causes.

**Table 11-4. Number of U.S. Decommissioning Related Safety Incidents by Cause, 2004-2014<sup>31</sup>**

	Fire	Explosion	Blowout	Lost Well Control, Surface	Lost Well Control, Underground	Lost Well Control, Diverter	Lost Well Control, Eqmt Failure	Collision	Structural damage	Crane	Totals
Equipment Failure	5	0	0	0	0	0	2	0	0	10	17
Human Error	7	1	1	0	0	0	1	0	3	10	23
Slip, Trip, Fall	0	0	0	0	0	0	0	0	0	0	0
Weather	0	0	0	0	0	0	1	0	0	1	2
External Damage	0	0	0	0	0	0	0	0	0	0	0
Leak	1	0	0	0	0	0	0	0	0	0	1
Upset H <sub>2</sub> O System	0	0	0	0	0	0	0	0	0	0	0
Overboard Fluid	0	0	0	0	0	0	0	0	0	0	0
Other <sup>32</sup>	1	0	1	0	0	0	1	1	1	0	5
<b>Totals</b>	<b>14</b>	<b>1</b>	<b>2</b>	<b>0</b>	<b>0</b>	<b>0</b>	<b>5</b>	<b>1</b>	<b>4</b>	<b>21</b>	<b>48</b>

Notes: Incidents may be reported in multiple categories so the totals may not equal the total number of incidents.

<sup>31</sup> BSEE Technical Information Management System (TIMS) Search, keywords Decom, PA, P&A, P & A, TA, T&A, T & A, remov, aband, plug. Compiled February 25, 2015.

<sup>32</sup> "Other" includes causes such as mechanical delay of controls, falling object, unsecured equipment, and unknown causes.

Figure 4-1 illustrates the “severity value” of the injury/fatality incidents by operation and equipment type. A severity value for each component of an accident (i.e., injury/fatality level, amount of spillage, type of event, and property damage amount) is assigned a value, ranging from 0 to 640, based on the extent of the damage or injuries resulting from it. These geometrically increasing values, e.g. 0, 40, 80, were determined by industry expert opinion, values of previous accidents, and OSHA injury definitions. The component severity values are summed to produce the incident severity value.<sup>33</sup>

Drilling Equipment was associated with the highest injury severity, but Other equipment was associated with the highest severity for fatalities. Figure 11-2 shows the severity of the injury/fatality incidents by incident cause. Incidents caused by Human Error and Equipment Failure had the highest severity.

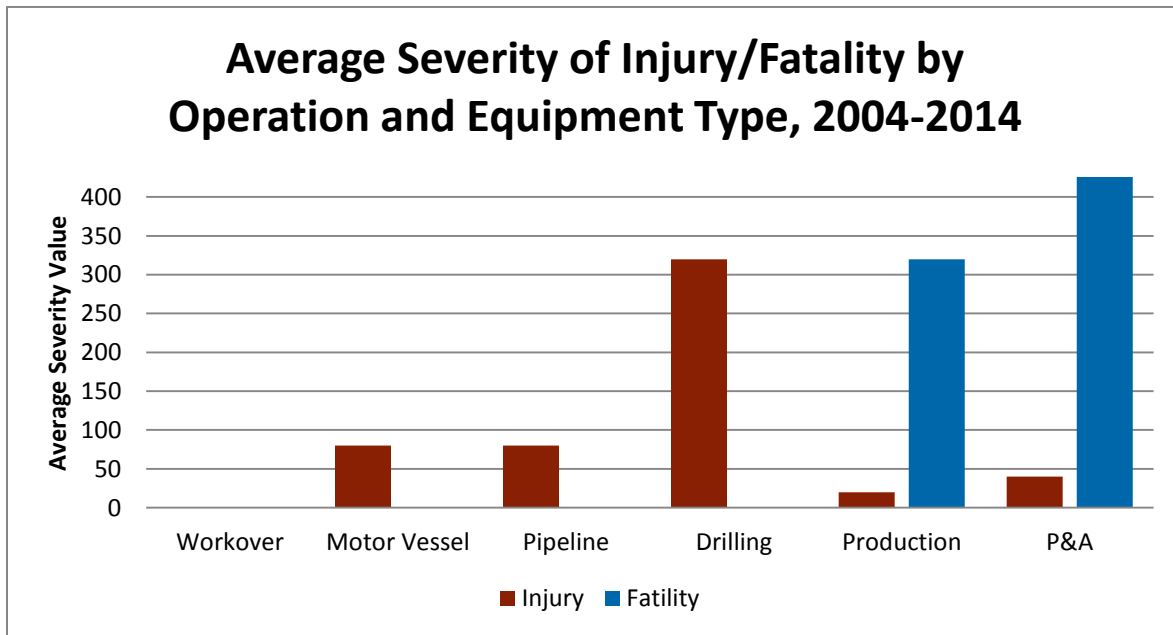

**Figure 11-1. Average Severity of U.S. Decommissioning Related Injury/Fatality by Operation and Equipment Type, 2004-2014<sup>34</sup>**

<sup>33</sup> Industrial Economics, Incorporated, “Compliance Indexing Project”, 2010.

<sup>34</sup> BSEE Technical Information Management System (TIMS) Search, keywords Decom, PA, P&A, P & A, TA, T&A, T & A, remov, aband, plug. Compiled February 25, 2015.



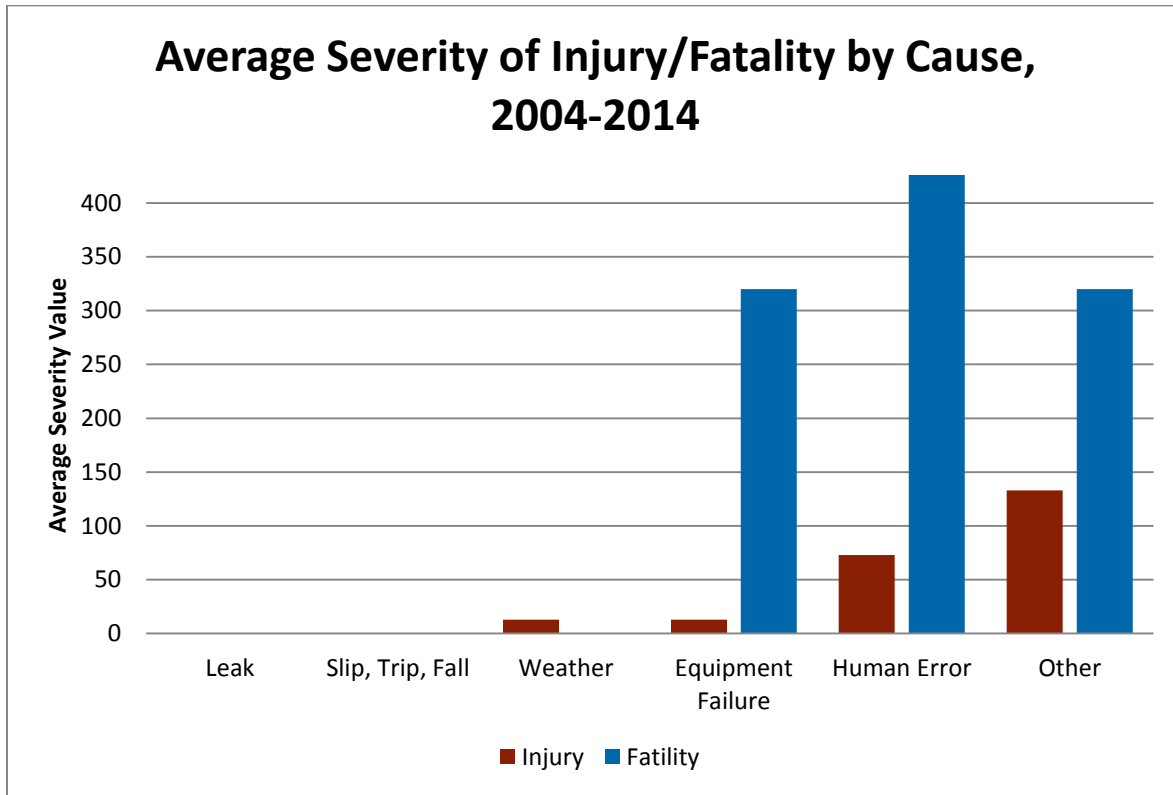

Figure 11-2. Average Severity of U.S. Decommissioning Related Injury/Fatality by Cause, 2004-2014<sup>35</sup>

### 11.3.2. Global Safety Incidents

Table 11-5 provides a worldwide look at the number of offshore safety incidents between 2010 and 2013, as reported to the IADC. This data represents offshore incidents by members of the IADC, including drilling contractors and producers. This data set is not limited to decommissioning operations, but incident trends correlate to trends identified in the decommissioning specific data that was available for the United States. The data breaks down the incidents by specific operation, including making connections, running casings, routine drilling operations, jacking up/down operations, transportation, etc. Although not decommissioning specific, the table provides a detailed look into the types of activities that see the highest numbers of safety incidents. Nearly all of the activities listed are performed during decommissioning. Activities most common during decommissioning include cementing, material handling, walking, travel and transportation, jacking up and down, and rigging up and down. Although results vary by country, overall rig and equipment repairs and maintenance showed the highest rate of safety incidents (not including the Other category), accounting for 15.4% of all incidents.

<sup>35</sup> BSEE Technical Information Management System (TIMS) Search, keywords Decom, PA, P&A, P & A, TA, T&A, T & A, remov, aband, plug. Compiled February 25, 2015.

Table 11-5. Worldwide Reportable Incidents by Operation, 2010-2013<sup>36</sup>

		US	Canada	Central America & Caribbean	Europe	Africa	Middle East	Asia Pacific & Australia	South America	Total
<b>Tripping in/out (makeup/brakeout BHA, test tools, etc.)</b>	Count	77	4	7	33	16	41	48	21	<b>247</b>
	Percent	12.6 %	30.8 %	8.6 %	6.1 %	3.7 %	12.7 %	9.6 %	6.2 %	<b>8.7 %</b>
<b>Making Connection</b>	Count	10	0	1	11	3	7	12	9	<b>53</b>
	Percent	1.6 %	0.0 %	1.2 %	2.0 %	0.7 %	2.2 %	2.4 %	2.7 %	<b>1.9 %</b>
<b>Routine Drilling Operations</b>	Count	32	0	9	50	42	14	57	29	<b>233</b>
	Percent	5.2 %	0.0 %	11.1 %	9.2 %	9.7 %	4.3 %	11.4 %	8.5 %	<b>1.9 %</b>
<b>Running Casing/Tubing (rig up/down csg. tools)</b>	Count	19	0	3	27	26	17	22	12	<b>126</b>
	Percent	3.1 %	0.0 %	3.7 %	5.0 %	6.0 %	5.3 %	4.4 %	3.5 %	<b>4.4 %</b>
<b>Laying Down/Picking up Pipe/Tubulars</b>	Count	46	1	4	26	14	24	24	16	<b>155</b>
	Percent	7.5 %	7.7 %	4.9 %	4.8 %	3.3 %	7.4 %	4.8 %	4.7 %	<b>5.4 %</b>
<b>Material Handling Manual</b>	Count	60	1	4	53	39	31	38	31	<b>257</b>
	Percent	9.8 %	7.7 %	4.9 %	9.7 %	9.1 %	9.6 %	7.6 %	9.1 %	<b>9.0 %</b>
<b>Material Handling Crane/ Cherry Picker /Forklift</b>	Count	53	0	11	31	31	22	42	41	<b>231</b>
	Percent	8.7 %	0.0 %	13.6 %	5.7 %	7.2 %	6.8 %	8.4 %	12.1 %	<b>8.1 %</b>
<b>Rigging Up/Down (rig move preparation, rig move)</b>	Count	28	0	3	9	13	11	17	5	<b>86</b>
	Percent	4.6 %	0.0 %	3.7 %	1.7 %	3.0 %	3.4 %	3.4 %	1.5 %	<b>3.0 %</b>
<b>Well Control (BOP)</b>	Count	27	0	2	10	12	25	14	11	<b>101</b>

<sup>36</sup> International Association of Drilling Contractors (IADC) Incidents Statistics Program (ISP), 2010-2012.

		US	Canada	Central America & Caribbean	Europe	Africa	Middle East	Asia Pacific & Australia	South America	Total
<b>Stack (well head/ tree) Install/ Maintenance</b>	Percent	4.4 %	0.0 %	2.5 %	1.8 %	2.8 %	7.7 %	2.8 %	3.2 %	<b>3.6 %</b>
<b>Rig/ Equipment Repairs or Maintenance</b>	Count	65	0	15	92	83	46	73	64	<b>438</b>
	Percent	10.6 %	0.0 %	18.5 %	16.9 %	19.3 %	14.2 %	14.5 %	18.8 %	<b>15.4 %</b>
<b>Mud Mixing/ Pumping</b>	Count	11	2	0	13	5	8	7	4	<b>50</b>
	Percent	1.8 %	15.4 %	0.0 %	2.4 %	1.2 %	2.5 %	1.4 %	1.2 %	<b>1.8 %</b>
<b>Cementing</b>	Count	4	0	1	3	4	2	8	4	<b>26</b>
	Percent	0.7 %	0.0 %	1.2 %	0.6 %	0.9 %	0.6 %	1.6 %	1.2 %	<b>0.9 %</b>
<b>Special Operations (wireline, perforating, etc.)</b>	Count	13	0	1	9	6	3	4	2	<b>38</b>
	Percent	2.1 %	0.0 %	1.2 %	1.7 %	1.4 %	0.9 %	0.8 %	0.6 %	<b>1.3 %</b>
<b>Walking</b>	Count	38	1	2	58	25	20	22	22	<b>188</b>
	Percent	6.2 %	7.7 %	2.5 %	10.6 %	5.8 %	6.2 %	4.4 %	6.5 %	<b>6.6 %</b>
<b>Training</b>	Count	2	0	0	1	2	0	2	1	<b>8</b>
	Percent	0.3 %	0.0 %	0.0 %	0.2 %	0.5 %	0.0 %	0.4 %	0.3 %	<b>0.3 %</b>
<b>Well Testing</b>	Count	0	0	1	0	0	3	2	2	<b>8</b>
	Percent	0.0 %	0.0 %	1.2 %	0.0 %	0.0 %	0.9 %	0.4 %	0.6 %	<b>0.3 %</b>
<b>Abrasive Blasting/Paint/Scale Removal</b>	Count	3	0	1	1	1	0	1	0	<b>7</b>
	Percent	0.5 %	0.0 %	1.2 %	0.2 %	0.2 %	0.0 %	0.2 %	0.0 %	<b>0.3 %</b>
<b>Painting (painting related tasks)</b>	Count	1	0	0	2	0	4	1	1	<b>9</b>
	Percent	0.2 %	0.0 %	0.0 %	0.4 %	0.0 %	1.2 %	0.2 %	0.30 %	<b>0.3 %</b>
<b>Running/Retrieving</b>	Count	0	0	0	3	0	0	4	2	<b>9</b>

		US	Canada	Central America & Caribbean	Europe	Africa	Middle East	Asia Pacific & Australia	South America	Total
<b>Anchors</b>	Percent	0.0 %	0.0 %	0.0 %	0.6 %	0.0 %	0.0 %	0.8 %	0.6 %	<b>0.3 %</b>
<b>Handling Riser</b>	Count	7	0	0	5	9	2	9	9	<b>41</b>
	Percent	1.2 %	0.0 %	0.0 %	0.9 %	2.1 %	0.6 %	1.8 %	2.7 %	<b>1.4 %</b>
<b>Jacking Up/Down Operations</b>	Count	4	0	0	0	1	1	3	0	<b>9</b>
	Percent	0.7 %	0.0 %	0.0 %	0.0 %	0.2 %	0.3 %	0.6 %	0.0 %	<b>0.3 %</b>
<b>Travel/ Transportation</b>	Count	12	1	0	7	5	2	3	6	<b>36</b>
	Percent	2.0 %	7.7 %	0.00 %	1.3 %	1.2 %	0.6 %	0.6 %	1.8 %	<b>1.3 %</b>
<b>Other</b>	Count	99	3	16	101	94	41	89	48	<b>491</b>
	Percent	16.2 %	23.1 %	19.8 %	18.5 %	21.8 %	12.7 %	17.7 %	14.1 %	<b>17.3 %</b>

Figure 11-3 and Figure 11-4 present data on fatalities and Lost Work Day Cases (LWDCs) by operation and by category. Due to data availability restrictions, fatalities presented in both figures represent fatalities from onshore and offshore operations. LWDCs are for offshore operations only. As with the previous table, this data set does not represent decommissioning specific incidents, but incidents that occur over the course of the offshore installation lifetime. Construction, commissioning, and decommissioning activities - which include construction, fabrication and installation of equipment, test activities to verify design specifications, disassembly, removal, and disposal - yielded 37 fatalities and 163 LWDCs over the three year period, accounting for approximately 9% of the incidents. Drilling, workover and well services had the highest number of instances making up approximately 21% of the incidents identified. Explosions and burns caused the highest number of fatalities, but “Struck by” and “Caught in/under/between” incidents accounted for the most overall fatality and LWDC incidents.

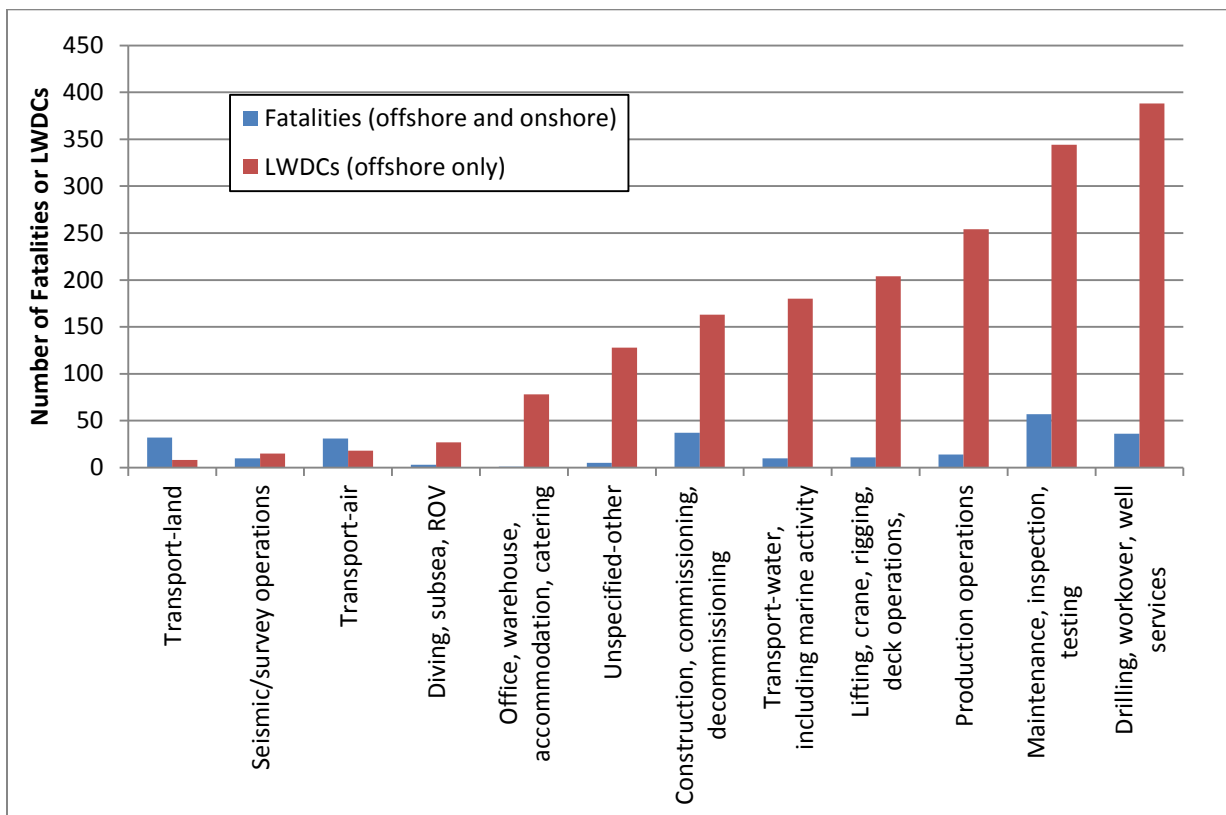

Figure 11-3. Worldwide Fatalities and Lost Work Day Cases (LWDCs) by Operation, 2010-2012<sup>37</sup>

<sup>37</sup> International Association of Oil & Gas Producers (IOGP). Safety Performance Indicators 2010-2012.

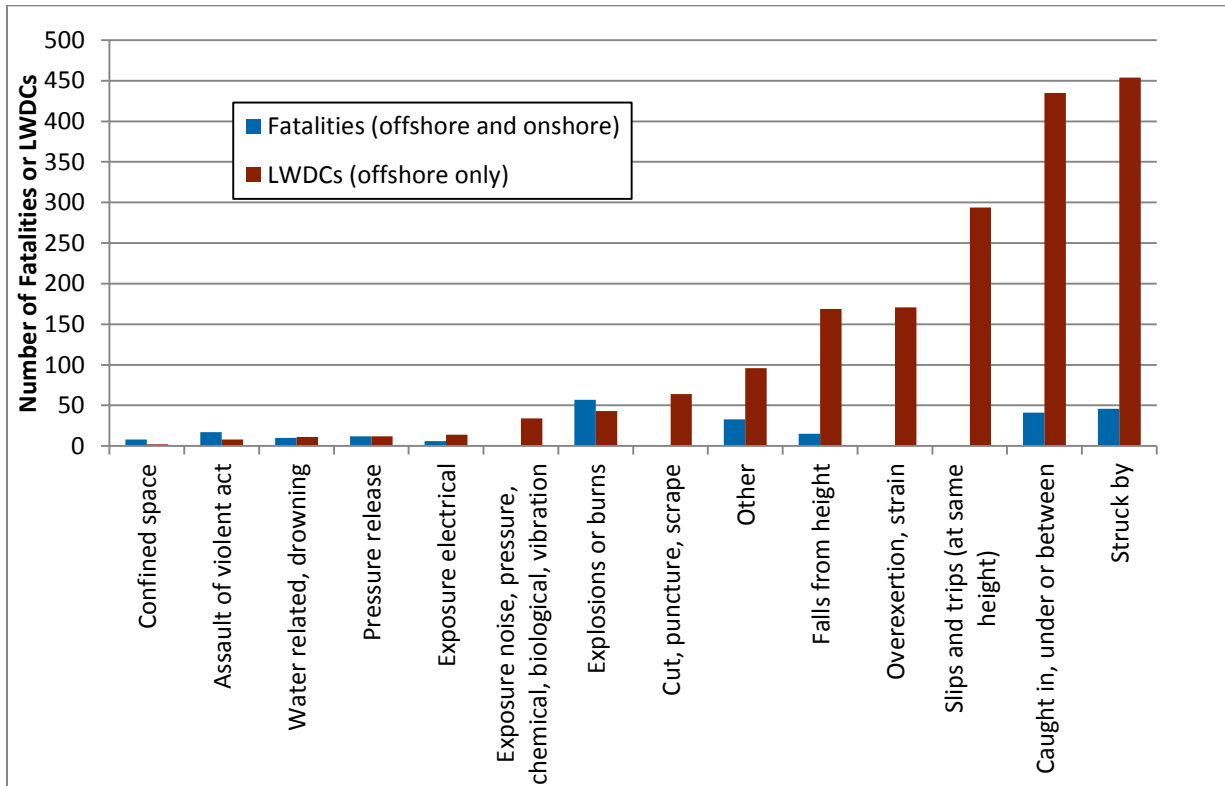

Figure 11-4. Worldwide Fatalities and LWDCs by Category, 2010-2012<sup>38</sup>

## 11.4. Environmental Incidents and Events

### 11.4.1. U.S. Environmental Incidents

As stated earlier, decommissioning specific incidents and events were identified only for the United States from the BSEE TIMS data set. Table 11-6 lists the number of spill incidents from the BSEE data set by operation at the time of incident. The spills are broken out by the type of material released. A single incident may be flagged for multiple types of equipment and/or activities; i.e. an incident may be flagged for both plugging and abandonment and workover equipment or pipelines. Oil and condensate were the leading spill materials for decommissioning incidents. Table 11-7 shows the number of spill incidents by cause of the incident. The leading causes were equipment failure, leaks from wells, and human error.

<sup>38</sup> International Association of Oil & Gas Producers (IOGP). Safety Performance Indicators 2010-2012.

**Table 11-6. Number of U.S. Spill Incidents by Equipment Type and Spill Material, 2004-2014<sup>39</sup>**

	Oil	Diesel	Condensate	Hydraulic	Natural Gas	Other <sup>40</sup>	Total
Plugging and Abandonment <sup>41</sup>	7	2	6	4	3	4	26
Production Equipment	2	0	1	0	0	1	4
Drilling Equipment	0	0	0	0	0	2	2
Workover Equipment	1	0	0	0	0	0	1
Completion Equipment	0	0	0	0	0	0	0
Motor Vessel	0	0	0	0	0	0	0
Pipeline	0	0	1	0	1	0	2
Helicopter	0	0	0	0	0	0	0
Totals	10	2	8	4	4	7	35

Notes: Incidents may be reported in multiple categories so the totals may not equal the total number of incidents.

**Table 11-7. Number of U.S. Spill Incidents by Cause, 2004-2014<sup>42</sup>**

	Oil	Diesel	Condensate	Hydraulic	Natural Gas	Other <sup>43</sup>	Total
Equipment Failure	1	0	1	2	1	3	8
Human Error	1	0	2	0	1	1	5
Slip, Trip, Fall	0	0	0	0	0	0	0
Weather	1	0	1	0	1	0	3
External Damage	0	0	1	0	1	1	3
Leak	3	1	1	0	1	1	7
Upset H <sub>2</sub> O System	0	0	0	0	0	0	0
Overboard Fluid	0	0	0	0	0	0	0
Other	2	0	3	0	0	1	6
Totals	8	1	9	2	5	7	32

Notes: Incidents may be reported in multiple categories so the totals may not equal the total number of incidents.

<sup>39</sup> BSEE Technical Information Management System (TIMS) Search, keywords Decom, PA, P&A, P & A, TA, T&A, T & A, remov, aband, plug. Compiled February 25, 2015.

<sup>40</sup> "Other" includes materials such as synthetic base mud, food grade hydraulic oil, water, and glycol.

<sup>41</sup> These incidents were specifically flagged under P&A for the operation at the time of incident. Other incidents listed in the table are also related to decommissioning activities, but were flagged as such in the description of the incident, not in the equipment/operation type.

<sup>42</sup> BSEE Technical Information Management System (TIMS) Search, keywords Decom, PA, P&A, P & A, TA, T&A, T & A, remov, aband, plug. Compiled February 25, 2015.

<sup>43</sup> "Other" includes materials such as synthetic base mud, food grade hydraulic oil, water, and glycol.

For decommissioning specific events in the United States, Figure 11-5 illustrates the average severity of spill incidents by operation and equipment type and Figure 11-6 shows the total spill volume by operation and equipment type. Drilling equipment related spills, most frequently associated with well abandonment (both temporary and permanent), caused the highest average spill severity and the greatest spill volumes.

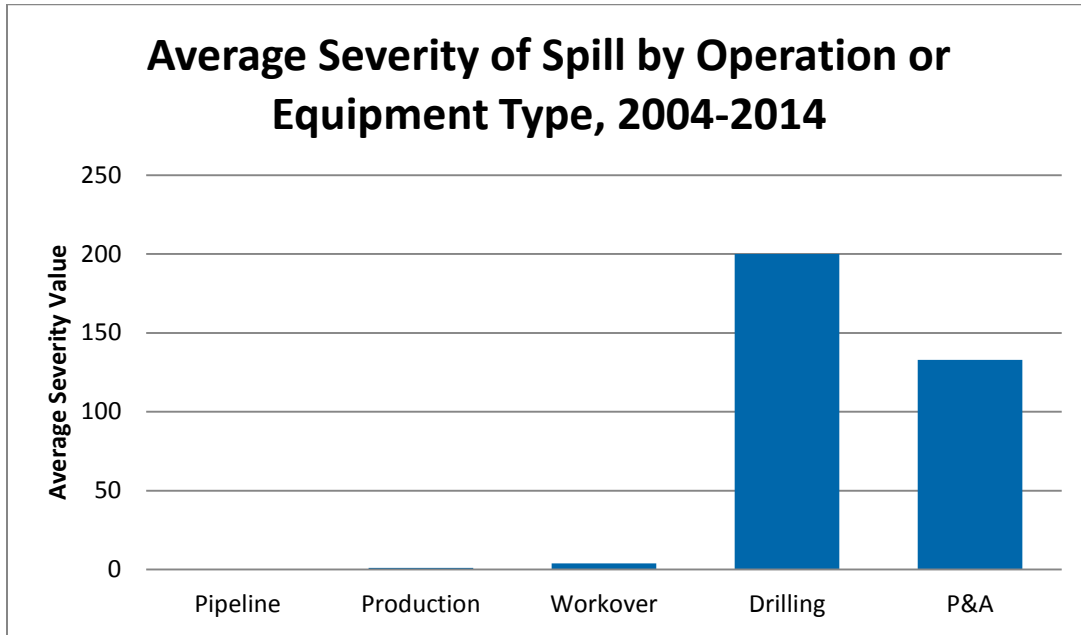
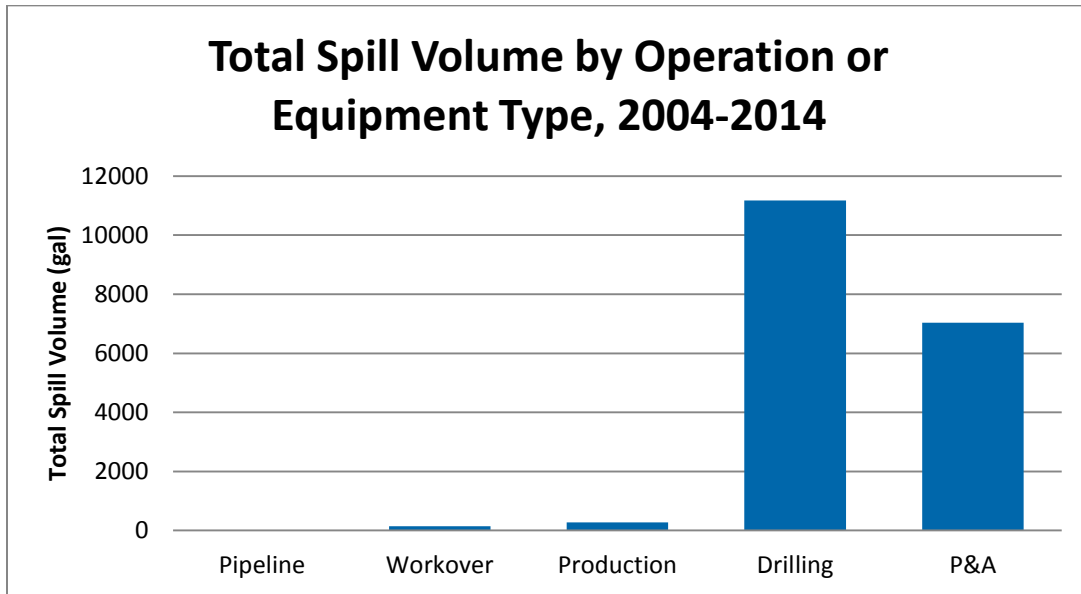

Figure 11-5. Average Severity of U.S. Spills by Operation or Equipment Type, 2004-2014<sup>44</sup>

<sup>44</sup> BSEE Technical Information Management System (TIMS) Search, keywords Decom, PA, P&A, P & A, TA, T&A, T & A, remov, aband, plug. Compiled February 25, 2015.





**Figure 11-6. Total Spill Volume of U.S. Spills by Operation or Equipment Type, 2004-2014<sup>45</sup>**

Figure 11-7 shows the average severity of spill incidents by cause for decommissioning specific events in the United States. Human error and equipment failure had overall the highest severity values. Leaks were on the lower end of severity value despite having the second highest number of incidents. Figure 11-8 shows that the greatest volume of spills was caused by human error and equipment failure.

<sup>45</sup> BSEE Technical Information Management System (TIMS) Search, keywords Decom, PA, P&A, P & A, TA, T&A, T & A, remov, aband, plug. Compiled February 25, 2015.

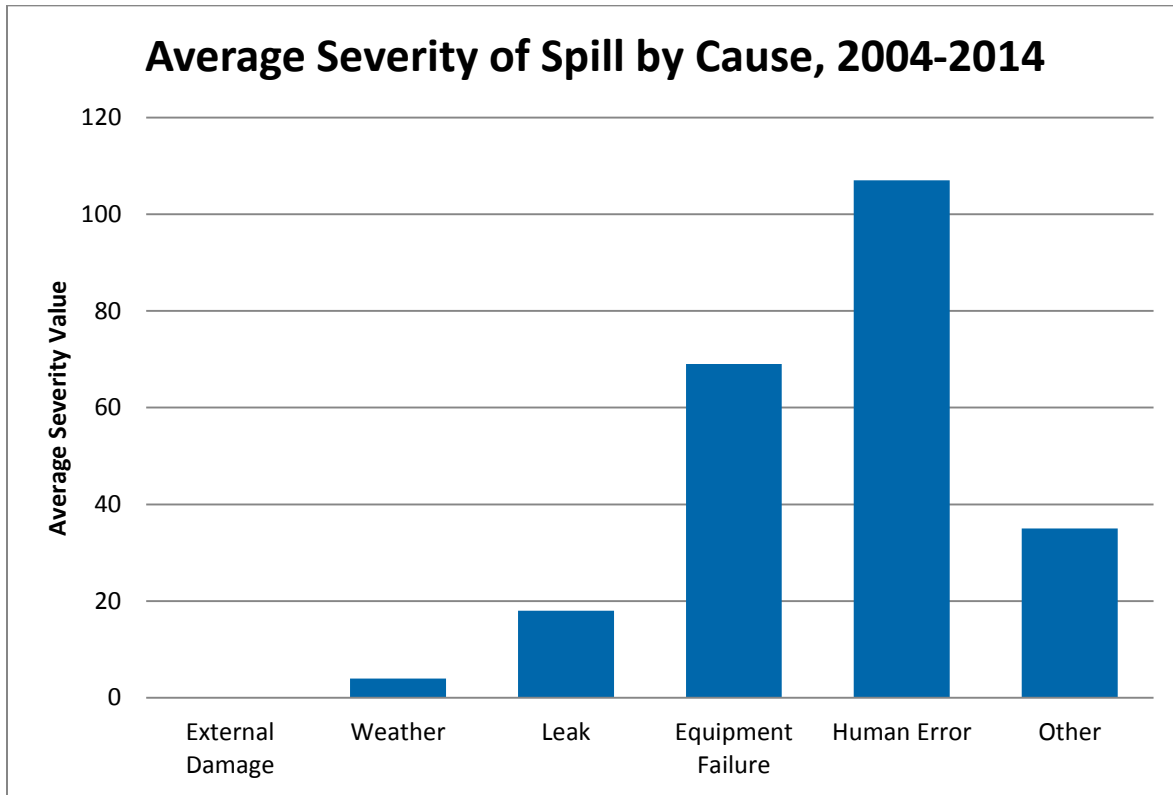

Figure 11-7. Average Severity of U.S. Decommissioning Spills by Cause, 2004-2014<sup>46</sup>

<sup>46</sup> BSEE Technical Information Management System (TIMS) Search, keywords Decom, PA, P&A, P & A, TA, T&A, T & A, remov, aband, plug. Compiled February 25, 2015.

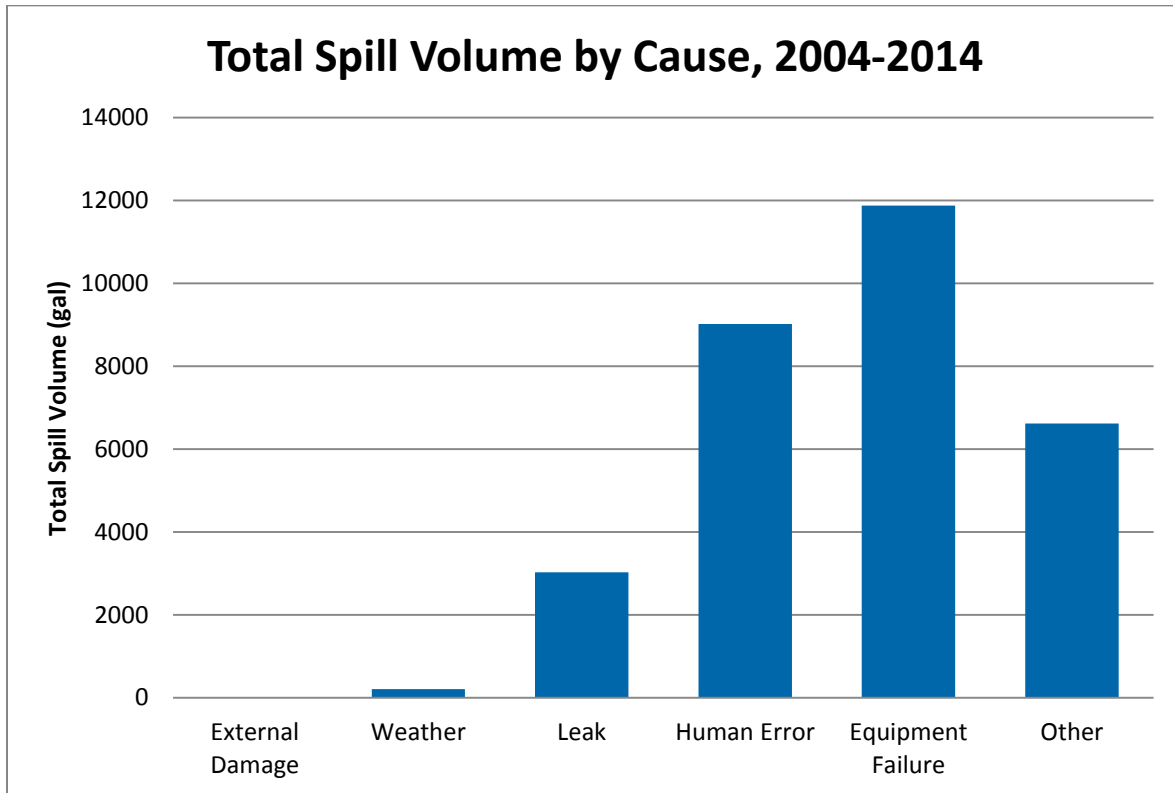

Figure 11-8. Total Spill Volume of U.S. Decommissioning Spills by Cause, 2004-2014<sup>47</sup>

### 11.4.2. Global Environmental Incidents

Figure 11-9 and Figure 11-10 represent worldwide data on spills over 100 barrels (bbls) in size and 10 to 100 barrels in size, respectively. They illustrate the number of spills and the volume lost from primary containment by cause of the incident. This data was filtered to include only spills that occurred on offshore installations, but does not represent decommissioning specific incidents exclusively. For larger spills (over 100 bbls), third party damage and equipment failure were the primary causes. For the volume lost, third party damage and operator or technical error were the leaders. For the smaller spills, corrosion and equipment failure were the leading causes.

<sup>47</sup> BSEE Technical Information Management System (TIMS) Search, keywords Decom, PA, P&A, P & A, TA, T&A, T & A, remov, aband, plug. Compiled February 25, 2015.

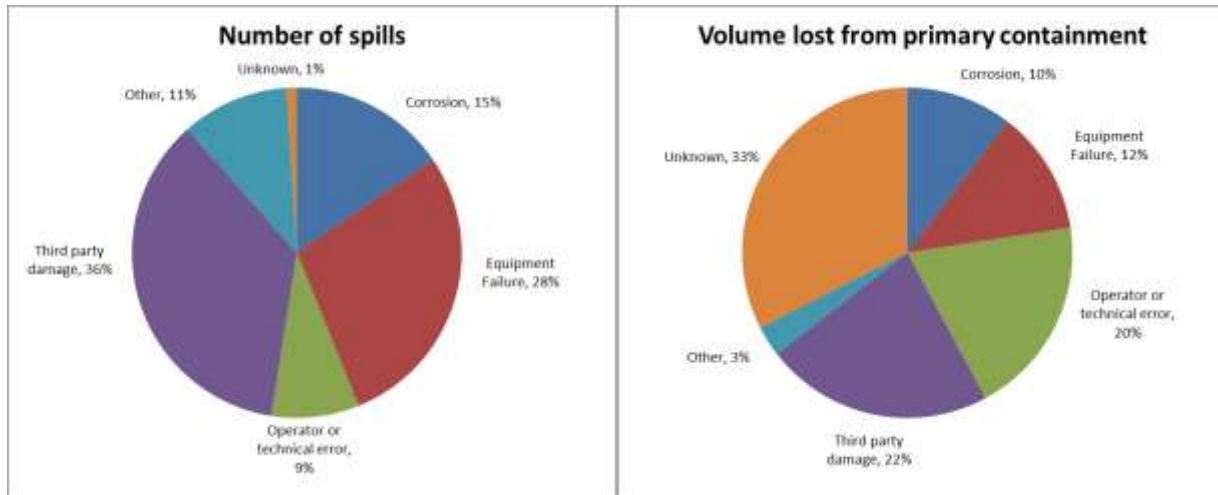

Figure 11-9. Worldwide Number of Spills >100 bbl in Size and Volume Lost from Primary Containment, 2010-2012<sup>48</sup>

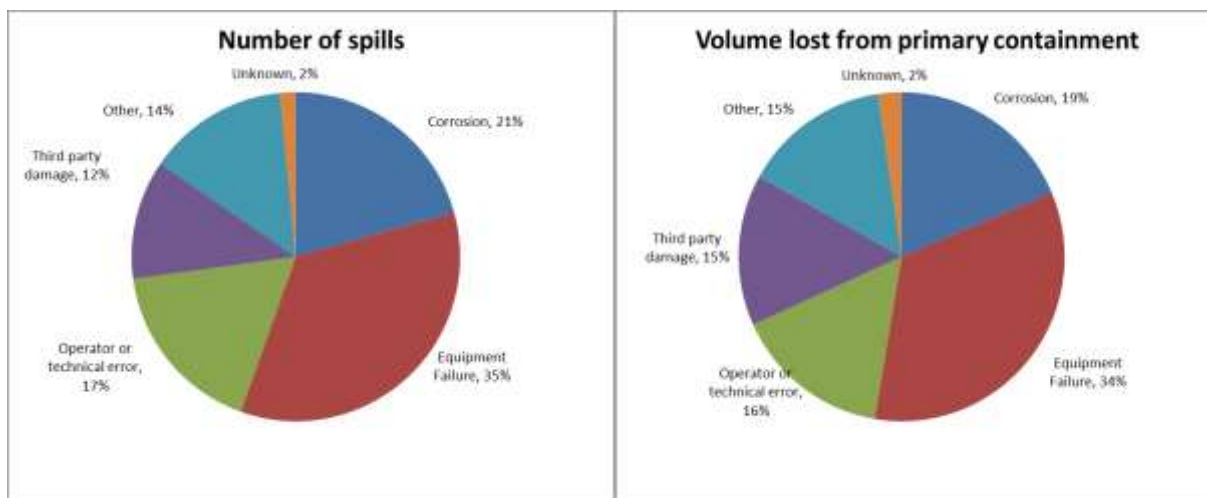

Figure 11-10. Worldwide Number of Spills 10-100 bbl in Size and Volume Lost from Primary Containment, 2010-2012

## 11.5. Risk Ranking

Cranes utilized in decommissioning activities contributed to the highest number of safety incidents. Fires caused by hot work or overheating equipment are also among the most frequent safety incidents during decommissioning activities. Other types of incidents such as transportation accidents, although less common, can lead to extremely severe injury and fatality incidents. The leading causes of safety incidents are equipment failure and human error, based on both number of incidents and the severity of the incidents.

<sup>48</sup> International Association of Oil & Gas Producers (IOGP). Environmental Performance Indicators 2010-2012

Environmental incidents are primarily caused by human error and equipment failure/corrosion. Human error, weather, and third party damage were noted to yield more severe spills. However, for smaller spills, equipment failure and corrosion were noted to be the most common causes. Although having fewer identified incidents, spills during decommissioning-related incidents involving drilling equipment caused the largest and most severe spills. The causes for these incidents were poor rig alignment, debris accumulation, and seal failure in equipment.

Although worldwide data was only available for incidents that occurred during all stages of an offshore installation lifetime, not just decommissioning, incident trends correlate to trends identified in the decommissioning specific data that was available for the United States.

## 12. Analysis of Decommissioning and Facility Removal Regulations

ICF researched and analyzed the offshore and facility decommissioning regulations of federal agencies, state agencies, and other worldwide jurisdictions with offshore O&G activities. Identified regulations were parsed into individual requirements and compared and contrasted with BSEE regulations. The main objective was to identify any gaps in the BSEE decommissioning regulations in order to recommend improvements in the regulations to BSEE.

### 12.1. United States

#### 12.1.1. Federal

##### ***BSEE***

30 CFR Part 250 contains the decommissioning regulations as enforced by BSEE. Subpart Q (250.1700ff) is the section dedicated to decommissioning regulations. General Requirements (250.1700-1709) include definitions of decommissioning, obstructions and facility; who accrues decommissioning obligations and the general requirements for decommissioning; when reports and applications need to be submitted; and BOP, blowout, and well-control fluid requirements. Remaining sections provide the regulations for Permanently Plugging Wells (250.1710-1717), Temporary Abandoned Wells (250.1721-1723), Removing Platforms and Other Facilities (250.1725-1731), Site Clearance for Wells, Platforms, and Other Facilities (250.1740-1743), and Pipeline Decommissioning (250.1750-1754). Refer to the Regulatory Matrix in Section 11.4 for additional details on the individual requirements covered by Subpart Q. 30 CFR 250.198 lists the documents incorporated by reference for 30 CFR 250. The only reference related to decommissioning regulations (Subpart Q) listed is the API RP 53, Recommended Practices for Blowout Prevention Equipment Systems for Drilling Wells, Third Edition, March 1997.

BSEE may grant a departure from the requirement to remove a nonproductive offshore O&G platform for conversion to an artificial reef if the structure becomes part of a state program. States with Artificial Reef Plans include Texas, Louisiana, Florida, Alabama, Mississippi, and California. The National Ocean Atmospheric Administration (NOAA) also publishes the National Artificial Reef Plan, a guide for artificial reef program managers and policy makers regarding how to understand artificial reef development.

The BSEE Idle Iron Policy (NTL 10-5) requires companies to dismantle and dispose of infrastructure after Plug and Abandonment (P&A) activities are complete. Any decommissioned facility that has no economically viable infrastructure is severely damaged or idle infrastructure on idle leases are considered “idle iron”. The policy was put in place to prevent environmental or safety incidents that could come about as a result of the “idle iron” being in place.

BSEE has issued Notices to Lessees and Operators (NTLs) related to decommissioning activities to clarify and add additional guidance to regulations.

### General NTLs

- NTL No. 2010-G05 Decommissioning Guidance for Wells and Platforms: This NTL, known as the “Idle Iron” policy, requires companies to decommission infrastructure on active leases that is not economically viable, is severely damaged, or is idle and to decommission all wells, structures, and pipelines on terminated leases or pipeline rights-of-way are, i.e. “idle iron”. The policy was put in place to establish an approach to ensure that idle infrastructure is decommissioned in a timely manner. The NTL also provides additional guidance and clarification on well and platform removal issues and provides definitions of “capable of production in paying quantities”, “downhole zonal isolation”, “no longer useful for operations”, and “toppled platform”.
- NTL No. 2010-P05 Decommissioning Cost Report Update: Notifies lessees and operators of the availability of a decommissioning cost report.
- NTL No. 2009-P04 Decommissioning of Pacific OCS Facilities: Provides guidelines for the permitting process for decommissioning platforms, pipelines, and other O&G facilities on the Pacific OCS. This NTL supersedes NTL 2001-P10 Decommissioning of Pacific OCS Facilities.
- NTL No. 2003-G02 Ultimate Recovery Abandonment and Bypassing of Zones: Informs lessees and operators that the GOM Office for Production and Development would be performing economic and conservation evaluations of requests to abandon producing zones, including the conditions under which lessees and operators must submit certain zone data prior to abandonment.
- NTL No. 98-26 Minimum Interim Requirements for Site Clearance (and Verification) of Abandoned Oil and Gas Structure in the Gulf of Mexico: Issued to update site clearance regulations.

### Financial NTLs

- NTL No. 2008-N07 Supplemental Bond Procedures: Clarifies procedures and criteria used to determine when a supplemental bond is required to cover potential decommissioning liability.

### Environmental NTLs

- NTL No. 2012-N07 Oil Discharge Written Follow-up Reports: Provides clarification on the type of information to be submitted in written follow-up reports for all oil discharges of one barrel or more.
- NTL No. 2012-N06 Guidance to Owners and Operators of Offshore Facilities Seaward of the Coast Line Concerning Regional Oil Spill Response Plans: Provides clarification and guidance on the preparation and submittal of a regional Oil Spill Response Plan.
- Joint NTL No. 2012-G01 Vessel Strike Avoidance and Injured/Dead Protected Species Reporting: Updates guidelines on how to implement monitoring programs to minimize the risk of vessel strikes to protected species and how to report observations of injured or dead protected species.
- NTL No. 2012-G01 Marine Trash and Debris Awareness and Elimination: Provides background and information on marine trash and debris awareness training.
- NTL No. 2009-G04 Significant OCS Sediment Resources in the Gulf of Mexico: Provides guidance for the avoidance and protection of significant OCS sediment resources in the GOM region.
- NTL No. 2008-G17 Incident and Oil Spill Reports: Provides clarification on the types of incidents to be reported, information no using the eWell Permitting and Reporting System, and specifies the information to be included in reports.

## ***Bureau of Ocean Energy Management (BOEM)***

30 CFR Part 550 regulates offshore oil and gas activities in the Outer Continental Shelf (OCS). Decommissioning specific regulations in 30 CFR 550 specify the decommissioning information that must be included in the Development and Production Plan (DPP) and Development Operations Coordination Document (DOCD) (550.225).

### ***U.S. Army Corps of Engineers (USACE)***

33 CFR Part 320 provides the general regulatory policies for the USACE. USACE has regulatory jurisdiction of coastal waters within three nautical miles offshore. Additional regulatory powers are also exercised over navigable waters in the OCS (33 CFR Part 320.2(b) and 33 CFR Part 322.3(b)). USACE issues Individual Permits (33 CFR Part 325), Letters of Permission (33 CFR 325.2(e)(1)) and Nationwide Permits (33 CFR Part 330) for offshore activities in the jurisdictional area of USACE. Section 10 of the River and Harbor Act of 1899 also prohibits the unauthorized obstruction or alteration of navigable waters of the United States. USACE has authorization to approve any construction, extraction, or depositing of material in these waters. USACE's authority was extended to artificial islands, installations, and other devices on the seabed to the limit of the OCS in the OCS Lands Act of 1953. The USACE does not have regulations that specifically address decommissioning.

### ***U.S. Environmental Protection Agency (EPA)***

The U.S. EPA does not have regulations that specifically address decommissioning of offshore structures, but such activities are covered by the general environmental regulations that cover air emissions, water quality, waste disposal, protection of biological resources, and other environmental aspects..

The Clean Water Act (CWA) pertains to the decommissioning of offshore O&G facilities through the National Pollution Discharge Elimination System (NPDES) Permit Program. NPDES permits are required for any discharges of pollutants to surface waters (CWA Section 301(a)) and are therefore necessary for decommissioning activities.

The National Environmental Policy Act (NEPA) (40 CFR 1500-1508) is a policy requiring federal agencies to integrate environmental values in their decision making. 40 CFR 1501.3 allows agencies to prepare an environmental assessment (EA) to assist in the decision making process. If the results conclude that significant adverse environmental effects may occur, then an Environmental Impact Statement (EIS) must be prepared. 40 CFR 1502 details the sections that an EIS must include. 40 CFR 1503 includes provisions for public comments on a Draft Environmental Impact Statement (DEIS), stating that comments should be requested of appropriate local and state agencies, Indian tribes (when the effects are on a reservation), and any agency that requested statements on the action proposed. The agency will also request comments from the applicant and the public.

NEPA encourages agencies to tier their impact statements. When a broad EIS has previously been prepared and a subsequent assessment is undertaken, the subsequent assessment only needs to summarize the issues previously discussed and concentrate on the issues specific to the subsequent action (40 CFR 1502.20). Programmatic NEPA analyses (PEA or PEIS) are used to evaluate actions that are broad in scope and therefore allow for tiering of future NEPA documentation. For example, BOEM



has prepared a PEIS for the OCS oil and gas leasing program<sup>49</sup> which assesses, among other impacts, the reasonably foreseeable impacts from common decommissioning activities. Site specific impacts would be covered in a later site specific EA or EIS.

### ***U.S. Coast Guard (USCG)***

Through the United States Aids to Navigation System (33 CFR Part 62 Subpart B) regulation, the USCG is responsible for marking obstructions in areas of navigation. Potential obstructions could be generated in the decommissioning process. The Aids to Navigation on Artificial Islands and Fixed Structures (33 CFR Part 67) regulation requires obstruction lights and fog signals to be operated on all fixed structures. The Control of Pollution by Oil and Hazardous Substances and Discharge Removal (33 CFR Part 153) regulation requires that any parties who cause the discharge of oil or hazardous substances to notify the USCG. The USCG will monitor and assist in the environmental response. Finally the Oil Pollution Act (OPA) of 1990 provides provisions for oil liability, prevention, preparedness, and cleanup related to offshore O&G facilities. The USCG does not have regulations that specifically address decommissioning.

### ***U.S. Department of Transportation (USDOT) Office of Pipeline Safety (OPS)***

The Abandonment or Inactivation of Facilities (49 CFR 192.727) requires that operators provide an operating and maintenance plan for decommissioning activities, as well as specific requirements that the abandoned pipelines be disconnected from all sources and supplies of oil or gas. The USDOT does not have regulations that specifically address offshore decommissioning.

### ***National Oceanic and Atmospheric Administration (NOAA)***

The Fisherman's Contingency Fund (43 U.S.C. 1482) was established to compensate fishermen for economic and property losses caused by oil and gas obstructions in the OCS. Fishermen who prove that they suffered losses as a result of damage from offshore oil and gas obstructions may be eligible for compensation. This revolving fund is comprised of assessments paid by offshore oil and gas interests.

### ***National Marine Fisheries Service (NMFS)***

Under the Endangered Species Act (ESA), the Marine Mammal Protection Act, and the Magnuson-Stevens Fishery Conservation and Management Act, the NMFS ensures that during decommissioning activities marine mammals, fish resources, and endangered marine species are not impacted. 50 CFR Part 223 details restrictions applicable to threatened marine and anadromous species; restrictions will vary depending on the threatened species specific to the area of the facility.

### ***U.S. Fish & Wildlife Service (USFWS)***

The USFWS also has authority under the ESA to ensure the protection of threatened and endangered species during decommissioning activities. The USFWS does not have regulations that specifically address decommissioning.

---

<sup>49</sup> BOEM, "Outer Continental Shelf Oil and Gas Leasing Program: 2012-2017, Final Programmatic Environmental Impact Statement", BOEM 2012-030, 2012.

## 12.1.2. States

### *Alabama*

Alabama Rules and Regulations of the State Oil and Gas Board of Alabama Governing Submerged Offshore Land Operations (Rule 400-6-10) provide the state specific regulations on offshore O&G activities in Alabama. In addition, Rule 400-2-8 documents Safety and Environment regulations. There is no section dedicated to decommissioning activities. Alabama also has a Rigs to Reefs Program in place.

Refer to Table 12-1, the State Comparison Regulatory Matrix, for further details on specific requirements.

### *Alaska*

The Alaska Administrative Code Title 22 Chapter 25 Article 2 covers the state regulations for the decommissioning offshore O&G facilities. The state regulations are fairly in depth, requiring the removal of all platforms, equipment, casings, and pilings unless a state or federal agency gives approval to leave it in place. The Alaska Administrative Code Title 18 Chapter 75 Articles 3 and 5 detail contingency plans and primary response actions for oil spills on offshore O&G facilities and vessels. Finally, under the authority of the Alaska Department of Environmental Conservation, the Alaska Administrative Code Title 18 Chapter 83 contains the state specific Pollution Discharge Elimination System regulations.

Refer to Table 12-1, the State Comparison Regulatory Matrix, for further details on specific requirements.

### *California*

Title 2 of the California Code of Regulations (2 CCR § 2124) specifies that on or before the expiration of a lease, the lessee shall, at the option of the State Lands Commission, either surrender the leased premises with all permanent improvements or remove such structures.

Title 14 of the California Code of Regulations (14 CCR § 1722 - 1749) contains specific plugging and abandonment procedures, including waste disposal, spill contingency plans, pipeline and well plugging, and site clearance requirements.

California Environmental Quality Act covers environmental impact review. The CEQA statute, California Public Resources Code § 21000 et seq., codifies a statewide policy of environmental protection. According to CEQA, all state and local agencies must give major consideration to environmental protection prior to approving public and private activities.

The Lempert-Keene Seastrand Oil Spill Prevention and Response Act, under the California Department of Fish and Wildlife Office of Spill Prevention and Response, covers all aspects of marine oil spill prevention and response in California.

The California Marine Resources Legacy Act was passed in 2010 and establishes a program administered by the Department of Fish and Wildlife to allow partial removal of offshore O&G structures. Similar to

other Rigs to Reefs programs, a portion of the cost savings that result from a partial removal would be apportioned to specific California State entities and funds.

Refer to Table 12-1, the State Comparison Regulatory Matrix, for further details on specific requirements.

### **Louisiana**

The Louisiana Oil Spill Prevention and Response Act (OSPRA) of 2003 provides the regulatory framework for spill response in the state. Parties involved in a threatened or actual unauthorized discharge of oil are required to develop a state oil spill contingency plan, the contents of which are detailed in OSPRA. Section 2469 of OSPRA (Derelict vessels and structures) details the responsibilities of operators in the removal of a vessel or structure “involved in an actual or threatened unauthorized discharge of oil in coast waters”. The Louisiana Administrative Code Title 43 (Natural Resources) contains the state well plugging procedures.

As mentioned above, the Louisiana Department of Wildlife and Fisheries runs an Artificial Reef Program. The program began in 1986 and to date 71 offshore O&G companies have participated in the program. Under the program, companies also donate half their realized savings over a traditional removal process into Louisiana’s Artificial Reef Trust Fund. Interested parties submit an application covering a number of factors including conservation, economics, fish and wildlife values, aesthetics, among others.

Refer to Table 12-1, the State Comparison Regulatory Matrix, for further details on specific requirements.

### **Mississippi**

Mississippi has state specific rules for drilling offshore wells (Rule OS-5) that include plugging and abandonment requirements. Rule OS-8 highlights requirements for liquid disposal and solid waste disposal. Rule OS-11 provides details on financial securities for wells and pipelines for offshore installations. Mississippi also has an Artificial Reef Program in place.

Refer to Table 12-1, the State Comparison Regulatory Matrix, for further details on specific requirements.

### **Texas**

The Texas Administrative Code Title 30 covers Environmental Quality regulations, including spill prevention and control (Chapter 327). The Railroad Commission of Texas has jurisdiction over wells in state waters and Statewide Rules 13 and 14 provide well plugging requirements. The Texas Artificial Reef Program is operated by the Texas Parks & Wildlife Department. It was created in 1990 through the Coastal Fisheries Division. For offshore (major) structures RCT requests U.S. Department of Army, Corps of Engineers to perform engineering and environmental reviews.

Refer to Table 12-1, the State Comparison Regulatory Matrix, for further details on specific requirements.

## 12.2. Other IRF Member Countries

### **Australia**

The federal entity in Australia is the National Offshore Petroleum Safety and Environmental Management Authority (NOPSEMA), which functions and powers conferred on it under the Offshore Petroleum and Greenhouse Gas Storage Act 2006 (OPGGGS Act) and its regulations. The OPGGS Act primarily provides authority to regulate health and safety, well integrity and environmental management of petroleum exploration and development activities in Australia's offshore areas beyond the first three nautical miles of the territorial sea. Other offshore facilities that are within the first three nautical miles are regulated by State and Territory legislation.

NOPSEMA is a cost recovery agency and the Offshore Petroleum and Greenhouse Gas Storage (Regulatory Levies) Act 2003 enables specific levies for Occupational Health Safety, Well Integrity and Environmental Management regulatory activities.

The NOPSEMA regulations related to offshore O&G activities are- Select Legislative Instrument 2011 No. 54. - Offshore Petroleum and Greenhouse Storage (Resource Management and Administration) Regulations 2011, Statutory Rules 1999 No. 228 - Offshore Petroleum and Greenhouse Gas Storage (Environment) Regulations 2009, Select Legislative Instrument 2009 No. 382 - Offshore Petroleum and Greenhouse Gas Storage (Safety) Regulations 2009, and Statutory Rules 2004 No. 315 - Offshore Petroleum and Greenhouse Gas Storage (Regulatory Levies) Regulations 2004. Select Legislative Instrument 2011 No. 54 stipulates that operators must seek approval from NOPSEMA prior to any abandonment activities. The process involves an overall abandonment plan as well as an environmental assessment plan.

Refer to Table 12-2, the International Comparison Regulatory Matrix, for further details on specific requirements.

### **Brazil**

The Brazilian National Petroleum Agency (ANP) is the main regulating body associated with offshore O&G decommissioning. Overall obligations for decommissioning are in the specific Concession Agreement that the operator enters into with ANP, but general technical requirements and surrender of acreage are covered in ANP's Ordinance No. 25/2002. While decommissioning, the operators must all comply with applicable environmental laws and international best practices as laid out in International Conventions.

Refer to Table 12-2, the International Comparison Regulatory Matrix, for further details on specific requirements.

### **Canada**

The Canadian federal government controls O&G activities on frontier lands and each province also has their own specific regulations for activities in their province. The Canada Oil and Gas Operations Act highlights provisions relating to well abandonment, including spills and debris. The Canadian

Environmental Assessment Act (CEEA) 2012 requires operators to submit an environmental assessment for projects that considers factors including cumulative effects, mitigation measures, and public comments. Nova Scotia and the Government of Canada implemented the Canada-Nova Scotia Offshore Petroleum Resources Accord Implementation Act as an agreement on how to manage offshore petroleum resources.

Refer to Table 12-2, the International Comparison Regulatory Matrix, for further details on specific requirements.

### **Denmark**

Regulators of offshore oil and gas licensing and the offshore environment, The Danish Energy Agency (DEA), Danish Environmental Protection Agency (DEPA), and the Danish Maritime Authority (DMA) provide oversight in the determination of the decommissioning operations. DEPA regulates the environmental action plans, discharge permits, and oil and chemical spill contingency plans through the Act on Protection of the Marine Environment. Through Orders (No. 35 and No. 883), the DMA provides financial liability information for oil spills from marine vessels. The Danish Working Environment Authority (DWEA) regulates how the decommissioning work to be carried out with the Offshore Safety Act.

Refer to Table 12-2, the International Comparison Regulatory Matrix, for further details on specific requirements.

### **Mexico**

There are no specific decommissioning obligations for contractors from the National Hydrocarbons Commission (CNH); however specific decommissioning and abandonment provisions are specified in contracting guidelines executed with the contractor. Typically, agreements require that the contractor be responsible for all expenses associated with the decommissioning activities and the contractor will be liable for any problems arising from decommissioning for ten years following the termination of the contract.

The General Law of Ecological Balance and Environmental Protection (LGEEPA) requires the submission of an Environmental Impact Assessment (EIA) which may cover decommissioning activities. The inclusion of decommissioning activities is at the CNH discretion.

Refer to Table 12-2, the International Comparison Regulatory Matrix, for further details on specific requirements.

### **The Netherlands**

The State Supervision of Mines (an agency of the Ministry of Economic Affairs) supervises offshore O&G activities. The current mining legislation consists of the Mining Act, the Mining Decree, and the Mining Regulation. Decommissioning specific portions of the legislation can be found in the Mining Decree 5.1.4, 5.2.3, and 5.2.4, covering installations located above and below surface water.

Refer to Table 12-2, the International Comparison Regulatory Matrix, for further details on specific requirements.

### ***New Zealand***

The Maritime Transport Act 1994 was put in place to limit the input of harmful substances into the sea, and details oil spill response strategies of vessels. The Health and Safety Employment Regulations stipulate that decommissioning procedures must be conducted in a safe manner. A revised safety case that covers decommissioning operations has to be submitted to WorkSafe NZ prior to activities commencing.

Refer to Table 12-2, the International Comparison Regulatory Matrix, for further details on specific requirements.

### ***Norway***

The Petroleum Act is the regulatory authority for decommissioning activities in Norway. The Act requires a decommissioning plan, impact assessment, and plans for public consultation. Norwegian regulations do not have specific abandonment requirements. Instead, the Act references NORSOK, the Norwegian petroleum standards that were developed by the Norwegian petroleum industry, to ensure safety and efficacy for petroleum industry operations. NOROSK Standard D-010, in particular, provides detailed guidance on well plugging procedures.

Refer to Table 12-2, the International Comparison Regulatory Matrix, for further details on specific requirements.

### ***United Kingdom (UK)***

The UK has robust regulations and requirements associated with offshore O&G activities. The UK Petroleum Act 1998, as amended by the Energy Act 2008, details the requirements for decommissioning of offshore installations. The Department of Energy and Climate Change (DECC) is in charge of ensuring that operators are in compliance with the regulations. The leading trade association for the UK offshore O&G activities, UK Oil & Gas, issues guidelines for decommissioning activities to assist operators.

Additional safety, environmental protection, and pollution prevention laws and regulations are also in place under the regulatory framework in the UK that may affect decommissioning activities. Agencies involved include the DECC; Department of the Environment Transport and the Regions; Health and Safety Executive; and Maritime and Coastguard Agency, among others.

Refer to Table 12-2, the International Comparison Regulatory Matrix, for further details on specific requirements.

## **12.3. Other Jurisdictions**

### ***International Conventions***

The Geneva Convention on the Continental Shelf 1958, in particular Article 5, stipulates that any activities in the continental shelf must not result in interference with navigation, fishing, or the conservation of the living resources of the sea. With respect to decommissioning, the Convention states that any installations which are abandoned must be removed in their entirety. There are 43 signatories and 58 parties of the Convention<sup>50</sup>.

The UN Convention on the Law of the Seas 1982 (UNCLOS) allows for partial removal of offshore structures provided that International Maritime Organization (IMO) criteria are met, specifically that the partial removal should have regard for fishing, protection of the marine environment, and the rights of other states. The location of the remaining portions of the installation must be publicly stated. UNCLOS has 157 signatories and 167 parties<sup>51</sup>.

IMO Guidelines of 1989 require the complete removal of all structures in water less than 100m and structures less than 4,000 tons. In addition, installations after 1998 must be designed to be removed when they are ready to be decommissioned.

The London Convention provides specific guidance for dumping platforms at sea as well as providing guidance for the placement of artificial reefs. The objective of the Convention is to protect the marine environment from human activities. There are 87 parties of the London Convention<sup>52</sup>.

The Convention for the Protection of the Marine Environment of the North-East Atlantic 1992 (OSPAR) was put in place to control disposal of waste at sea and discharges to land. The OSPAR Decision 98/3 provides additional details on specific decommissioning requirements. There are 16 Contracting Parties to OSPAR<sup>53</sup>.

## 12.4. Regulatory Matrix

Based on the regulations described above, Tables 12.1 and 12.2 provide matrices of the specific requirements by State and Country, respectively, to compare across all the regulating bodies.. The US regulatory requirements in the matrix reflect requirements across all federal agencies and the international requirements noted in this table also span across different agencies.

---

<sup>50</sup> [https://treaties.un.org/Pages/ViewDetails.aspx?src=TREATY&mtdsg\\_no=XXI-4&chapter=21&lang=en](https://treaties.un.org/Pages/ViewDetails.aspx?src=TREATY&mtdsg_no=XXI-4&chapter=21&lang=en)

<sup>51</sup> [http://www.un.org/depts/los/reference\\_files/chronological\\_lists\\_of\\_ratifications.htm](http://www.un.org/depts/los/reference_files/chronological_lists_of_ratifications.htm)

<sup>52</sup> <http://www.imo.org/OurWork/Environment/LCLP/Pages/default.aspx>

<sup>53</sup> [http://www.ospar.org/content/content.asp?menu=00340108070026\\_000000\\_000000](http://www.ospar.org/content/content.asp?menu=00340108070026_000000_000000)

Table 12-1. State Comparison Regulatory Matrix<sup>54</sup>

	FEDERAL	AK	AL	CA	LA	MS	TX
<b>Plans and Approvals</b>							
<b>Decommissioning Plan, Application, or Approval</b>	30 CFR 250.1704. Initial platform removal application, final platform removal application, pipeline decommissioning application, and Application for Permit to Modify required. Dates vary by application type (2 years prior for platforms and before decommissioning pipelines). Requirements vary by application type.	20 AAC 25.105. Application for Sundry Approvals must be submitted prior to well abandonment, plugging, or suspension. Dates are not provided. Applications include reason for abandonment and statement of proposed work.	State Oil and Gas Board of Alabama Administrative Code 400-6-10. Prior to abandonment activities, the operator must provide the Supervisor with the proposed methods and procedures. Abandonment cannot begin until approval is given by the Supervisor.	CA CCR Title 14 Division 2 Chapter 4 Subchapter 1.1 Article 3.1745. Plugging and abandonment activities require approval from the Supervisor. Applications include a detailed work plan. Any applications without response in 10 days are deemed to be approved	43 LAC 19.137. Notification of plugging must be made in writing to the local District Office and once approved will receive a work permit.  LAC 43:XI.311. A procedural plan for site clearance verification of platform, well or structure abandonment shall be developed by the lessee and submitted to the commissioner of conservation for approval with the permit application for platform or structure removal.	Rule OS-5. Plugging and abandonment operations must not begin without approval from an authorized representative of the board.  State Statue- 53-3-101. Need a permit from State Oil and Gas Board for construction on offshore facilities.	Statewide Rule 14, Plugging. Operator must submit a "Notice of Intention to Plug and Abandon" prior commencing abandonment procedures.
<b>Environmental Impact, Damage Prevention, or Rehabilitation Plan</b>	30 CFR 250.1712, 1726, 1727, 1752: Brief assessment of the environmental impacts of the removal operations and procedures and mitigation measures to take to minimize such impacts	18 AAC 75.405. At least 60 days before submitting an application for approval of a new oil discharge prevention and contingency plan.  18 AAC 75.425. Under the umbrella of environmental conservation policy. The operator must submit Oil Discharge Prevention and Contingency Plan must be in a form that is usable as a working plan for oil discharge prevention, control, containment, cleanup, and disposal.	335-8-1-08. (2) Upon receipt of a permit application for a use subject to the management program, the state agency shall send to the Department an informational copy of the complete application along with any supporting documents submitted by the applicant. Upon receipt, the Department shall begin its review process and shall initiate appropriate interagency coordination.	CA CCR Title 14 Division 2 Chapter 4 Subchapter 2 Article 3.1776. The operator must submit a plan for lease restoration, which must begin within 3 months and completed within one year of abandonment of last well.	LAC 43:XI.311. Rehabilitation Information provided under procedure plan.	Statewide Rule 28. All wastes and other materials, including petroleum-contaminated soil, shall be removed from the location and associated sites and disposed of in accordance with appropriate permit(s) or regulations(s); provided, however, that petroleum-contaminated soil may be approved by the Supervisor for on-site remediation.	16 TAC 8(d)(5). Permits to store, handle, treat and dispose of oil and gas wastes are issued under Statewide Rules 8(drilling fluid disposal, landfarm/landtreatment), 9, 46 (disposal/injection well), and 57 (reclamation plant). U.S. Army Corps of Engineers - Public notice (12/2012) RGP-11 – Submit plans for restoration of the surface under Surface Use and Operations Plan.

<sup>54</sup> Refer to the regulation referenced for additional details and specifics for requirements. This table does not include all specifics for the requirements mentioned.



	FEDERAL	AK	AL	CA	LA	MS	TX
<b>Financial Assurance</b>	<p>30 CFR 556 Subpart I. Lease bond for exploration - \$200,000 – Individual, \$1 million – area wide; for development/production \$500,000 – Individual, \$3 million – area wide. Supplemental/additional bonds will vary case by case basis.</p> <p>30 CFR 556.53(e). The Regional Director will determine the amount of supplemental bond required to guarantee compliance. The Regional Director will consider potential underpayment of royalty and cumulative obligations to abandon wells, remove platforms and facilities, and clear the seafloor of obstructions in the Regional Director's case-specific analysis. Operator may also apply for supplemental bond waiver.</p>	<p>20 AAC 25.025(b). A bond and, if required, security must be in the amount of not less than \$100,000 to cover a single well or not less than \$200,000 for a blanket bond covering all of the operator's wells in the state, except that the commission will allow an amount less than \$100,000 to cover a single well if the operator demonstrates to the commission's satisfaction in the application for a Permit to Drill (Form 10-401) that the cost of well abandonment and location clearance will be less than \$100,000.</p>	<p>State Oil and Gas Board of Alabama Administrative Code 400-1-2-.03 details bonding requirements based on depth of well for oil and gas operations, including assurances against any pollution of the sea, and all surface and groundwater.</p>	<p>CA Pub. Res. Code 3205. Operators of offshore wells must post a bond (an amount determined by the State Oil and Gas Supervisor) to cover abandonment costs. The amount can be adjusted by the Supervisor no more than once every 3 years.</p>	<p>43 LAC 19.104. Financial security remains in effect until after plugging and abandonment and site restoration is complete, pending inspection.</p>	<p>Rule OS-11. A bond of \$100,000 for each well or pipeline, or \$200,000 for all wells and pipelines, must be filed with the Board before drilling any offshore wells.</p>	<p>S.B. 1103. Requires financial security for operators of oil and gas facilities. Financial securities options, including a blanket bond or lien on field equipment. (16 TAC 3.78)</p>
<b>Public Consultation</b>	<p>National Environmental Protection Act. Environmental Impact Statements are available for public comment for a minimum of 45 days.</p>	<p>20 AAC 25.565(b). The commission will promptly schedule a public hearing on the plan and give public notice of the hearing in accordance with AS 31.05.050(b). The hearing will be scheduled at least 10 days after the date of the public notice.</p>	<p>State Oil and Gas Board of Alabama Administrative Code 335-8-1-.14(4) Public notice may not be required for modifications, and permit extensions or renewals in which the impact is expected to be equal to or less than that originally permitted. All editorial changes and permit name changes shall not be subject to the public notice requirements of this rule.</p>	<p>Marine Resources Legacy Act. Application for partial removal must be made available for public comment and a public hearing must be held in the county nearest to the site of the offshore structure.</p>	<p>43 LAC 19.137. In the event any owner(s) responsible for plugging any well fails to do so, and after a diligent effort has been made by the department to have said well plugged, then the commissioner may call a public hearing to show cause why said well was not plugged.</p>	<p>State Statue- 53-3-101. The State Oil and Gas Board upon the application of any interested person shall, after notice as herein provided, hold a hearing to consider the need for the operation. Rule 28. Any interested party at any time shall have the right to review by the Board upon notice and hearing with respect to the administration of any provision hereof.</p>	<p>16 TAC 3.7. If the director determines that a hearing is in the public interest, a hearing shall be held.</p>
<b>Removal Guidelines</b>							

	FEDERAL	AK	AL	CA	LA	MS	TX
<b>Well P&amp;A</b>	30 CFR 250.1715. Generally requires minimum 200 ft long cement plugs to isolate oil, gas, and freshwater zones or to plug casings, with additional bridge plugs or cement retainers allowed or required in some situations.	22 AAC 25.112 and 115. Minimum requirements for plugging uncased wellbores are by the displacement method (cement plug generally placed from 100 ft below the base to 50 ft above the freshwater strata) or by the downsqueeze method using a retainer or production packer set from 50 to 100 ft from above the casing shoe.	State Oil and Gas Board of Alabama Administrative Code 400-6-10. The storage cavity will be filled with water saturated to a brine concentration of 90% or greater and a bridge plug will be placed within 150 ft above the cement plug in the production casing. 400-2-4-.09. To facilitate casing removal upon well abandonment, cement may be washed out or displaced to a depth not to exceed forty (40) feet below the waters floor, unless otherwise approved by the Supervisor.	CA CCR Title 14 Division 2 Chapter 4 Subchapter 1.1 Article 3.1745. Cement plugs to total depth or at least 100 feet below each oil or gas zone in uncased holes, with minimum 200 ft cement plugs across an intrazone freshwater-saltwater interface.	43 LAC 19.137. A cement plug of at least 100 ft must be placed to the top of the screen or liner.	Rule OS-5. Generally requires cement plugs to extend a minimum of 100 ft below the casing/bottom to 100 ft above the casing/top of any oil, gas, or freshwater zones, with additional retainers and bridges required in some situations	Statewide Rule 14, Plugging. Operator must follow requirements set forth in the approved "Notice of Intention to Plug and Abandon" form. Operators may only use approved cementers to plug their well.  14 TAC 3.14. This plug shall be a minimum of 100 feet in length and shall extend at least 50 feet above the shoe and at least 50 feet below the shoe.
<b>Structures</b>	30 CFR 250.1728. Platforms and facilities must be removed to at least 15 ft below the mudline. Alternate depths may be approved in some situations.	22 AAC 25.172. All obstructions must be removed to a depth of at least 1 ft below the mudline for fixed offshore platforms and 5 ft for a rig or floating vessel. One year after abandonment of a well drilled from a beach, artificial island, or natural island, operator must ensure the integrity of the location within one year of abandonment. The commission will conduct an inspection to verify location condition.	State Oil and Gas Board of Alabama Administrative Code 400-2-4-.13. (1) All casing, wellhead equipment, platforms, fixed structures, and pilings shall be removed to a depth of at least fifteen (15) feet below the waters floor.	CA CCR Title 14 Division 2 Chapter 4 Subchapter 1.1 Article 3.1745. All casing and anchor piling cut and removed no more than 5 ft below the ocean floor. Ocean floor must be cleared of any obstructions, unless prior approval from marine navigation and wildlife agencies	LAC 43:XI.311. Well and platform locations shall be cleared of all obstructions. All casing and anchor piling shall be removed to a depth of at least 10 feet below the mudline.	Rule OS-5. All casing and piling should be removed to at least 15 ft below the waters' floor and the location must be dragged to clear any obstructions.	31 TAC 9.91. Remove all equipment, structures, machinery, tools, supplies, and other items on the property and otherwise restore the property to the condition it was in immediately preceding issuance of that lease.

	FEDERAL	AK	AL	CA	LA	MS	TX
<b>Location Clearance</b>	30 CFR 250.1740. The site must be cleared of all obstructions. A trawl must be dragged across the site for water depths less than 300 ft. For water depths greater than 300 ft, sonar equipment may be used to ensure the site is clear.	22 AAC 25.172. All obstructions must be removed to a depth of at least 1 ft below the mudline for fixed offshore platforms and 5 ft for a rig or floating vessel. One year after abandonment of a well drilled from a beach, artificial island, or natural island, operator must ensure the integrity of the location within one year of abandonment. The commission will conduct an inspection to verify location condition.	State Oil and Gas Board of Alabama Administrative Code 400-2-4-.13. (1) All casing, wellhead equipment, platforms, fixed structures, and pilings shall be removed to a depth of at least fifteen (15) feet below the waters floor.	CA CCR Title 14 Division 2 Chapter 4 Subchapter 1.1 Article 3.1745. All casing and anchor piling cut and removed no more than 5 ft below the ocean floor. Ocean floor must be cleared of any obstructions, unless prior approval from marine navigation and wildlife agencies	LAC 43:XI.311. Well and platform locations shall be cleared of all obstructions. All casing and anchor piling shall be removed to a depth of at least 10 feet below the mudline.	Rule OS-5. All casing and piling should be removed to at least 15 ft below the waters' floor and the location must be dragged to clear any obstructions.	U.S. Department of Army, Corps of Engineers, Fort Worth District. Notice to Oil and Gas Lessees and Operators - #10. Submit plans for restoration of the surface, with practices necessary to rehabilitate all disturbed areas including any access roads no longer needed.
<b>Pipelines</b>	30 CFR 250.1751 and 1752. A pipeline may be decommissioned in place after approval by pigging and flushing the pipeline before filling seawater and plugging. The pipeline must then be buried at least 3 ft below the seafloor or have each end covered with protective concrete mats. Prior to removal, pipelines must also be pigged and flushed.	22 AAC 15.172. Upon abandonment of an offshore production facility, unless agreed to by the surface owner, the operator is required to remove all materials, supplies structures, and installations from the location.	State Oil and Gas Board of Alabama Administrative Code 400-3-4-.16. When a location is abandoned, all material, debris and equipment, such as drill pipe, casing, tubing, treaters, separators, tanks, and other production, injection, and above-ground pipeline equipment and materials shall be removed from the location.	CA CCR Title 14 Division 2 Chapter 4 Subchapter 2 Article 3.1776. Pipelines must be purged of oil and filled with an inert material.	43 LAC 5.30141 (oil) & 11.2927 (gas). A pipeline may be abandoned in place must be disconnected, filled with water or inert materials, and sealed at the ends. (49 CFR 195.59 (oil) & 49 CFR 192.727 (gas))	Statewide Rule 28 – Remove above ground pipelines. All underground or buried lines shall be flushed and capped at both ends.	16 TAC 7.70. A pipeline may be abandoned in place must be disconnected, filled with water or inert materials, and sealed at the ends. (49 CFR 195.59 (oil) & 49 CFR 192.727 (gas))

	FEDERAL	AK	AL	CA	LA	MS	TX
<b>Temporary Abandonment</b>	30 CFR 250.1721. Generally a 100-ft bridge or cement plug must be set. An application to modify must be submitted prior to temporary abandonment.	22 AAC 25.072. The operator must provide a description of condition of the wellbore upon shutdown and when the operations will resume. Operations must resume within 12 months.	State Oil and Gas Board of Alabama Administrative Code 400-1-4-.17. (1). An operator may request that a well be placed in a temporarily abandoned status by submitting a written request to the Supervisor describing its future utility. A well may be classified as a temporarily abandoned well upon a showing that the well has future utility. The well will be placed in a temporarily abandoned status for a period of not more than one (1) year.	CA CCR Title 14 Division 2 Chapter 4 Subchapter 1.1 Article 3.1745. Wells must be mudded and cemented as under well P&A requirements, with certain requirements not needed. A mechanical bridge plug must be set in the well between 15 and 200 ft below the ocean floor for platform sites.	43 LAC 19.137. Any drilling well which is to be temporarily abandoned and the rig moved away, shall be mudded and cemented as it would be for permanent abandonment, except a cement plug at the surface may be omitted.	Rule OS-5. Temporarily abandoned wells must be mudded and cemented as under well P&A requirements, with certain requirements not needed. A mechanical bridge plug must be set in the well between 15 and 200 ft below the ocean floor for platform sites.	14 TAC 3.14. Plug shall be a minimum of 100 feet in length and shall extend at least 50 feet above the shoe and at least 50 feet below the shoe. An application must be submitted prior to temporary abandonment.
<b>Removal (Partial/Full, Full Only, Artificial Reefs)</b>	30 CFR 250.1730. Partial removal or toppling in place may be allowed if the structure becomes part of a State artificial reef program and the structure satisfied the USCG navigational requirements.	22 AAC 25.105. A well must be abandoned before the full removal of the drill rig.	Artificial Reef Law. Materials/vessels must be inspected and permitted by the USACE, Department of Conservation and Natural Resources, and Marine Resources Division.	Marine Resources Legacy Act. Allows partial removal of platform if the Ocean Protection Council determines there is a net benefit to the marine environment. Applicant must submit application with a plan to manage the structure after partial removal and provide an opportunity for public comment. Cost savings are apportioned to the CA Endowment for Marine Preservation, General Fun, Fish and Game Preservation Fund, Coastal Act Services Fund, and the Board of Supervisors of the local county. The percent of cost savings transmitted to the above are 55% for approvals by 2017, increasing to 80% after 2023.	Louisiana Fishing Enhancement Act. Created the Artificial Reef Program in 1986. The structure must have an 85 ft minimum clearance below the mean low sea level of the water surface. The operator must donate a specified amount to the Conservation Fund.	Mississippi Artificial Reef Plan. The structure must have a 50 ft minimum clearance below the mean low sea level of the water surface. The operator must donate a specified amount to the Artificial Reef Fund.	Texas Artificial Reef Plan. Operators must donate half their realized savings from not having to take the rigs to shore to the Texas Artificial Reef Fund.

	FEDERAL	AK	AL	CA	LA	MS	TX
<b>Material Disposal</b>	30 CFR 250.1726. Platform or other facility disposal plans must be submitted during initial removal application.	18 AAC 75.425. Site disposal plans must be submitted as Oil Discharge Prevention and Contingency Plan.	State Oil and Gas Board of Alabama Administrative Code 335-8-2-.10 (1) All new energy facilities located wholly or partially within the coastal area and which require a state agency permit must also receive coastal consistency from the Department prior to any land clearing or construction.	CA CCR Title 14 Division 2 Chapter 4 Subchapter 2 Article 3.1775 and 1776. Oilfield waste must be disposed of in a manner as not to cause damage to life, health, property, surface waters, or natural resources and must conform to Department of Toxic Substances Control Requirements	43 LAC 19.503. Assess the waste generated and send the waste to approved sites (in accordance with the type of the waste generated.)	Rule OS-8. Liquid waste materials that may be harmful to aquatic life must be treated to avoid the disposal of harmful substances into the waters. Solid waste may not be disposed of into the waters without prior approval of the supervisor. Without approval, they must be incinerated or transported to shore for disposal.	16 TAC 3.98 Activities associated with the operation, abandonment, and proper plugging of wells subject to the jurisdiction of the commission to regulate the exploration, development, and production of oil or gas or geothermal resources.
<b>Environmental</b>							
<b>Spill Response</b>	30 CFR 250. Oil-Spill Response Plans must demonstrate that the operator can respond quickly and effectively when oil is discharged from the facility. The plan must be submitted prior the facility being used.	18 AAC 75.425. An Oil Discharge Prevention and Contingency Plan must be submitted to the DEC.	State Oil and Gas Board of Alabama Administrative Code 400-2-8. Operators must have an area contingency spill response plan.	CA CCR Title 14 Division 2 Chapter 4 Subchapter 2 Article 3.1743. A spill contingency plan must be on file with the Division prior to operations. All spills must be reported to agencies specified in the CA Oil Spill Disaster Contingency Plan and in the National Oil Hazardous Substances Pollution Contingency Plan.	OSPAR Section 2459. The State will develop and distribute to the public a contingency plan for actual or threatened unauthorized discharges.	Rule OS-8. Each operator shall have an emergency plan for initiating corrective action to control and remove pollution and such plan shall be filed and reviewed with the Supervisor. Corrective action taken under the plan shall be subject to modification when directed by the Supervisor.	30 TAC 327. Spills must be immediately abated and contained. Spills large enough to create a sheen must be reported.
<b>Environmental Liability Specification</b>	30 CFR 553. Oil Spill Financial Responsibility (OSFR) for covered offshore facilities is dependent on the worst case oil-spill discharge volume, varying from \$10,000,000 to \$150,000,000. (Also see financial assurance)	18 AAC 75.325. For offshore oil incidents, \$91,500,000 per incident financial responsibility is required	400-2-2-.03 For Offshore oil and gas. Case by case basis by MD of <6,000' with \$100,000 & >6,000' with \$500,000. Blanket bond of one million (\$1,000,000) may be conditioned upon the same requirements as set forth for well bonds, except that a blanket bond may apply to more than one well.	CA CCR Title 14 Division 1 Subdivision 4 Chapter 2 Financial Responsibility. Financial responsibility is \$12,500 times the worst case spill volume (bbl), but not less than \$1,000,000 or more than \$30,000,000. The liable facility must submit an application for a Certificate of Financial Responsibility (COFR).	OSPAR Section 2479. Mobile offshore drilling units are liable for the greater of \$1,200 per gross ton or \$2 million (vessel of 3,000 gross tons or less) or \$10 million (vessel of 3,000 gross tons or more) for unauthorized discharges of oil.	Order # 201-51. Rule 4. (c) Under Permit to Drill Rule: Financial Responsibility, the amount required is by depth in feet, follows as: Zero – 10,000' -- \$20,000; 10,001' – 16,000' -- \$30,000; 16,001 – or more -- \$60,000. The board may allow blanket financial responsibility instrument of \$100,000, with coverage of one or more wells.	Texas Natural Resources Code Title 3, Subtitle B, Chapter 91.104. Requires the operator to file a bond, letter of credit, or cash deposit to place liability on the operator for environmental incidents.

	FEDERAL	AK	AL	CA	LA	MS	TX
<b>Discharge Permits</b>	NPDES Permit Program. Required for any discharges of pollutants to surface waters	18 AAC 83. Offshore oil and gas rigs are required to get an APDES permit. The facility is considered a new discharger only for the duration of its discharge in an area of biological concern.	State Oil and Gas Board of Alabama Administrative Code 400-2-8. Nothing can be discharged into waters until 7 days after appropriate permits have been submitted to the board.	CA CCR Title 2 Division 3 Chapter 1 Article 3. 2122. Pollution and contamination of the ocean and tide lands is prohibited. No oil, tar, residuary product of oil or well refuse may be discharged into the ocean.	LPDES Permit LAG260000. Water Discharge Permit (LPDES) required for oil and gas exploration, development, and production facilities located in the territorial seas of LA.	Rule OS-9 – Needs appropriate regulatory supervisor’s approval on discharging into the waters offshore provided the water quality meets standards established	TPDES Permit Program. The Railroad Commission of Texas regulates discharges of pollutants from oil and gas activities.
<b>Protection of Natural Resources</b>	Endangered Species Act, Marine Mammal Protection Act, Magnuson-Stevens Fishery Conservation and Management Act: Ensures that marine mammals, fish resources, and endangered marine species are not impacted	22 AAC 25.172. One year after abandonment of a well drilled from a beach, artificial island, or natural island, operator must ensure the integrity of the location within one year of abandonment.	State Oil and Gas Board of Alabama Administrative Code 400-2-8. Requires operators to work in a manner that will not pollute the surrounding environment.	CA CCR Title 14 Division 2 Chapter 4 Subchapter 2 Environmental Protection. Well site and lease restoration must be carried out in a manner to protect the surrounding environment. Well sites shall be returned to as near a natural state as practicable.	43 LAC 11.311. All abandoned well and platform locations shall be cleared of all obstructions present as a result of oil and gas activities unless otherwise approved by the commissioner of conservation.	Statewide Rule 45. Waste by pollution of air, surface waters and soils prohibited.	16 TAC 3.8 Water Projection. No person conducting activities subject to regulation by the commission may cause or allow pollution of surface or subsurface water in the state.
<b>Environmental Inspection</b>	BSEE IIPD 2012-03. BSEE will conduct scheduled and unannounced inspections to verify compliance with all environmental laws and regulations, lease stipulations, mitigation measures, conditions of approval, and other environmental requirements.	22 AAC 25.172. The commission will conduct an inspection to verify location condition after abandonment.	ALA 9-17-6. Conduct field inspections of oil and gas wells and facilities for compliance with oil and gas laws, rules, regulations, and orders and directives issued by the Board, and prevention of adverse impacts to public health and safety and the environment.	CA CCR Title 14 Division 2 Chapter 3 1723.7. An Environmental Inspection will be conducted post-abandonment to ensure that CA CFR Title 14, Subchapter 2 requirements are adhered to.	43 LAC 19. Performs unannounced inspections to verify compliance with all environmental laws and regulations, lease stipulations, mitigation measures, conditions of approval, and other environmental requirements under title 43 regulations and title 30 LA Law – 30:4.	Title 53-1-17. Board have the authority to make investigations and inspections; to examine properties, leases, papers, books and records, including drilling records and logs; to examine, check, test and gauge oil and gas wells, tanks, refineries, and modes of transportation	S.B. 68 (1917) – Law gives authority to perform inspections where field agents perform risk based inspections. Inspectors create daily reports from the field which detail inspection activities of wells and enforcement of the oil and gas conservation laws.
<b>Health and Safety</b>							
<b>Decommissioning Specific Employee Health and Safety</b>							

\*DISCLAIMER – The blank(s) in the table entails that regulations were not found with the resources that were allocated to the project.

Table 12-2. International Comparison Regulatory Matrix<sup>55</sup>

	UNITED STATES	AUSTRALIA	BRAZIL	CANADA	DENMARK	MEXICO	THE NETHERLANDS	NEW ZEALAND	NORWAY	UNITED KINGDOM
<b>Plans and Approvals</b>										
<b>Decommissioning Plan, Application, or Approval</b>	30 CFR 250.1704. Initial platform removal application, final platform removal application, pipeline decommissioning application, and Application for Permit to Modify required. Dates vary by application type (2 years prior for platforms and before decommissioning pipelines). Requirements vary by application type and location.	SR 1999 # 228.5A. Submission of an offshore project proposal for decommissioning a facility, or pipeline. Approval required.	ANP Ordinance No. 25/2002 Chapter 3 Art 4. and 5. Written notice to the ANP and approval is required before any abandonment activities can begin	NEB Act. Guide K – Submit Decommissioning facilities plan including disposition of associated piping, supports and foundations.	The Offshore Safety Act Section 31. Before a fixed offshore installation is dismantled, the operator must receive approval from the supervising authority. The application must include an updated safety case.	National Agency for Industrial Safety and Environmental Protection for the Hydrocarbon’s Sector Act. Requires operators to develop and execute facilities life cycle program (w/ abandonment and decommissioning of physical structures), prove compliance with regulations through external auditor reports.	Mining Decree 5.1.4 Article s 39 and 40: Closing plan must contain information including how the removal will be conducted, when the removals commence, and planned time to closure, among others. Approval must be given by the Minister of the State Supervision of Mines.	Health and Safety in Employment (Petroleum Exploration and Extraction) Regulations Schedule 2. Decommissioning procedures must be described in safety case and must be done in a safe manner.	The Petroleum Act Sections 5.1 and 5.2 and Regulation pursuant to the Petroleum Act Sections 43, 44, 45: Decommissioning plan must deal with disposal and impact assessment and may contain proposed disposal of several facilities	The Petroleum Act 1998 Part IV Sections 29, 30, 31, and 32. The operator must submit a decommissioning program that will be approved by the Secretary of State. The approval may come with or without modifications, in conjunction with rough draft submittal and preliminary meetings and with DECC.
<b>Environmental Impact, Damage Prevention, or Rehabilitation Plan</b>	30 CFR 250.1712, 1726, 1727, 1752: Requires environmental assessment of the environmental impacts of the removal operations and procedures and mitigation measures to take to minimize such impacts	SR 1999 # 228.5A. Submission of an environmental plan (or its revision) under the offshore project proposal for decommissioning a facility, or pipeline. Approval required.	Ordinance 422/2001. An EIA must be prepared for offshore oil and gas activities. Specificity of the EIA will vary depending on the sensitivity of the area being developed.	Canadian Environmental Assessment Act (CEA): Impact assessment must consider factors including cumulative effects, mitigation measures, and public comments	Act on the Protection of the Marine Environment Chapter 8a. Environment action plans must be developed for offshore activity to limit the impacts on the environment within the limits set through national and international legislation.	Environmental Responsibility Act. Wildlife Act. Ecological Balance and Environmental Protection Act. Coordinated Energy Regulating Entities Act. LGEEPA: Requires an EIA for all oil and gas activities.	Mining Decree 5.1.4 Article s 79 – 84: Submit Environment control Plan	Health and Safety in Employment (Petroleum Exploration and Extraction) Regulations. Must provide information under the Marine Consenting process	The Petroleum Act Sections 5.1 and 5.2 and Regulation pursuant to the Petroleum Act Sections 43, 45: Impact assessment must contain a description of relevant disposal alternatives and the effect they have on environmental and commercial aspects	The Offshore Petroleum Production and Pipelines (Assessment of Environmental Effects) Regulations 1999 (SI No. 1999/360). Requires impact assessments for offshore oil and gas activities.

<sup>55</sup> Refer to the regulation referenced for additional details and specifics for requirements. This table does not include all specifics for the requirements mentioned.

	UNITED STATES	AUSTRALIA	BRAZIL	CANADA	DENMARK	MEXICO	THE NETHERLANDS	NEW ZEALAND	NORWAY	UNITED KINGDOM
<b>Financial Assurance</b>	<p>30 CFR 556 Subpart I. Lease bond for exploration - \$200,000 – Individual, \$1 million – area wide; for development/production \$500,000 – Individual, \$3 million – area wide. Supplemental/additional bonds will vary case by case basis.</p> <p>30 CFR 556.53(e). The Regional Director will determine the amount of supplemental bond required to guarantee compliance. The Regional Director will consider potential underpayment of royalty and cumulative obligations to abandon wells, remove platforms and facilities, and clear the seafloor of obstructions in the Regional Director's case-specific analysis. Operator may also apply for supplemental bond waiver.</p>	SR 1999 # 228.5F. Demonstration of financial assurance prior condition for acceptance of environment plan (for an activity).	Concession Agreement Clauses 13, 18, 21: Requires that the concessionaries issue a guarantee regarding abandonment operations	Canadian Environmental Assessment Act (CEA): Impact assessment must consider factors including cumulative effects, mitigation measures, and public comments	<p>Model Licence section 30, subsection (1). The model licence, the Licensee's liability for damages under the Subsoil Act shall be covered by insurance.</p> <p>Model Licence Section 21. The licensee shall submit annual financial statements</p>	National Agency for Industrial Safety and Environmental Protection for the Hydrocarbon's Sector Act. The ministry of Finance (SHCP) sets specific conditions of each contract will be set on a case-by-case basis taking into account the risks and costs of the project.	<p>Mining Decree 8.5. Article 122. Amount will be deterred by Minister, and will be increased based on the activities taking place.</p> <p>Mining Decree 8.5. Article 132. With the consent of the Minister of Finance at the expense of a policy article held a multiyear budget reserve.</p>	<p>Crown Minerals Act 2013 - an assessment of an operator's financial capability to carry out their proposed exploration or production activities</p> <p>Crown Marine Protection Rule Part 200 - Financial checks are made to demonstrate that operators have the financial means to undertake their emergency response plans and procedures.</p> <p>Crown Marine Protection Rule Part 102 - Provide evidence of external financial assurance, such as insurance or other financial security, to meet the full costs related to pollution damage to other parties, and costs incurred by public agencies in preventing, controlling, and cleaning up a spill from their installation</p>	The Petroleum Act Section 8. Submit information concerning financial capacity.	The Petroleum Act Part IV Section 38. The Secretary of State may request financial proof that the operator is capable of carrying out the decommissioning procedures as detailed in the abandonment program.



	UNITED STATES	AUSTRALIA	BRAZIL	CANADA	DENMARK	MEXICO	THE NETHERLANDS	NEW ZEALAND	NORWAY	UNITED KINGDOM
<b>Public Consultation</b>	National Environmental Protection Act. Environmental Impact Statements are available for public comment for a minimum of 45 days.	SR 1999 # 228.5C. Publication of an offshore project proposal depending on suitability determined by regulator. Regulator must also publish the decision of the proposal.	-	NEB Act. Guide K.5 – The Board expects applicants will consider consultation for all projects. Sharing contamination remediation plans, if any, with landowners, stakeholders.	Ministry of Climate and Energy. Hydrocarbon Licences. Section 22. It is determined that the Licensee's interest in maintaining confidentiality must yield to considerations of essential public interest	Transparency and Access to Public Information Act.	-	Health and Safety Employment Act 1992 - Depending on the proposal public consultation may be required under submitting a revised safety case.  Resource Management Act 1991. 95A. Activity that will have or is likely to have adverse effects on the environment that are more than minor, and if the applicant requests public notification of the application	Regulations pursuant to The Petroleum Act Section 22: Impact assessment must be submitted for public consultation	Offshore Petroleum Production and Pipelines (Assessment of Environmental Effects) (Amendment) Regulations 2007. Public participation is required for plans and programs relating to offshore oil and gas and the environment.
<b>Removal Guidelines</b>										
<b>Well P&amp;A</b>	30 CFR 250.1715. Generally requires minimum 200 ft long cement plugs to isolate oil, gas, and freshwater zones or to plug casings, with additional bridge plugs or cement retainers allowed or required in some situations.	SLI 2011 # 54.9.13. Requirement for approval for well abandonment. Also submit well completion report and data.	ANP Ordinance No. 25/2002 Chapter 4 Art 19. Cement plugs must be at least 30 m long and the top should be positioned between 100 and 250 m of the seabed.	Abandonment requirements are generally administered by the ERCB, and guidance on these procedures can be found under Directive 013 suspension of wells; Directive 020 well abandonment; and IL 98-02 suspension, abandonment, decontamination and surface land reclamation.	Danish Energy Agency. Guidelines for Drilling – Exploration. 11. Generally requires minimum of 50 meters below and 100 m above cement plugs to isolate perforated zones. Alternatively could use a combination of a mechanical plug squeeze cementing of the perforations and cement plugging above the mechanical plug.	National Agency for Industrial Safety and Environmental Protection for the Hydrocarbon's Sector Act. Develop and execute facilities life cycle program	Mining Regulations 8.5. Generally requires minimum of 100 meters for cement plugs and 50 meters mechanical plug to reservoir or to plug casings, with additional seal required in some situations.	Health and Safety in Employment Regulations 1999 - Generally requires minimum 30 m long cement plugs to isolate oil, gas, and high pressure zones. Surface cement plug of at least 50m in length is placed from below the base of the mud-ooze zone offshore	Facilities Regulations Section 48. Well barriers must be designed so that they take into account well integrity for the longest period of time the well is expected to be abandoned. The barriers must also be designed so that their performance can be verified. NORSOK standard D-010 should be referred to for specific guidelines.	Petroleum Act, amended in the Energy Act, SI1996/913 Offshore Installations and Wells (Design and Construction etc) Regulations 1996 Sections 13 and 15. Wells must be plugged in a way so that there can be no escape of fluids.

	UNITED STATES	AUSTRALIA	BRAZIL	CANADA	DENMARK	MEXICO	THE NETHERLANDS	NEW ZEALAND	NORWAY	UNITED KINGDOM
<b>Structures</b>	30 CFR 250.1728. Platforms and facilities must be removed to at least 15 ft below the mudline. Alternate depths may be approved in some situations.	SLI 2009 #382.2.40. Requires an independent validator to cover evaluation agreed between NOPSEMA and the operator.	ANP Ordinance No. 25/2002 Chapter 4 Art 20. In water depths up to 80 m, all equipment should be removed above the seabed or up to 20 m below the bottom in areas subject to intense erosion.	SOR/2009-315 #59. Not specified	Offshore Safety Act Section 56. Dismantling must be carried out to ensure that the health and safety risks are reduced as much as reasonably practicable.	National Agency for Industrial Safety and Environmental Protection for the Hydrocarbon's Sector Act. Develop and execute facilities life cycle program	Mining Decree. 5.2.4. A mining installation located completely below surface water shall be equipped with a protective construction to prevent damage.	-	NORSOK Standard N-001. Specific decommissioning standards are set under DNV-RP-H102.	1996 No.913 The duty holder shall ensure that an installation is decommissioned and dismantled in such a way that, so far as is reasonably practicable, it will possess sufficient integrity to enable such decommissioning and dismantlement to be carried out safely.
<b>Location Clearance</b>	30 CFR 250.1740. The site must be cleared of all obstructions. A trawl must be dragged across the site for water depths less than 300 ft. For water depths greater than 300 ft, sonar equipment may be used to ensure the site is clear.	OPGGs Act Section 572. Imposes an obligation on the duty holder to remove all structures, equipment and property within the title area.	ANP Ordinance No. 25/2002 Chapter 4 Art 20. In water depths up to 80 m, all equipment should be removed above the seabed or up to 20 m below the bottom in areas subject to intense erosion.	SOR/2009-315 #58. Seafloor is of any material or equipment that might interfere with other commercial uses of the sea.	OSPAR convention 1998. Operators provide proposal for location clearance under decommissioning plan.	National Agency for Industrial Safety and Environmental Protection for the Hydrocarbon's Sector Act. Develop and execute facilities life cycle program	OSPAR convention 1998. Operators provide proposal for location clearance under decommissioning plan.	Maritime Transport Act 1994 - 388 Marine protection rules in relation to harmful and other substances	NORSOK Standard D-010 9.8.2. The location shall be inspected to ensure no other obstructions related to the drilling and well activities are left behind on the sea floor.	Following removal of debris, independent verification survey is required. Undertaken post decommissioning environmental seabed sampling survey to monitor levels of hydrocarbons, heavy metals and other contaminants. Survey strategy will have been agreed with DECC. Submit copies of all debris clearance and survey reports to DECC.

	UNITED STATES	AUSTRALIA	BRAZIL	CANADA	DENMARK	MEXICO	THE NETHERLANDS	NEW ZEALAND	NORWAY	UNITED KINGDOM
<b>Pipelines</b>	30 CFR 250.1751 and 1752. A pipeline may be decommissioned in place after approval by pigging and flushing the pipeline before filling seawater and plugging. The pipeline must then be buried at least 3 ft below the seafloor or have each end covered with protective concrete mats. Prior to removal, pipelines must also be pigged and flushed.	SR 1999 # 228.5A. Submission of an offshore project proposal for decommissioning a pipeline.	-	NEB – Regulating Pipeline Abandonment – A detailed Plan is expected to be filed with an application for abandonment. Flushed & capped.	DEA – Operator’s responsibility. In case of in-situ decommissioning, with appropriate remedial work, the pipelines will remain operator responsibility and will be subject to an agreed monitoring program to ensure the lines remain free of hazards to other sea users.	National Agency for Industrial Safety and Environmental Protection for the Hydrocarbon’s Sector Act. Develop and execute facilities life cycle program	Mining Decree 6.4 Article s 103 and 104. A decommissioned pipeline laid on the continental shelf shall be left behind in a clean and safe condition unless, Minister prescribes its removal. Minister can issue the operator instructions concerning the condition in which the pipeline is to be left behind.	Health and Safety in Employment Regulations 1999. Schedule 4 - Submit pipeline abandonment plan under Safety Case Submittal.	OSPAR Decision 98/3. Does not prohibit the disposal of disused pipelines and cables at sea. Final decisions on the disposal of oil and gas pipelines, are made by the Ministry of Petroleum and Energy	The Pipelines Safety Regulations 1996 Section 14. The operator shall ensure that the decommissioned pipeline is left in a safe condition.
<b>Temporary Abandonment</b>	30 CFR 250.1721. Generally a 100-ft bridge or cement plug must be set. An application to modify must be submitted prior to temporary abandonment.	-	ANP Ordinance No. 25/2002 Chapter 5 Art 25. Cement plugs or buffer must be at least 30 m long and the top should be positioned between 100 and 250 m of the seabed.	SOR/2009-315 #56. Provides isolation of all hydrocarbon bearing and discrete pressure zones, and prevents any formation fluid from flowing through or escaping from the well-bore	Danish Energy Agency. Guidelines for Drilling – Exploration. 11. Generally requires minimum of 50 meters below and 100 m above cement plugs to isolate perforated zones. Alternatively could use a combination of a mechanical plug squeeze cementing of the perforations and cement plugging above the mechanical plug.	-	-	-	Facilities Regulations Section 48. Well barriers must be designed so that they take into account well integrity for the longest period of time the well is expected to be abandoned. The barriers must also be designed so that their performance can be verified. NORSOK standard D-010 should be referred to for specific guidelines.	Petroleum Act, amended in the Energy Act, SI1996/913 Offshore Installations and Wells (Design and Construction etc) Regulations 1996 Sections 13 and 15. Wells must be plugged in a way so that there can be no escape of fluids.

	UNITED STATES	AUSTRALIA	BRAZIL	CANADA	DENMARK	MEXICO	THE NETHERLANDS	NEW ZEALAND	NORWAY	UNITED KINGDOM
<b>Removal (Partial/Full, Full Only, Artificial Reefs)</b>	30 CFR 250.1730. Partial removal or toppling in place may be allowed if the structure becomes part of a State artificial reef program and the structure satisfied the USCG navigational requirements.	The Environment Protection (Sea Dumping) Act 10E. Artificial reefs cannot be placed without a proper permit.	ANP Ordinance No. 25/2002 Chapter 4 Art 20. In water depths up to 80 m, all equipment should be removed above the seabed or up to 20 m below the bottom in areas subject to intense erosion.	SOR/96-118 #43. Where the removal of a fixed offshore production installation is a condition of a development plan approval, the operator shall incorporate in the design of the installation such measures as are necessary to facilitate its removal from the site without causing a significant effect on navigation or the marine environment.	OSPAR Decision 98/3. Requires complete removal.	National Agency for Industrial Safety and Environmental Protection for the Hydrocarbon's Sector Act. Develop and execute facilities life cycle program	Mining Decree 5.1.4 Article 39: Partial or full removal is allowed, and must be specified in removal plan	Health and Safety in Employment Regulations 1999. Schedule 4 - Submit decommissioning proposal for demolishing or dismantling plan under Safety Case Submittal.  Need Environmental Protection Authority ruling when alter, extend, remove, or demolish an existing structure or existing submarine pipeline associated with an activity.	OSPAR Decision 98/3. Requires complete removal (may be possible to request waiver for large structures). NORSOK standard Z-013. Risk analysis assessment will be needed for final disposal of an installation.	OSPAR Decision 98/3. Requires complete removal (may be possible to request waiver for large structures).
<b>Material Disposal</b>	30 CFR 250.1726. Platform or other facility disposal plans must be submitted during initial removal application.	The Environment Protection (Sea Dumping) Act 10B, 10C, 10D. Operators may not dispose of materials without the required permits.	Ordinance 422/2001. An EIA must be prepared for offshore oil and gas activities. Specificity of the EIA will vary depending on the sensitivity of the area being developed.	SOR/2009-315 #6. Submit application for authorization with a description of equipment and procedures	Chemical Substances and Products Act. Soil Contamination Act. Environmental Liability Act. Waste is regulated in integrated environmental permits by Environmental Protection Agency. Special Rules - Statutory order no. 1502 of 2004, Consolidated Act no. 1072 of 2010, Directive 2012/19/EU, & Directive 2000/53/EC.	National Agency for Industrial Safety and Environmental Protection for the Hydrocarbon's Sector Act. "Secondary Laws" of Energy Reform 2014, created National Agency for Industrial Safety and Environmental Protection, which will grant environmental impact authorization.	Mining Decree 5.2.3 Article 62: Operator must submit data detailing how the material was disposed.	Maritime Transport Act 1994 – Submit request to Environmental Protection Authority	The Petroleum Act Section 5.3: The Ministry will determine the appropriate disposal method and the time frame in which the operator must carry it out. The operator is then responsible for ensuring that disposal is carried out as directed. Section 44: Provides specific requirements for decommissioning plan's Disposal.	Petroleum Act 1998 (Guidance Notes). Platform or other facility disposal plans must be submitted with decommissioning programme.
<b>Environmental</b>										

	UNITED STATES	AUSTRALIA	BRAZIL	CANADA	DENMARK	MEXICO	THE NETHERLANDS	NEW ZEALAND	NORWAY	UNITED KINGDOM
<b>Spill Response</b>	30 CFR 250. Oil-Spill Response Plans must demonstrate that the operators can respond quickly and effectively when oil is discharged from the facility. The plan must be submitted prior the facility being used.	SR 1999 #223. Submit a summary of the response arrangements in the oil pollution emergency plan under environmental plan.	Ordinance 422/2001. An EIA must be prepared for offshore oil and gas activities. Specificity of the EIA will vary depending on the sensitivity of the area being developed.	SOR/2009-315 #6. Submit application for authorization with a contingency plans, including emergency response procedures, to mitigate the effects of any reasonably foreseeable event that might compromise safety or environmental protection	Statutory Order on Preparedness in Case of Pollution from Certain Facilities at Sea. Offshore operators are required to develop Oil and Chemical Spill Contingency Plans. The plan needs to be updated and re-approved as activities change.	Hydrocarbon Laws Article 47. Spills are liability of operator.	Mining Decree Disaster control plan - In agreement with Minister rules shall be set by ministerial regulation concerning the use of certain substances or preparations on a mining installation in order to prevent pollution of surface water.	Maritime Transport Act Part 23. Oil spill response strategies must be prepared and kept on file, with reviews at least every 5 years.	Pollution Control Act Sections 49 and 51. Studies required to map-out the risk of pollution in connection with and following decommissioning operations.	The Merchant Shipping (Oil Pollution Preparedness, Response and Co-operation Convention) Regulations 1998 Section 4. Offshore operators must have an oil pollution emergency plan in place prior to any activities are commenced.
<b>Environmental Liability Specification</b>	30 CFR 553. Oil Spill Financial Responsibility (OSFR) for covered offshore facilities is dependent on the worst case oil-spill discharge volume, varying from \$10,000,000 to \$150,000,000. (Also see financial assurance)	The Environment Protection (Sea Dumping) Act 10A, 10B, 10C, 10D, 10E, and 16. Improper disposal, placement of a reef, or harm to the environment will result in penalties.	Concession Agreement Clause 21. The operator is liable for all damages and losses to the environment, which may result in fines and/or penalties.	Oil and Gas Spills and Debris Liability Regulations. Provides the financial liability for oil and gas related spills. Amounts vary by area and size of the spill.	Danish Merchant Shipping Act Section 175 and Order No. 838. Financial liability for oil pollution damage varies by ship size and extent of damage.	Hydrocarbons Law Article 122. The Operator will carry out actions for the prevention and remediation of damages to the environment or the ecological balance caused by their activities, and shall be required to bear the costs involved in the remediation.	Environmental Liability Directive 2004. Framework based on the polluter pays principle to prevent and remedy environmental damage.  Mining Decree 8.2. Article 121. Capitol of at least €250,000 fund is required by the operators.	Maritime Transport Act 1994 - Operators are liable for any incidents that might occur during the disposal process.  Part 102 applies a fixed minimum requirement for all offshore installations, irrespective of the operation's type, possible risk, or the potential impact of a spill. The minimum is currently set at 14 million International Monetary Fund Units of Account, or approximately NZ\$26 million	The Petroleum Act Section 5.4 and Regulations pursuant to the Petroleum Act Section 45A: Operators are liable for any incidents that might occur during the disposal process	The Merchant Shipping (Oil Pollution Preparedness, Response and Co-operation Convention) Regulations 1998 Section 7. Oil pollution offenses will be punishable by a fine not exceeding the statutory maximum.

	UNITED STATES	AUSTRALIA	BRAZIL	CANADA	DENMARK	MEXICO	THE NETHERLANDS	NEW ZEALAND	NORWAY	UNITED KINGDOM
<b>Discharge Permits</b>	NPDES Permit Program. Required for any discharges of pollutants to surface waters	The Environment Protection (Sea Dumping) Act 10A. Materials cannot be discharged into the waters without a permit.	Ordinance 422/2001. An EIA must be prepared for offshore oil and gas activities. Specificity of the EIA will vary depending on the sensitivity of the area being developed.	SOR/2009-315 #6. Submit application for authorization with a description of equipment and procedures	Act on the Protection of the Marine Environment Section 26. Permits must be given prior discharge into the waters.	National Agency for Industrial Safety and Environmental Protection for the Hydrocarbon's Sector Act. "Secondary Laws" of Energy Reform 2014, created National Agency for Industrial Safety and Environmental Protection, which will grant environmental impact authorization.	Article 80.4. Oil containing prohibited. An agreement shall be made with minister to draw up further rules concerning permitted oil-containing discharges.	Exclusive Economic Zone and Continental Shelf (Environmental Effects) Act 2012 (EEZ Act) – Need approval from EPA.	Pollution Control Act. Environmental permits needed from Ministry of Petroleum and Energy.	The Offshore Chemicals Regulations 2002. Offshore operators must apply for permits for discharges during decommissioning activities.
<b>Protection of Natural Resources/Surrounding Environment</b>	Endangered Species Act, Marine Mammal Protection Act, Magnuson-Stevens Fishery Conservation and Management Act: Ensures that marine mammals, fish resources, and endangered marine species are not impacted	Australian Endangered Species Protection Act 1992	Concession Agreement Clause 21. The operator must ensure that no damage occur to the field that they are operating.	Species at Risk Act 2002. Canadian Environmental Assessment Act 2012.	Nature Conservation Act 2004, Planning Act 1992, Marine Environment Protection Act, Fisheries Act, Act on Environmental Objectives, Act on Protection of the Marine Environment 1996, Consolidated Environmental Protection Act No. 698 1998	National Agency for Industrial Safety and Environmental Protection for the Hydrocarbon's Sector Act. Hydrocarbons Act. Environmental Responsibility Act. Wildlife Act. Ecological Balance and Environmental Protection Act. Coordinated Energy Regulating Entities Act. Forest Sustainable Development Act. Prevention and Integral Management of Residues Act. Biosecurity for Genetically Modified Organisms Act.	Flora and Fauna Act of 1998. Environmental Management Act 2004. Marine Pollution Act.	Wildlife Act 1953, Conservation Act 1987, Marine Reserves Act 1971, Marine Mammals Protection Act 1979, National Parks Act 1980, Marine Reserves Act 1971 The site must be remediated to the specifications outlined in the resource consent. Remediation could include removal of infrastructure and regular ongoing monitoring of the surrounding area.	Nature Diversity Act 2009. Nature Conservation Act 1970. Water Resources Act 2000. Wildlife Act 1981	Offshore Petroleum Activities (Conservation of Habitats) Regulations 2001 Reg. 5. Requires the Secretary of State before granting any approval for an activity that is likely to have a significant impact on a site to make a Habitats Regulation Assessment.

	UNITED STATES	AUSTRALIA	BRAZIL	CANADA	DENMARK	MEXICO	THE NETHERLANDS	NEW ZEALAND	NORWAY	UNITED KINGDOM
<b>Environmental Inspection</b>	BSEE IIPD 2012-03. BSEE will conduct scheduled and unannounced inspections to verify compliance with all environmental laws and regulations, lease stipulations, mitigation measures, conditions of approval, and other environmental requirements.	Offshore Petroleum and Greenhouse Gas Storage Act 2006 and Offshore Petroleum and Greenhouse Gas Storage (Environment) Regulations 2009 (Environment Regulations). An environmental inspection program, applied with risk-based methodology.	Ordinance 422/2001. An EIA must be prepared for offshore oil and gas activities. Specificity of the EIA will vary depending on the sensitivity of the area being developed.	Canada – Nova Scotia Offshore marine installations and structures occupational health and safety transitional regulations – Safety device tested by the operator once every 12 months, records maintained for 5 years.	Danish Energy Agency. Guidelines for Drilling - 6. During inspection, inspectors from the Danish Energy Agency may in consultation with the operator require drills for emergency preparedness. DEA carries out Regular and unannounced inspections.	National Agency for Industrial Safety and Environmental Protection for the Hydrocarbon's Sector Act. "Secondary Laws" of Energy Reform 2014, created National Agency for Industrial Safety and Environmental Protection, which will grant environmental impact authorization.	Mining Decree 5.2.1 Article 53: The operator shall periodically check the technical integrity of a mining installation designated for production or storage. The operator shall draw up a checking programme for this purpose every 5 years.	Monitoring and compliance will be carried out by New Zealand Petroleum & Minerals (NZP&M), Environmental Protection Authority (EPA), and WorkSafe New Zealand.	The Petroleum Act. Announced inspections.	The Merchant Shipping (Oil Pollution Preparedness, Response and Co-operation Convention) Regulations 1998 Section 8. The Secretary of State may authorize inspections of offshore installations at any time to ensure compliance with oil pollution preparedness.
<b>Health and Safety</b>										
<b>Decommissioning Specific Employee Health and Safety</b>		SLI 2009 #382.2.30. Submit revision of a safety case because of a change of circumstances or operations.		Canada – Nova Scotia Offshore marine installations and structures occupational health and safety transitional regulations – A management system must be in place for health and safety during dismantling activities.	The Offshore Safety Act Sections 19 and 23. A management system must be in place for health and safety during dismantling activities. A health and safety case will need to be updated for dismantling activities once the procedure is determined.		The general rules of the Working Conditions Act are elaborated upon in the Working Conditions Decree and the Working Conditions Regulation. Few of the specifics under Mining Decree are decommissioning focused. Working Conditions Decree – Submit Health and Safety Document with Risk Identification, evaluation, elimination and reduction, and management.		PSA supervises the safety during all phases of the decommissioning process until the installation is placed onto a vessel. The Municipal Authority carries responsibility for supervision at the demolition yard.	Offshore Installations (Safety Case) Regulations 2005. An Abandonment Safety Case is required prior to any decommissioning activities.

\*DISCLAIMER – The blanks in the table entails that regulation was not found with the resources that were allocated to the project.

## 12.5. Regulatory Gaps

Based on the Regulatory Matrix, US Federal requirements cover most of the requirements noted in regulations around the world. The US requirements seem to be fairly strong in providing definitive removal guidance, which many of the other countries are lacking.

The United Kingdom allows the Secretary of State to provide modifications to a decommission plan or application during the approval process, instead of just approving or rejecting an application as it is written. The US requirements do not specify an allowance for modifications in the approval process.

Although the US tends to have more specific and detailed removal guidance than other countries, Norway and the United Kingdom utilize and reference industry developed guidance documents to cover the specifics. These guidance documents and standards provide a level of detail that is not captured in the US regulatory requirements.

Norway, the United Kingdom, Denmark, and draft Thailand Regulations have decommissioning specific health and safety requirements. Norway, for example, specifies who is responsible for ensuring safe practices at each stage of the material disposal process. The US, while having health and safety activities regulated under OSHA, does not have any requirements called out specifically for decommissioning related activities.

## 12.6. Suggested Modifications

Including provisions that allow the reviewer of a decommissioning or removal plan to include modifications in their approval could help ensure that the removal action is being done in the exact manner BSEE requires, without requiring too much back and forth by rejecting and requiring the operator to submit a new plan.

BSEE might consider utilizing guidance references in removal regulations, similar to what is done in the United Kingdom and Norway, in order to include additional detail in the requirements. This would guide operators referencing the regulations for their removal operations to guidance documents that contain best practices and detailed information on how they should carry out their decommissioning operations.

Decommissioning-specific health and safety requirements would be helpful in ensuring that operators consider the health and safety risks of decommissioning operations and help reduce the number of incidents associated with such operations. Current regulations require decommissioning plans to include environmental impacts, but do not require that the operator explicitly consider health and safety risks.

BSEE should consider the potential for the submission of actual decommissioning cost data to confirm or to improve the reliability of decommissioning cost estimates provided for the determination of the amount of financial assurance required. In the UK, the close-out report includes actual decommissioning cost information.



Planning decommissioning projects requires a review of the design and operational records of the offshore facilities need to be reviewed during. If the operator has a complete set of documents to review, there are fewer uncertainties associated with a decommissioning project and a higher likelihood of successful execution. This is a challenge as some of the platforms change operators many times. BSEE may consider instituting a records retention requirement so that this information is retained by the operator and passed to another operator at the time of transfer of the asset. Some of the key documents include:

- Well completion documents and details of all well work performed. It is critical that all known wellbore problems (tubing obstructions, casing pressure and mechanical integrity issues) be documented.
- Complete original structural drawings including all structural modifications performed after the platform was installed
- As built pipeline survey maps
- Platform installation procedures including lifting weights of the major platform components
- Details of significant equipment removal and additions since the platform was installed
- Platform crane load charts and the most recent crane inspection report which will determine if the crane could be useful during decommissioning work.
- Underwater inspection reports of the platform, pipelines and subsea systems
- Report to indicate if the platform rig and living quarters are useable for platform abandonment work